

Advant Fieldbus 100

User Manual

Power and productivity
for a better world™



Advant Fieldbus 100

User Manual

NOTICE

This document contains information about one or more ABB products and may include a description of or a reference to one or more standards that may be generally relevant to the ABB products. The presence of any such description of a standard or reference to a standard is not a representation that all of the ABB products referenced in this document support all of the features of the described or referenced standard. In order to determine the specific features supported by a particular ABB product, the reader should consult the product specifications for the particular ABB product.

ABB may have one or more patents or pending patent applications protecting the intellectual property in the ABB products described in this document.

The information in this document is subject to change without notice and should not be construed as a commitment by ABB. ABB assumes no responsibility for any errors that may appear in this document.

In no event shall ABB be liable for direct, indirect, special, incidental or consequential damages of any nature or kind arising from the use of this document, nor shall ABB be liable for incidental or consequential damages arising from use of any software or hardware described in this document.

This document and parts thereof must not be reproduced or copied without written permission from ABB, and the contents thereof must not be imparted to a third party nor used for any unauthorized purpose.

The software or hardware described in this document is furnished under a license and may be used, copied, or disclosed only in accordance with the terms of such license. This product meets the requirements specified in EMC Directive 2004/108/EC and in Low Voltage Directive 2006/95/EC.

TRADEMARKS

All rights to copyrights, registered trademarks, and trademarks reside with their respective owners.

Copyright © 2003-2014 by ABB.
All rights reserved.

Release: August 2014
Document number: 3BSE000506-600

TABLE OF CONTENTS

About This User Manual

General	13
Audience	13
Manual Organization	13
Document Conventions	14
Feature Pack	14
Warning, Caution, Information, and Tip Icons	15
Terminology	17
Related Documentation	22
Release History	24

Section 1 - Introduction

Product Overview	25
Advant Fieldbus 100 Redundancy Concept	26
Media Redundancy	26
Communication Interface Redundancy	28
Advant Fieldbus 100 Length Concept	33
Physical Overview	36

Section 2 - Advant Fieldbus 100 Concepts

General	51
Communication Interfaces	53
Advant Controller 70	53
Advant Controller 110	53
Advant Controller 160	53
Advant Controller 400 Series	53

AC 800M	53
S800 I/O Station.....	54
AdvaSoft for Windows.....	54
Advant OPC Server for Advant Fieldbus 100 and AC 100 OPC Server	54
CI626/CI630 Communication Interface	54
CI627/CI630 Communication Interface	57
CI520 Communication Interface.....	59
CI522 Communication Interface.....	59
CI526 Communication Interface.....	61
CI527 Communication Interface.....	62
CI869 Communication Interface.....	62
CI810 Fieldbus Communication Interface (FCI).....	64
Redundant FCI (two CI820 and one Connection Unit TB815).....	65
PM810 Processor Module (Advant Controller 70).....	67
TC501V150 Termination Unit for Twisted Pair Cable	68
BNC Termination Unit for Coaxial Cable	69
Process Data Transfer.....	70
Message Transfer	71
Bus Master Function	72
Network Configuration.....	73
Cable Types	74
Advant Fieldbus 100 Cable Length.....	75
Segments - Max Length for Coaxial, Twisted Pair, and Optical Media	75
Time Delay on Advant Fieldbus 100	78
Calculation of Maximum Bus Length for the Advant Fieldbus 100.....	79
Transmission Principles	83
Synchronization.....	85
Compatibility with MasterBus 90.....	85
 Section 3 - Configuration of Advant Fieldbus 100	
General	87
CDP time out mechanism	87
Double CDP Time-out	88

Communication Interface Functions	89
Communication Interface CI520.....	90
Communication Interface CI522.....	93
Communication Interface CI626/CI627/CI630/CI631.....	97
Communication Interface PM810.....	101
Communication Interface CI810.....	103
Communication Interface CI869.....	106
DataSet Peripheral Communication	108
Defining DataSet Peripherals in the Advant Controller 400 Series	110
Defining DataSet Peripherals in the Advant Controller 70/110/160.....	112
Defining DataSet Peripherals in AC 800M.....	113
Configuring DataSet Peripherals.....	116
Configuration Example	118
Event Set on Advant Fieldbus 100	118
Event Transfer	121
Creating EventSets in Advant Controller 400 Series	124
Creating EventSets in Advant Controller 70/110/160.....	125
Time Synchronization on Advant Fieldbus 100	127
Message Transfer.....	128
Performance and Bus Load	129
Bus Load Calculation on 2000 meters	129
Bus Load Calculation on 8500 meters	135
Bus Load Calculation on 15000 meters	140
Bandwidth fragmentation.....	146
Transmission Constraints	147
Message Transfer Rates.....	148
Station Supervision.....	148
Station Supervision in the Advant Controller 400 Master	148
Station Supervision in AC 100 Series	150
AF 100 Station and Advant Controller 70/110 Station Status information	151
Station supervision in AC 800M.....	154

Section 4 - Installation and Start-up

Modem Installation - General	161
Installing the Network.....	161
Cable Installation - General	162
Installing Twisted Pair Cable	162
Installing Coaxial Cable.....	183
Shielding	189
Connection of optical modem.....	189
Starting an Advant Controller 70	190
Initial Start-up.....	190
Selecting Station Address	191
Restarting Advant Controller 70.....	191
LED Indicators on PM810.....	191
Exchange of a PM810.....	191
Starting an Advant Controller 110 with a CI626/CI627	191
Initial Start-up.....	192
Selecting Station Address	192
Restarting Advant Controller 110.....	192
LED Indicators on CI626/CI627.....	193
Exchange of a CI626/CI627	193
Starting an Advant Controller 400 Series with a CI520/CI522	194
Initial Start-up.....	194
Selecting Station Address	194
Restarting Advant Controller 400 Series	194
LED Indicators on CI520.....	194
Exchange of a CI520.....	195
LED Indicators on single CI522	195
LED Indicators on redundant CI522.....	195
Exchange of a single CI522	196
Exchange of a redundant CI522.....	196
Starting an S800 I/O Station	197
Initial Start-up.....	197
Selecting Station Address	198

Restarting S800 I/O Station	198
LED Indicators on CI810	198
Exchange of a CI810	198
Starting an AC 800M Controller with CI869	199
Exchange of Single CI869	199
Exchange of a Redundant CI869.....	199
Selecting the Station Address.....	200
Extending the Bus.....	200
Extending the Bus cable.....	200
Changing the logical Bus length	200

Section 5 - Maintenance and Fault Tracing

Error Detection In Advant Controller 400 Series	203
Not in Operation.....	203
Restarts during Operation	204
In Operation with Error Indications	205
Advant Fieldbus 100 related System Messages	206
Error Detection In Advant Controller 110/160.....	210
Not in Operation.....	210
Restarts during Operation	211
In Operation with Error Indications	212
Error Detection In Advant Controller 70.....	213
Not in Operation.....	213
In Operation with Error Indications	214
Error Detection In S800 I/O Station	216
Not in Operation.....	216
In Operation with Error Indications	217
Error Detection in AC 800M and CI869	217
Not in Operation.....	217
In Operation with Error Indications	217
DataSet Peripheral Errors	223
Advant Controller 400 Series	223
Advant Controller 110/160 and Advant Controller 70.....	229

AC 800M Controller and CI869	230
EventSet Errors in the Advant Controller 400 Series.....	233

Appendix A - Technical Data

CI520 Communication Interface	235
Front Panel of the Communication Interface CI520.....	235
Technical Data of Communication Interface CI520	236
CI522 Communication Interface	237
Front Panel of the Communication Interface CI522.....	237
Technical Data of Communication Interface CI522	238
CI526 Communication Interface.....	239
Technical Data of Communication Interface CI526	239
Modem Installation	241
CI527 Communication Interface.....	243
Technical Data of Communication Interface CI527	243
CI626 Communication Interface	245
Technical Data of Communication Interface CI626	245
CI627 Communication Interface	248
Technical Data of Communication Interface CI627	248
CI630/CI631 Communication Interface.....	251
Technical Data of Communication Interface CI630/CI631	251
CI869 Communication Interface.....	255
CI810 Fieldbus Communications Interface (FCI).....	256
Redundant S800 I/O Fieldbus Interface	257
CI820 FCI Module.....	257
PM810 Processor Module (Advant Controller 70)	259
Cables	260
Coaxial Cable.....	260
Optical Fiber	262
Twisted Pair Cable	262
Modems.....	266
Coaxial Cable Modem TC625	266
Coaxial/Optical Modem TC630.....	267

Twisted Pair Modem TC512	269
Twisted Pair/Coaxial Modem TC513.....	271
Twisted Pair/Optical Modem TC514	273
Twisted Pair/Twisted Pair Modem TC515	276
Twisted Pair Modem TC516	279

Appendix B - Low Layers of Advant Fieldbus 100

Basic Communication Principles	281
Broadcast	282
Master Frames	282
Slave Frames	283
Data Security	283
Process Data Transfer	284
Message Transfer.....	285
Module Status	286
Bus Master Transfer	286
Event Location.....	288
Starting a new Round	288
Searching for Communication Interfaces.....	288
Serving a Communication Interface.....	290
Completing the Round.....	290
CDP Configuration	290
Updating Communication Interfaces.....	291

About This User Manual

General

This manual provides a general physical and functional description of Advant Fieldbus 100 hardware and provides detailed information for installation, service, and maintenance.

Audience

The manual is intended for ABB personnel as well as for the customers maintenance personnel.

The reader is assumed to be familiar with the Advant Controller 70, Advant Controller 110, Advant Controller 400 Series, AC 800M controller, S800 I/O Stations and/or AC 100 OPC Server, the relevant data base elements, and the Advant Station 140 Engineering Station. For further information, see [Table 2](#).

Manual Organization

This manual contains:

- [Section 1, Introduction](#)

This section presents an overview of this document and the product it describes, Advant Fieldbus 100.
- [Section 2, Advant Fieldbus 100 Concepts](#)

This section introduces the major concepts of the Advant Fieldbus 100 network.
- [Section 3, Configuration of Advant Fieldbus 100](#)

This section presents the configuration of the Advant Fieldbus 100.

- [Section 4, Installation and Start-up](#)
This section describes the installation and start-up procedure.
- [Section 5, Maintenance and Fault Tracing](#)
This section describes the maintenance and diagnostics.
- [Appendix A, Technical Data](#)
This appendix describes the physical features and technical data of different communication interfaces.
- [Appendix B, Low Layers of Advant Fieldbus 100](#)
This appendix describes technical details of the low layers implementing the AF 100 communication. The information presented is not necessary to install and maintain a Advant Fieldbus 100 network. It merely completes the technical description and is intended for the curious reader only.

Document Conventions

In this document, the AF 100 units are generally named without suffix Vx or A unless it is necessary for the functionally described. CI810 is the general term for CI810/CI810V1/CI810V2/CI810A.

For example, if media redundancy is described, and the description for S800 Field Communication Interface (FCI) states that the unit to use is CI810V1/CI810V2/CI810A or CI810V1, it implicitly includes CI810V2/CI810A. For verification, refer to [Table 6](#).

Microsoft Windows conventions are normally used for the standard presentation of material when entering text, key sequences, prompts, messages, menu items, screen elements, etc.

Feature Pack

The Feature Pack content (including text, tables, and figures) included in this User Manual is distinguished from the existing content using the following two separators:

Feature Pack Functionality

<Feature Pack Content>

Feature Pack functionality included in an existing table is indicated using a table footnote (*):

*[Feature Pack Functionality](#)

Feature Pack functionality in an existing figure is indicated using callouts.

Unless noted, all other information in this User Manual applies to 800xA Systems with or without a Feature Pack installed.

Warning, Caution, Information, and Tip Icons

This publication includes **Warning**, **Caution**, and **Information** where appropriate to point out safety related or other important information. It also includes **Tip** to point out useful hints to the reader. The corresponding symbols should be interpreted as follows:



Electrical warning icon indicates the presence of a hazard which could result in *electrical shock*.



Warning icon indicates the presence of a hazard which could result in *personal injury*.



Caution icon indicates important information or warning related to the concept discussed in the text. It might indicate the presence of a hazard which could result in *corruption of software or damage to equipment/property*.



Information icon alerts the reader to pertinent facts and conditions.



Tip icon indicates advice on, for example, how to design your project or how to use a certain function

Although **Warning** hazards are related to personal injury, and **Caution** hazards are associated with equipment or property damage, it should be understood that operation of damaged equipment could, under certain operational conditions, result in degraded process performance leading to personal injury or death. Therefore, **fully comply** with all **Warning** and **Caution** notices.

Terminology

Table 1. Terminology

Term	Description
AC	An abbreviation of Advant Controller (used in figures and tables).
AF 100	An abbreviation of Advant Fieldbus 100 (used in figures and tables).
Advant Controller	Advant Controller refers to Advant Controller 70, Advant Controller 110/160 and Advant Controller 400 Series (Advant Controller 410, Advant Controller 450, and Advant Controller 460).
800xA for AC 100	800xA for AC 100 is a connectivity package integrating Advant Controller 100 Series controllers via Advant Fieldbus 100 to the 800xA System.
AC 100 OPC Server	AC 100 OPC Server provides OPC client applications access to process objects in Advant Controller 100 Series.
AF 100 Station	<p>AF 100 Station is the name of the “stations” on Advant Fieldbus 100.</p> <p>An AF 100 Station is each item connected to the Advant Fieldbus 100, for example, Advant Controller 70, Advant Controller 110/160, Advant Controller 400 Series, S800 I/O Station, or AC 100 OPC Server.</p>
Bus	<p>A bus is the hardware connection between all stations (for example cables, modems), without any protocol. It consist of one or more coaxial cables, twisted pair cables, or optical cables. Bus cables can be redundant on Advant Fieldbus 100, see Figure 9.</p>

Table 1. Terminology

Term	Description
Bus Administrator	A Bus Administrator is a communication interface which has capability to manage the Advant Fieldbus 100. This means control the bus traffic and can be able to generate a new scheme for data sets added to the configuration.
Bus master	The communication interface that currently controls the bus traffic. The bus mastership is switched among the Bus Administrators on the bus.
Bus segment	Part of the Advant Fieldbus 100 built up by one media type, coaxial twisted pair or optical media. An Advant Fieldbus 100 can be built up by several segments where the bus segments are connected with a TC513/TC514/TC515/TC630 modem.
Cable 1	Cable 1 is the bus connected to the upper connector on the communication devices. See Figure 11 .
Cable 2	Cable 2 is the bus connected to the lower connector on the communication interfaces. See Figure 12 .
CDP	Cyclic Data Packet; data packet configured to the communication interface. A CDP is the representation of a Station status, an S800 I/O station, an S800 I/O module and a DataSet Peripheral on the Advant Fieldbus 100.
Coaxial media	Coaxial media comprises modem cables, modems and coaxial bus cables.
Coaxial Modem	A coaxial modem is a device that connects the communication interface with the coaxial bus cable. The CI626 has integrated coaxial modems.
Communication Interface	A communication interface is a device that can communicate on the Advant Fieldbus 100 communication link.

Table 1. Terminology

Term	Description
Communication Link	A communication link is the hardware (for example cables, modems) and the low layers of the protocol that enables the communication interfaces (stations) to exchange data. A communication link can not be redundant on Advant Fieldbus 100.
DAT	Data base element representing an INTEGER, INTEGER LONG or REAL value or 32 BOOLEAN values. The DAT also contains a VALID flag and a NAME string.
DataSet (DS)	Data base representation of a block of data to be transmitted. In MasterPiece 90 and Advant Controller 110/160, the DataSet is used for transmission on MasterBus 90 or Advant Fieldbus 100. DataSet in MasterPiece 200 and in Advant Controller 400 Series is used for transmission on MasterBus 300.
DataSet Peripheral (DSP)	A data set function for communication on Advant Fieldbus 100. In the controller the DataSet Peripheral is represented with a data base element.
Drop Cable	The cable from a communication interface or coaxial modem to the coaxial bus cable.
EventSet	Time tagged events that are sent from an Advant Controller 70, Advant Controller 110/160 to an Advant Controller 400 Series and AC 100 OPC Server.
Grounded 75 Ohm BNC Termination, 75 Ohm BNC Termination	Each coaxial bus segment must be terminated with a 75 ohm BNC terminator in each end and one of the ends must be grounded. The grounded end should be in a cabinet where one or more communication interfaces are located. See also Termination and Grounding of Coaxial Cables on page 188.

Table 1. Terminology

Term	Description
Grounded Twisted pair Termination	Each twisted pair bus segment must be terminated with a terminator in each end and one of the ends must be grounded. The grounded end should be in a cabinet where one or more communication interfaces are located. Also ground the shield on the same place there the terminator ground. See also Termination and Grounding of Twisted Pair cables on page 175.
Modem Cable	The cable from the interface devices to the modems.
Optical Modem	An optical modem is a device that connects the electrical bus with the optical bus fiber cable.
Passive device	A device that does not have a valid configuration, its configuration is different from the bus master.
Redundant Cable	The communication can have redundant cables, that means, from a communication interface there are two physical ways to any other communication interface in the network.
S800 I/O Station	S800 Series I/O station in the Advant family. The station, which interfaces AF 100, is subordinated an Advant Controller and is used to distribute the controller I/O along the bus.
Segment	See Bus segment
Signal address, Signal identity	Unique identifier of cyclic data packet (CDP) on the bus. The signal identity are equal in the sending and receiving CDP.
Station	See AF 100 Station.
Tap Cable	The cable between a twisted pair modem TC512/TC516 or the built in modem in CI627 and the TC505/TC506 connection unit. The tap cable is a part of the twisted pair bus cable.

Table 1. Terminology

Term	Description
Trunk Cable	The main twisted pair cable between stations on the bus. Together the trunk and the tap cables forms the twisted pair bus cable.
Twisted Pair media	Twisted pair media comprises modem cables, modems and twisted pair bus cables
Twisted Pair modem	A twisted pair modem is a device that connects the communication interfaces to the twisted pair bus cable. The CI627, S800 I/O Station and the Advant Controller 70 have integrated twisted pair modems
Twisted Pair to Coaxial modem or vice versa	TC513 is media converter between twisted pair media to coaxial media.

Related Documentation

Table 2. Related Documentation

Title	Description
Advant Controller 70 Version 1.2 (or later) User's Guide	Contains information about the AC 70 system, its design and operation, its capacity and scope. It also contains relevant information about the system hardware.
Advant Controller 110 Version 2.3 (or later) User's Guide	Contains guidelines for installation and using of your Advant Controller System.
Advant Controller 160 Version 2.1 (or later) User's Guide	Shows configuration data for initializing of I/O modules and descriptions belonging to the data base elements (names,...)
Advant Controller 400 Series Product Guides	Contains information about the Advant Controller 400 Series System, its capabilities and limitations.
Advant Controller 460 User's Guide	Contains a description of Advant Controller 460 and its functions. Includes information about configuration, installation, fault tracing, maintenance etc.
S800 I/O General Information and Installation User's Guide	Describes the general installation and configuration for the S800 I/O system
Data Base Elements Advant Controller 70 Reference Manual	Contains instructions and data sheets for all data base elements available for Advant Controller 70.
Data Base Elements Advant Controller 110 Reference Manual	Contains instructions and data sheets for all data base elements available for Advant Controller 110.
Data Base Elements Advant Controller 160 Reference Manual	Contains instructions and data sheets for all data base elements available for Advant Controller 160.

Table 2. Related Documentation (Continued)

Title	Description
Data Base Elements Advant Controller 400 Series, Reference Manual	Contains instructions and data sheets for all data base elements available for Advant Controller 410/450.
OPC Server User's Guide	Describes the Advant OPC Server for Advant Fieldbus 100. Contains information about installation, configuration and maintenance.
OPC Server Advant Fieldbus 100 Interface User's Guide	Describes the standard OPC interface for Advant Fieldbus 100. Contains information about its interface, functionality and limitations.

A complete list of all documents applicable to the 800xA Industrial^{IT} Extended Automation System is provided in Released User Documents, 3BUA000263*. This document lists applicable Release Notes and User Instructions. It is provided in PDF format and is included on the Release Notes/Documentation media provided with your system. Released User Documents are updated with each release and a new file is provided that contains all user documents applicable for that release with their applicable document number. Whenever a reference to a specific instruction is made, the instruction number is included in the reference.

Release History

Table 3. Release History of AF 100 User Guide

Release	Description
3BSE 000 506R0001	The first release for MasterPiece 90 / MasterBus 90.
3BSE 000 506R0101	New name and layout, Advant Fieldbus 100 User's Guide.
3BSE 000 506R0201	Includes information about S800 I/O.
3BSE 000 506R0301	Includes information about TC514, TC515, and CI627.
3BSE 000 506R0401	Includes information about interfaces for full redundant media communication.
3BSE 000 506R0501	Includes information about communication interface redundancy with CI522 bus coupler module and modem TC516 for twisted pair media.
3BSE 000 506R0601	Includes information about redundant FCI for S800 I/O.
3BSE 000 506R701	Includes information about the possibility to use AF 100 over distances greater than 2000 meters (6500 ft.) in CI522, CI810 and CI820.
3BSE 000 506R801	Includes CI527 and updates.
3BSE 000 506-510	Uses ABB template for AC 800M. Includes AC 800M and CI869 updates.
3BSE 000 506-600	Includes minor updates.

Section 1 Introduction

Product Overview

Advant Fieldbus 100 (AF 100) is a high performance fieldbus, which is used for:

- Communication between Advant Controllers
- Communication between Advant Controllers and S800 I/O Stations, AC 800M controllers, AC 100 OPC Server, and the equipments developed and sold by other ABB companies.

In an AF 100 bus, it is possible to reach up to 80 stations within a total physical distance of up to 13300 meters (43300 feet).

Advant Fieldbus supports three transmission media:

- Twisted pair (Twp)
- Coaxial (RG59 and RG11)
- Optical media.

An AF 100 bus can be built up with all the three media, where a part of one kind of media is a specific segment.

The following rules apply to the segments:

- To each twisted pair segment, 32 stations can be connected, and the maximum segment length is 750 meters (2500 feet)
- The coaxial segment can be:
 - 300 meters (1000 feet) with cable RG59 or
 - 700 meters (2300 feet) with cable RG11.
- The optical media is only used in point-to-point communication, and it allows the total length of a bus segment to be up to 1700 meters (5500 feet).
- If back-to-back coupled optical segments are used, it is possible to reach up to a physical length of 13300 meters (43300 feet).

An Advant Fieldbus 100 may be installed with one or two physical bus lines (single or redundant media). Two bus lines are chosen when increased availability is required. The redundant bus line does not enhance the bus bandwidth when both the bus cables are operating.

Advant Fieldbus 100 Redundancy Concept

The Advant Fieldbus 100 redundancy concept contains:

- Media redundancy
- Communication interface redundancy
- S800 I/O Field Communication Interface redundancy.

When redundant media is used, redundancy must be maintained through the whole bus (this comprises of the bus lines as well as connections of the stations to the bus).

Media Redundancy

The Media redundancy includes redundant cable and redundant modems. A media redundant AF 100 is configured and connected as in [Figure 1](#).

The maximum difference in cable length between the redundant cables must be less than 1200 meters between any two stations throughout the whole bus.

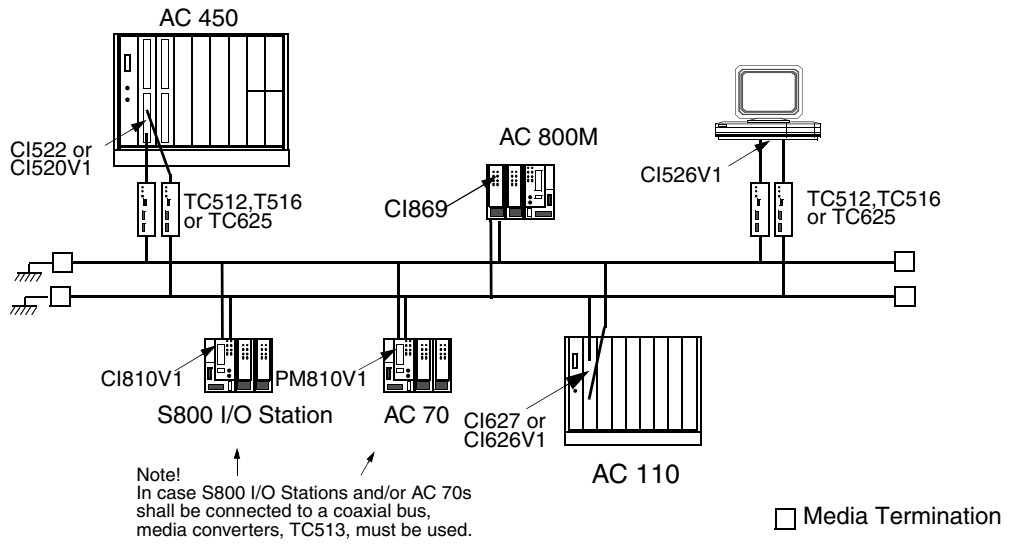

Figure 1. An Advant Fieldbus 100 configuration using redundant media



If the Advant Fieldbus 100 contains one or more of CI520, CI526, CI626, CI810 or PM810 (without the suffix V_x⁽¹⁾ or y⁽²⁾), it is only possible to use redundant coaxial media with a maximum difference of four meters in cable length, between any two stations on the bus. A redundant Twisted Pair or Optical media cannot be used in this case.

(1) V1, V2, V3, and so on

(2) y=A, B, and so on

Communication Interface Redundancy

Communication interface redundancy is achieved by using a pair of CI522s, CI630s, CI631s, CI869s or CI820s, connected to a media redundant bus. Communication interface redundancy is available for Advant Controller 400 Series, Advant Controller 160, AC 800M controller, and S800 I/O stations.

Two communication interfaces (CIs) can operate as a pair, where one is Primary and the other is Backup in the controller configuration.

Functions of Primary CI

In a redundant configuration, the address of the primary CI is the configured station address on the bus.

The primary CI:

- Sends all output CDPs.
- Receives all input CDPs.
- Sends the time synchronization message if the station is configured as time synchronization master.
- Handles the normal Service Data communication for the station.
- Supervises that the backup can send on the bus. This is done at a low frequency using the service data protocol.
- Must be configured as bus master if the module is CI522/CI630 or CI631, so that the bus master responsibilities are performed.

Functions of Backup CI

In a redundant configuration, the address of the backup CI on the bus is the configured station address + 80.

The backup CI:

- Supervises that the primary CI sends its output CDPs properly.
- Sends signal to the controller if the primary CI does not send its output CDPs.
- Receives all input CDPs.
- Responds to Service Data communication with the Primary.
- Must be configured as bus master if the module is CI522, CI630 or CI631. If the station number is less than or equal to 47, the backup module performs the bus master responsibilities, otherwise it does not.

Communication Interface Redundancy in Advant Controller 400 Series

To connect the CI522 redundant communication interfaces to a twisted pair bus, two TC516 modems (or four TC512 modems) are used. See [Figure 2](#).

To connect the CI522 redundant communication interfaces to a coaxial cable bus, four TC625 modems are required.

The TC516 modem has two connections, one for each redundant CI522 and a connection to one twisted pair bus cable. TC516 can be used for two redundant CI522s as well as for one single CI520V1/CI522/CI526V1.

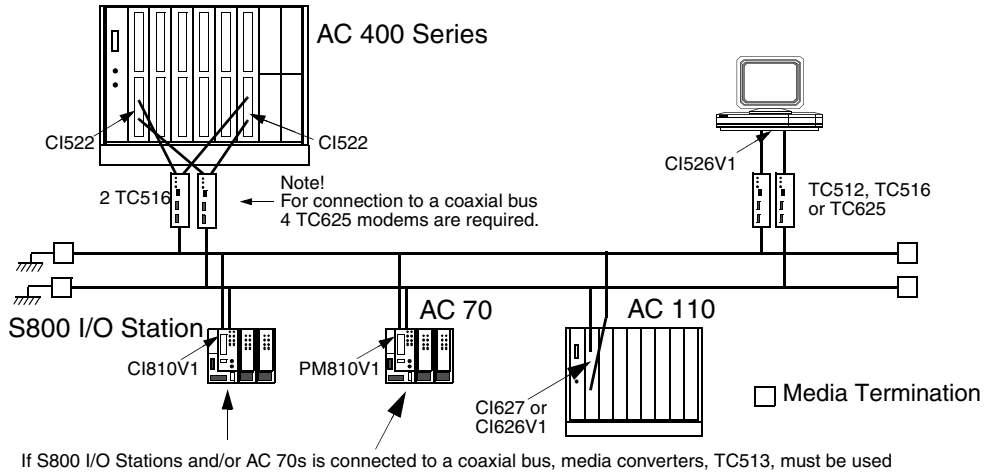

Figure 2. Communication interface redundancy in AC 400 Series

If communication interface redundancy is used, set the DB-element for double time-out. See [Double CDP Time-out](#) on page 88.

Communication Interface Redundancy in Advant Controller 160

For configurations with one Advant Fieldbus 100, the communication interface CI630/CI631 must be placed at position 2 (non redundant interface) or in position 1 and 2 (redundant interface) in the Basic Station.

A second and third Advant Fieldbus 100 can be used with AC 160. These can use single or redundant communication interfaces. The communication interfaces can be placed at position 9 and 10, or 11 and 12, and so on.

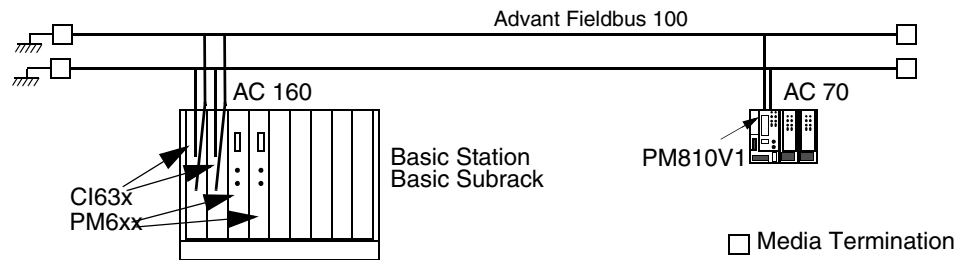

Figure 3. Communication Interface Redundancy in Advant Controller 160

S800 I/O Field Communication Interface Redundancy

The redundancy in the S800 I/O Stations is achieved with redundant Field Communication Interfaces (FCIs) connected to a media redundant Advant Fieldbus 100. In the S800 I/O station, redundancy is achieved with redundant S800 communication interfaces sharing the same I/O modules. This redundancy follows the same principles as the communication interface redundancy in the Advant Controller 400 Series.

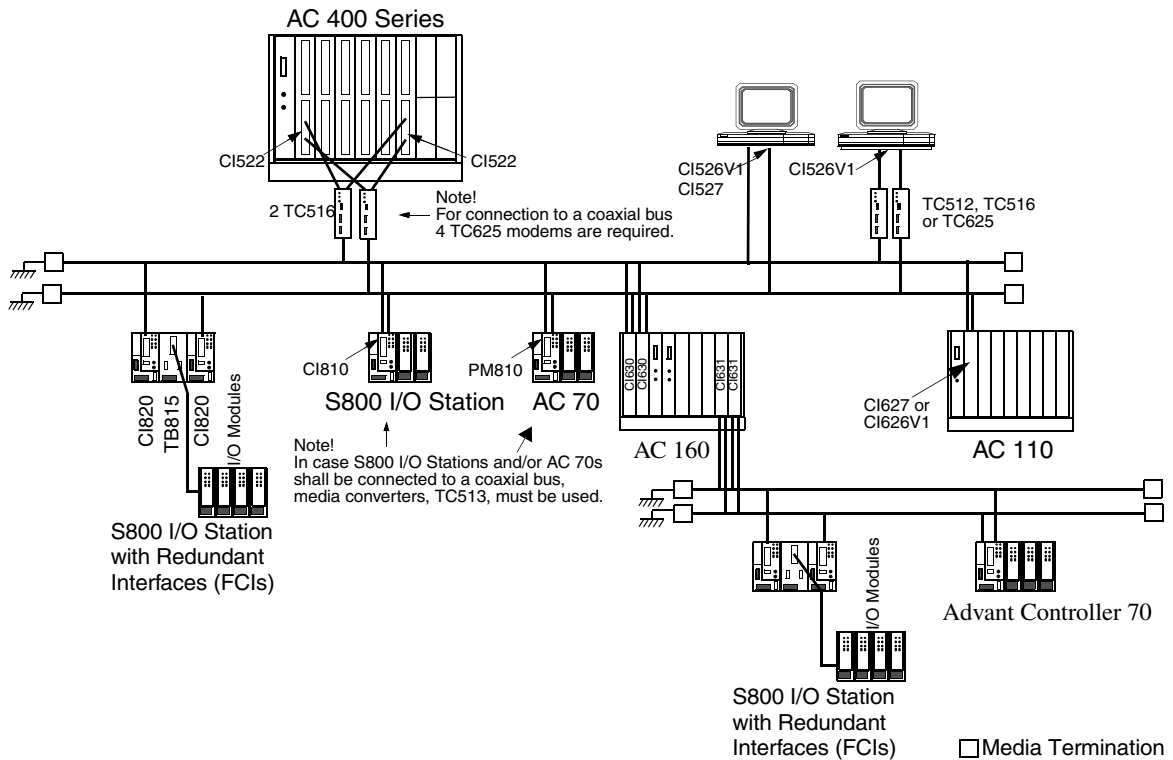

Figure 4. S800 I/O station redundancy on Advant Fieldbus 100

Communication Interface Redundancy in AC 800M

The communication interface redundancy in AC 800M is achieved by using two CI869 modules that are connected to the same AC 800M controller. One of the CI869 modules is configured as primary, while the other is configured as backup.

Failover time for CI869 and Double DSP timeout

The failover time is the time that the backup CI869 takes to function as primary without error, if the primary CI869 does not work properly.

The other stations on the AF 100 bus do not influence the failover of the CI869 modules.

The backup CI869 is supervising that the primary CI869 is sending its CDPs with the expected cycle time. If the backup CI869 detects that the Primary CI869 does not send its CDPs as it should, it triggers the AC 800M controller to perform a failover of CI869.

The 'Double DSP timeout' parameter must be enabled for an AF 100 station that is receiving DSP data from another AF 100 station that uses redundant communication interfaces. For details, refer to the Online Help of Control Builder.

Cable Redundancy and Partner Supervision

In a redundant configuration, the primary and the backup CI869 modules supervise that the communication happens between them.

The backup CI869 supervises that the primary CI869 sends its CDPs as it should. For this, it is required that both the cables that are connected to the backup CI869 have bus traffic.

If any of the cables connected to the backup CI869 are without bus traffic for 10 ms or more, the Partner Supervision is disabled, and:

- If the parameter "Cable" on the CI869 hardware editor is set to *Redundant*, the Partner Supervision not active unit status bit is set on the backup CI869 hardware unit.
- If the parameter "Cable" is not set to *Redundant*, the status bit is not set. However, a warning stating that the Partner Supervision requires redundant lines is displayed during the download of this redundant CI869 configuration to the controller.

Advant Fieldbus 100 Length Concept

The Advant Fieldbus 100 length concept helps to configure the bus for three different lengths and thereby achieve different combinations of physical distance and performance.

The possible lengths for AF 100 bus are:

- 2000 meters (6500 ft., maximum physical distance is 1700 meters).
- 8500 meters (27600 ft., maximum physical distance is 7600 meters). The throughput must be 40% of the throughput on 2000 meters.
- 15000 meter (48750 ft., maximum physical distance is 13300 meters). The throughput must be 15% of the throughput on 2000 meter.

The Advant Fieldbus 100 bus length is set while defining the communication interface.

See [Section 2, Advant Fieldbus 100 Concepts](#), for detailed rules of how to calculate bus length in an Advant Fieldbus 100 network. See [Section 3, Configuration of Advant Fieldbus 100](#) for calculation of performance and bus load.

[Figure 5](#) shows an example of an Advant Fieldbus 100 network with length of 15000 meters.

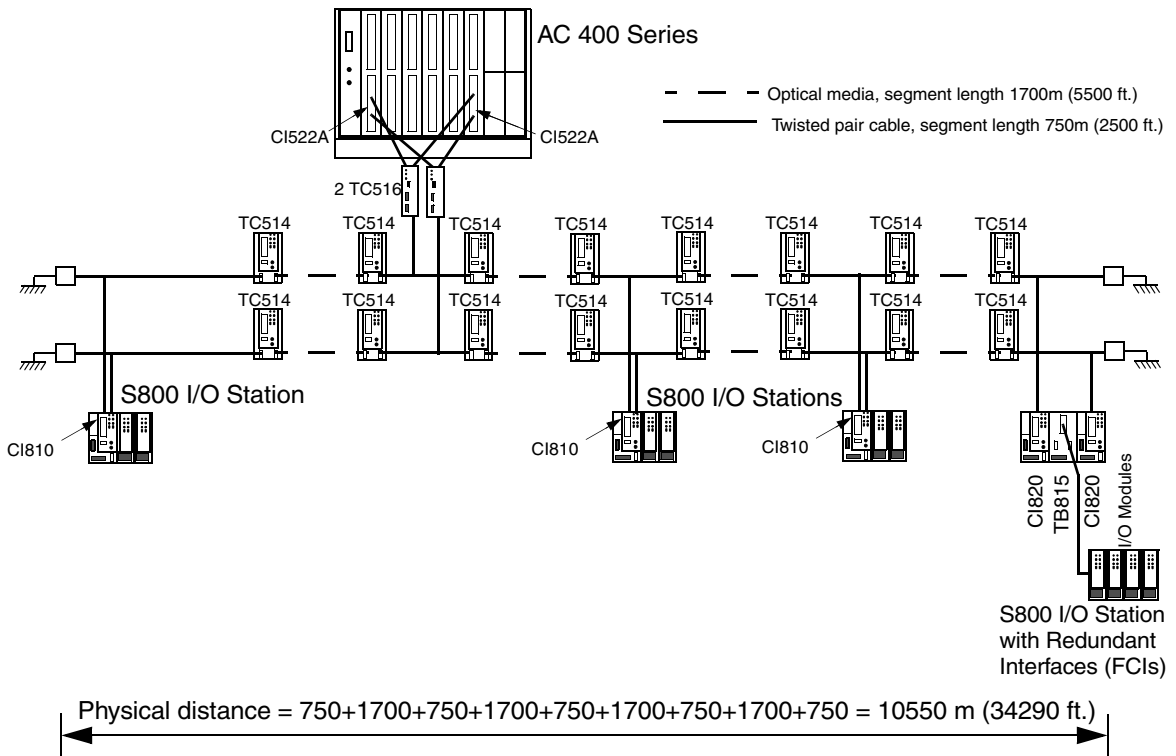

Figure 5. An example of using the Advant Fieldbus 100 length concept for 15000 meter.

In Figure 5, the necessary terminations and groundings are not shown completely.

Table 4 describes the communication interfaces that support the bus lengths of 8500m (27630 ft.) and 15000m (48750 ft.).

Table 4. Communication Interfaces available for bus cable lengths 8500 meters and 15000 meters

Station type	Communication Interface	Base system
Advant Controller 410	CI522A	AC 410 *1.4 or higher
Advant Controller 450	CI522A	AC 450 *2.2 or higher
Advant OPC Server for AF 100	CI527	OPC Server 2.0 or higher
Advant Controller 70	PM810	AC 70 *1.2 or higher
S800 I/O Station	CI810A	CI810 *1.4 or higher
S800 I/O Station (Redundant Field Communication interfaces)	CI820	CI820 *2.1 or higher

Physical Overview

General

A station is connected to the AF 100 bus through a communication interface and a particular modem. Table 5 describes the communication interfaces and modems that are used for the different station types and media.

Table 5. Communication Interfaces and modems for different station types and media

Station type	Coaxial media		Twisted pair media	
	Communication Interface	Modem	Communication Interface	Modem
AC 800M	CI869	TC513	CI869	Integrated in CI869
S800 I/O Station	CI810	TC513	CI810	Integrated in CI810
Advant Controller 70	PM810	TC513	PM810	Integrated in PM810
Advant Controller 110	CI626	Integrated in CI626	CI627	Integrated in CI627

Table 5. Communication Interfaces and modems for different station types and media (Continued)

Station type	Coaxial media		Twisted pair media	
	Communication Interface	Modem	Communication Interface	Modem
Advant Controller 160	CI626/CI630	Integrated in CI626/CI630	CI627/CI631	Integrated in CI627/CI631
Advant Controller 400 Series	CI520/CI522	TC625	CI520/CI522	TC512/TC516
AdvaSoft for Windows *1.x	CI526	TC625	CI526	TC512/TC516
Advant OPC Server for AF 100 and AC 100 OPC Server	CI526	TC625	CI526	TC512§
	CI527	TC513	CI527	Integrated in CI527

Table 6 describes the devices that are used in AF 100.

Table 6. Advant Fieldbus 100 Equipment Items

Equipment Item	Type Designation	Description	Remarks
Advant Controller 70	PM810V2	Processor Module including Advant Fieldbus 100 Communication Interface with Twisted Pair connectors and integrated modem. New compatible Twisted Pair connectors. Supports: Full redundant media	
	PM810V1	Processor Module including Advant Fieldbus 100 Communication Interface with Twisted Pair connectors and integrated modem. Supports: Full redundant media	Replaced by PM810V2
	PM810	Processor Module including Advant Fieldbus 100 Communication Interface with Twisted Pair connectors and integrated modem. No redundant media support	Replaced by PM810V1
Advant Controller 110 & Advant Controller 160 Interface	CI626V1	Interface with coaxial connectors and integrated modem. Supports: Full redundant media	
	CI626	Interface with coaxial connectors and integrated modem. Reduced redundant media support, max 4 meters cable difference between any two station on the bus, on coaxial media only.	Replaced by CI626V1
	CI627	Interface with Twisted Pair connectors and integrated modem. Supports: Full redundant media	

Table 6. Advant Fieldbus 100 Equipment Items (Continued)

Equipment Item	Type Designation	Description	Remarks
Advant Controller 160 Interface	CI630	Interface with coaxial connectors and integrated modem. Supports: Full redundant media Communication interface redundancy support.	
	CI631	Interface with Twisted Pair connectors and integrated modem. Supports: Full redundant media Communication interface redundancy support.	
Advant Controller 400 Series Interface	CI522A	Interface with connectors for special modem cables. Full redundant media support. Communication interface redundancy support. Long distance AF 100 support See Figure 1 , Figure 2 , and Figure 4 .	
	CI522	Interface with connectors for special modem cables. Full redundant media support. Communication interface redundancy support. See Figure 1 , Figure 2 , and Figure 4 .	Replaced by CI522A
	CI520V1	Interface with connectors for special modem cables. See Figure 1 . Full redundant media support	
	CI520	Interface with connectors for special modem cables. See Figure 1 . Reduced redundant media support, max 4 meters cable difference between any two station on the bus, on coaxial media only.	Replaced by CI520V1

Table 6. Advant Fieldbus 100 Equipment Items (Continued)

Equipment Item	Type Designation	Description	Remarks
AdvaSoft for Windows *1.x & Advant OPC Server for AF 100 & AC 100 OPC Server	CI526V1	Interface with connectors for special modem cables. The communication interface is a full length ISA module. Full redundant media support. Full time synchronization capability.	
	CI526	Interface with connectors for special modem cables. The communication interface is a full length ISA module. Reduced redundant media support, max 4 meters cable difference between any two station on the bus, on coaxial media only. Full time synchronization capability.	Replaced by CI526V1
	CI525	Interface with connectors for special modem cables. The communication interface is a full length ISA module. Reduced redundant media support, max 4 meters cable difference between any two station on the bus, on coaxial media only. No Time synchronization SLAVE capability.	Replaced by CI526
	CI527A	Interface with two integrated twisted pair modems. The communication interface is a half length PCI module supporting 5 and 3.3 Volt PCI. Full redundant media support Full time synchronization capability.	
	CI527	Interface with two integrated twisted pair modems. The communication interface is a half length PCI module supporting 5 Volt PCI. Full redundant media support Full time synchronization capability.	Replaced by CI527A

Table 6. Advant Fieldbus 100 Equipment Items (Continued)

Equipment Item	Type Designation	Description	Remarks
S800 I/O Station	CI810A	Fieldbus Communication Interface (FCI) for S800 I/O Stations. Full redundant media support. Long distance AF 100 support, see Advant Fieldbus 100 Length Concept on page 33 for details.	Replaced by CI810B
	CI810B	Fieldbus Communication Interface (FCI) for S800 I/O Stations. Full redundant media support. Long distance AF 100 support, see Advant Fieldbus 100 Length Concept on page 33 for details. New power supply contact.	
	CI810V2	Fieldbus Communication Interface (FCI) for S800 I/O Stations. New compatible Twisted Pair connectors. Full redundant media support.	Replaced by CI810A
	CI810V1	Fieldbus Communication Interface (FCI) for S800 I/O Stations. Full redundant media support.	Replaced by CI810V2

Table 6. Advant Fieldbus 100 Equipment Items (Continued)

Equipment Item	Type Designation	Description	Remarks
S800 I/O Station (continued)	CI810	Fieldbus Communication Interface (FCI) for S800 I/O Stations. No redundant media support.	Replaced by CI810V1
	CI820V1	Redundant Fieldbus Communication Interface (FCI) for S800 I/O Stations. Full redundant media support. Redundant FCI (communication interface) support. Long distance AF 100 support, see Advant Fieldbus 100 Length Concept on page 33 for details. New power supply contact.	
	CI820	Redundant Fieldbus Communication Interface (FCI) for S800 I/O Stations. Full redundant media support. Redundant FCI (communication interface) support Long distance AF 100 support, see Advant Fieldbus 100 Length Concept on page 33 for details.	Replaced by CI820V1
AC 800M Station	CI869	Communication Interface for AC 800M controller. Redundant media support for Twisted Pair (TWP).	

Table 6. Advant Fieldbus 100 Equipment Items (Continued)

Equipment Item	Type Designation	Description	Remarks
Stand Alone Bus Administrator	CI626A	Stand alone Bus Administrator Interface with redundant coaxial connectors and integrated modem. PR:G-PR:J - Full redundant media support PR:B-PR:F - Reduced redundant media support, maximum 4 meters cable difference between any two station on the bus, and on coaxial media only.	
	CI627A	Stand alone Bus Administrator Interface with redundant twisted pair connectors and integrated modem. PR:G-PR:J - Full redundant media support PR:B-PR:F - Reduced redundant media support, maximum 4 meters cable difference between any two station on the bus, and on coaxial media only.	

Table 6. Advant Fieldbus 100 Equipment Items (Continued)

Equipment Item	Type Designation	Description	Remarks
Modems	TC516	Twisted Pair. Provides a connection between CI520/CI522/CI526 and the Advant Fieldbus 100 twisted pair bus. Metal housing.	
	TC515V2	Twisted Pair/Twisted Pair modem. Plastic housing. New power supply connector.	
	TC515V1	Twisted Pair/Twisted Pair modem. Plastic housing. New compatible Twisted pair connectors.	Replaced by TC515V2
	TC515	Twisted Pair/Twisted Pair modem. Plastic housing.	Replaced by TC515V1
	TC514V2	Twisted Pair/Optical Fiber modem. Plastic housing. New switch for selection of 50% or 100% optical output. New power supply connector.	
	TC514V1	Twisted Pair/Optical Fiber modem. Plastic housing. New compatible Twisted pair connector.	Replaced by TC514V2
	TC514	Twisted Pair/Optical Fiber modem. Plastic housing.	Replaced by TC514V1
	TC513V1	Twisted Pair/Coaxial modem. Metal housing. New compatible Twisted pair connector.	
	TC513	Twisted Pair/Coaxial modem. Metal housing.	Replaced by TC513V1
	TC512V1	Twisted Pair. Provides a connection between CI520/CI522/CI526 and the Advant Fieldbus 100 twisted pair bus. Metal housing. New compatible Twisted pair connectors	

Table 6. Advant Fieldbus 100 Equipment Items (Continued)

Equipment Item	Type Designation	Description	Remarks
Modem	TC512	Twisted Pair. Provides a connection between CI520/CI522/CI526 and the Advant Fieldbus 100 twisted pair bus. Metal housing.	Replaced by TC512V1
	TC630	Coaxial/Optical modem. Metal housing.	
	TC625	Coaxial Provides a connection between CI520V1/CI522/CI526V1 and the Advant Fieldbus 100 Coaxial bus. A special connection cable is used for the connection between the interface unit and the modem. Metal housing.	
Termination Unit for Twisted Pair Cable	TC501V150	Termination Unit for Twisted Pair cable. 150 ohm.	
Termination Unit for Coaxial Cable	BNC Termination Connector Unit	Termination Unit for coaxial cable. 75 ohm.	
Connection Unit	TC505	Connection unit used to connect a twisted pair bus. Typically used when the station is mounted in a cabinet where the capacity decoupling is achieved with for example TX507.	
	TC506	Connection unit with capacitive decoupling used to connect a twisted pair bus. Typically used when the station is not mounted within a cabinet	
Connection Cables	TK515	Connection cable for connection between CI520V1 or CI526V1 and modem TC625/TC512/TC516. (1.8 meters (5.6 ft.))	

Table 6. Advant Fieldbus 100 Equipment Items (Continued)

Equipment Item	Type Designation	Description	Remarks
	TK549	Connection cable for connection between CI526V1 and modem TC625. The difference between TK515 and TK549 is, that TK549 got an extra cable to the connector on the modem side, with a power connector adapted, for power support of the TC625 modem.	
	TK593	Connection cable for connection between CI520V1 or CI526V1 and modem TC625/TC512/TC516. (3.6 meter 11.8 ft.)	
	TK803V010	Connection cable for connection between CI522 and modem TC625/TC512/TC516. (1.0 meter 3.0 ft.)	
	TK803V018	Connection cable for connection between CI522 and modem TC625/TC512/TC516. (1.8 meter 5.6 ft.)	
	TK803	Connection cable for connection between CI522 and modem TC625/TC512/TC516. (1.8 meter 5.6 ft.)	Replaced by TK803V018
	TK803V036	Connection cable for connection between CI522 and modem TC625/TC512/TC516. (3.6 meter 11.8 ft.)	

Figure 6 to Figure 9, shows configuration examples of Advant Fieldbus 100.

Figure 6 shows a single twisted pair media configuration with conversion to coaxial media.

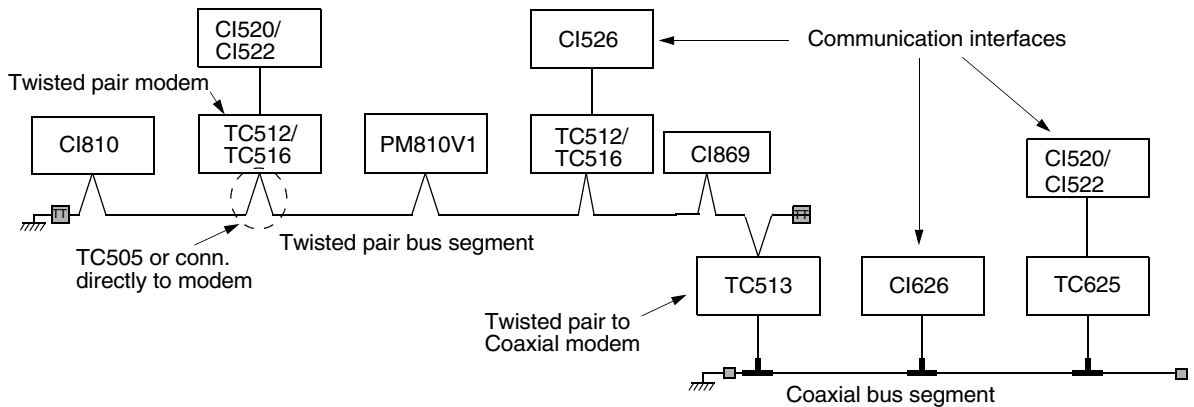

Figure 6. Twisted Pair Media with conversion to Coaxial Media and Name Conventions

Figure 7 shows a redundant twisted pair configuration with conversion to coaxial media.

The figure illustrates that the CI626, CI810, and PM810 has two twisted pair modems integrated and two external TC512/TC516 modems. TC513 modems are required to achieve media redundancy for the CI520/CI526 and for the media conversion.

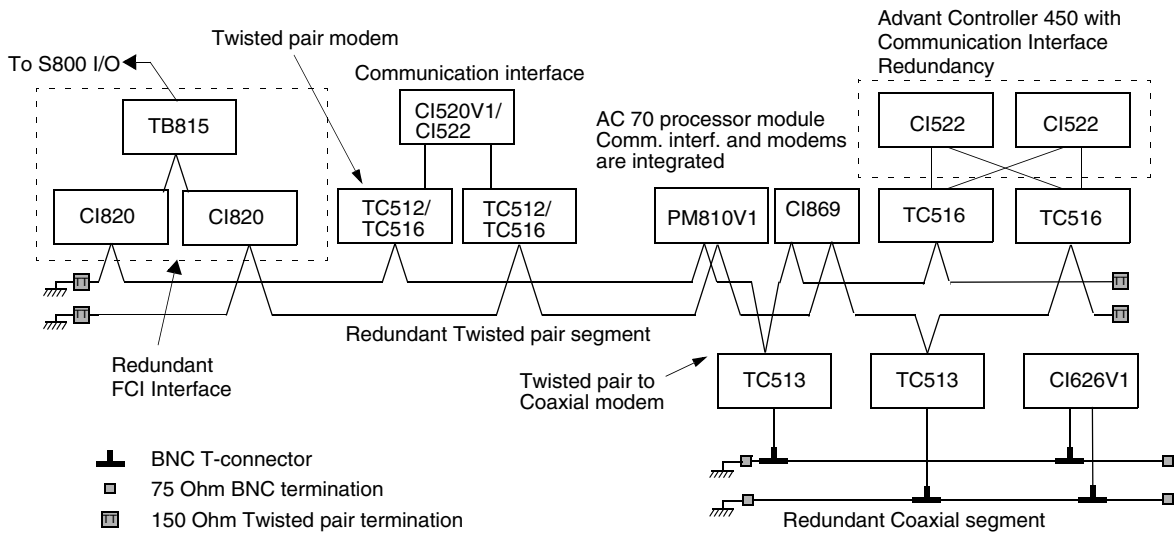

Figure 7. Redundant twisted pair media with conversion to coaxial media

Figure 8 shows two single coaxial segments interconnected with an optical bus segment. The optical fiber is used only in point-to-point configuration.

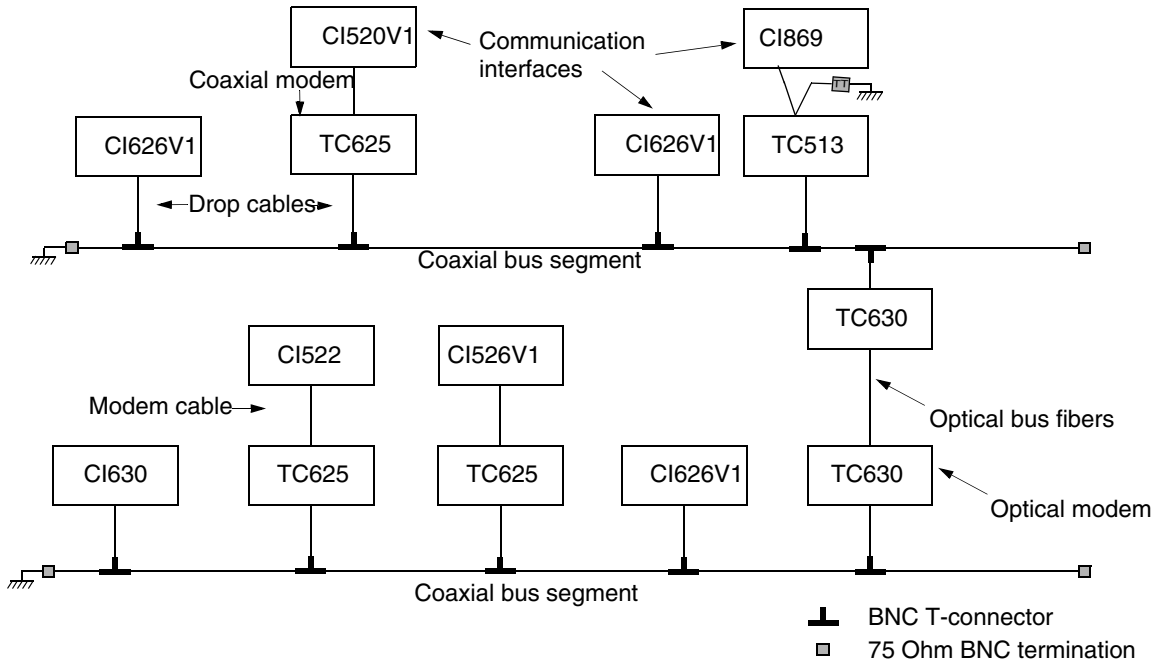

Figure 8. Optical Link between two Coaxial Bus Segment

Figure 9 shows a redundant coaxial segment. The figure illustrates that the CI626V1 (interface unit for the Advant Station 110) has two coaxial modems integrated in the unit.

The other coaxial interface units need two external modems to achieve media redundancy (CI520V1, CI522 and CI526V1).

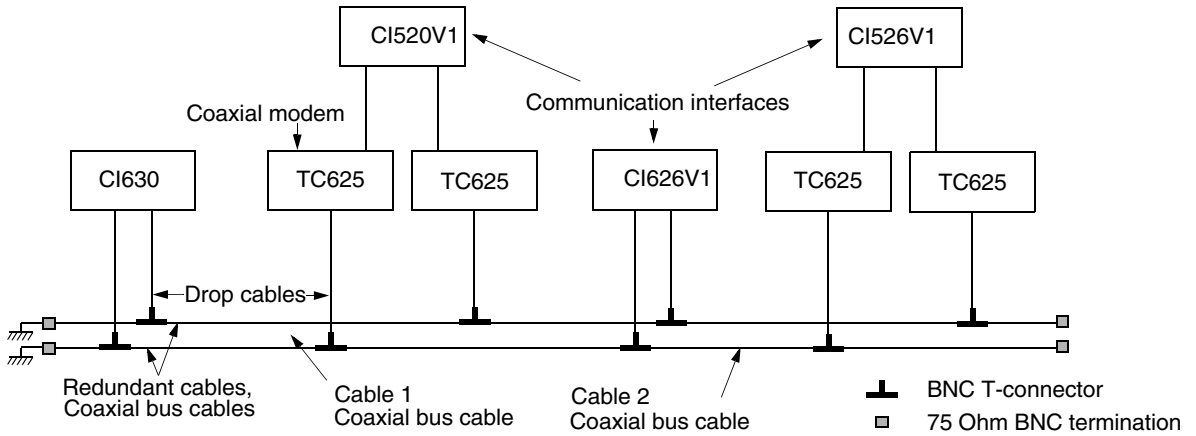

Figure 9. Redundant Coaxial Media

Section 2 Advant Fieldbus 100 Concepts

General

This section describes the components that enable the communication and the concepts of process data and message transfer. The major concepts for the implementation of communication and configuration are also described.

The controllers (Advant Controller 70, Advant Controller 100 Series, Advant Controller 400 Series, and AC 800M) and other AF 100 Stations can be connected as stations on Advant Fieldbus 100. The AF 100 Stations comprise, for example, AC 100 OPC Server and S800 I/O Station. The AC 100 OPC Server provides a wide range of functionalities and when connected to Advant Fieldbus 100, it works as a PC-based operator station. S800 I/O Station is a remote I/O station.

The Advant Fieldbus 100 provides communication between Advant Controllers and AF 100 Stations.

The Advant Fieldbus 100 supports two different kinds of communication:

- Process data—Dynamic data used to monitor and control a process
- Message transfer—Used for parameters, program loading, and diagnostic purposes.

An Advant Fieldbus 100 network is installed with single or redundant cables. In configurations with redundant cables, the data is always transmitted on both cables, but the receiver selects the cable from which it receives the data. This is done automatically by the hardware.

Advant Fieldbus 100 is a high performance fieldbus which can be used to connect up to 80 Advant Controllers and/or AF 100 Stations (see [Figure 10](#)).

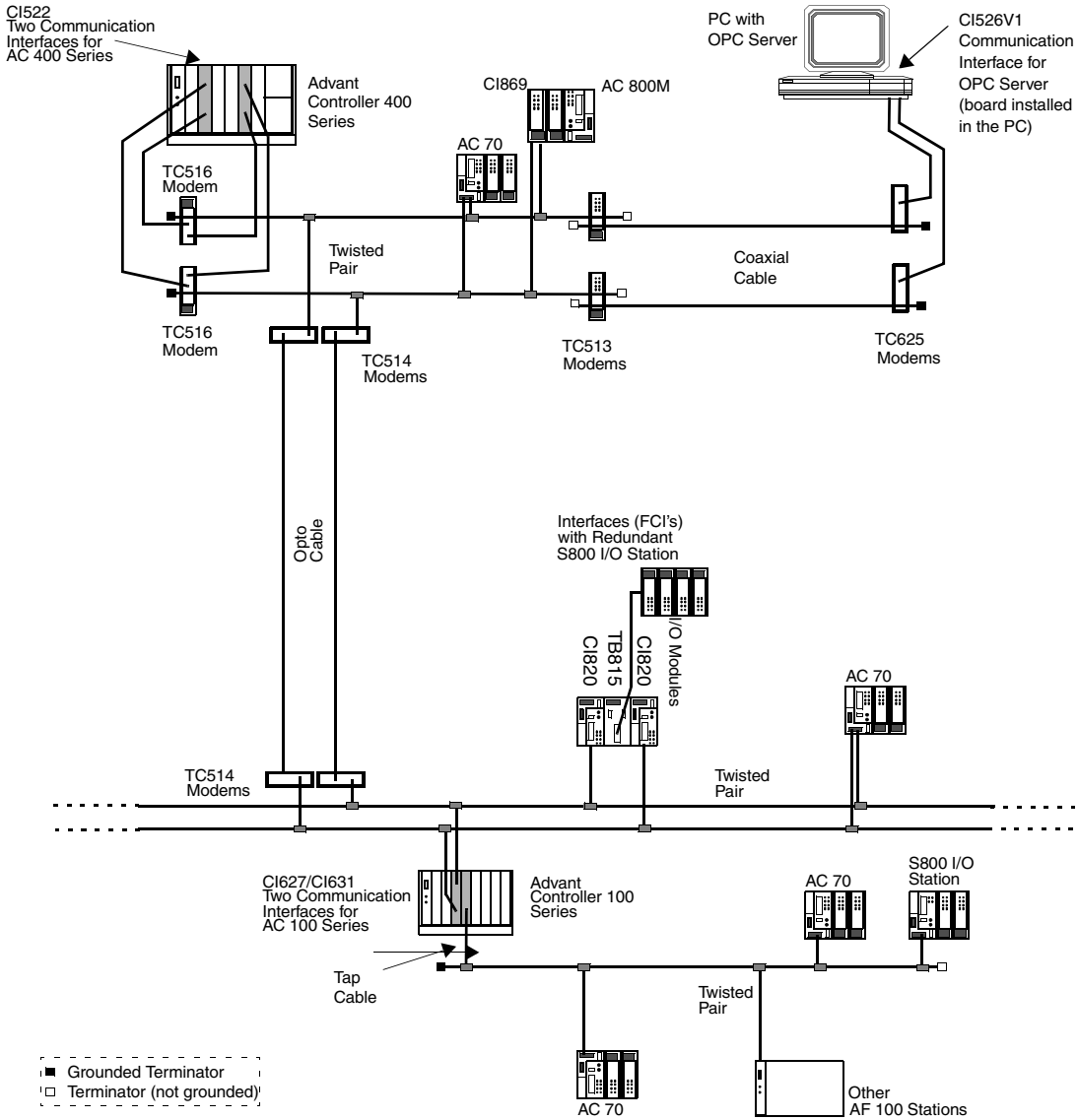

Figure 10. Network Overview - One Redundant media bus and One Single media bus

The allowed station numbers for Advant Controller 400 Series and AC 100 OPC Server are 1 to 80. For other controllers and AF 100 Stations, station numbers 1 to 79 are allowed.

Communication Interfaces

There are several communication components that can communicate on the Advant Fieldbus 100. The communication interfaces that have the capability to be Bus Administrators are CI520, CI522, CI525, CI526, CI527, CI626, CI627, CI630, and CI631.

Advant Controller 70

The Advant Controller 70 has integrated Twisted Pair Modems for connection to Advant Fieldbus 100.

Advant Controller 110

The Advant Controller 110 is connected to the Advant Fieldbus 100 via a CI626 communication interface for coaxial media or a CI627 communication interface for twisted pair media.

Advant Controller 160

The Advant Controller 160 is connected to the Advant Fieldbus 100 via a CI626 or CI630 communication interface for coaxial media or a CI627 or CI631 communication interface for twisted pair media.

Advant Controller 400 Series

The Advant Controller 400 Series is connected to the Advant Fieldbus 100 via single CI520 or via single or redundant CI522 communication interface, and modem TC625 for coaxial media or modem TC512/TC516 for twisted pair media.

AC 800M

The AC 800M controller is connected to the Advant Fieldbus 100 through single or redundant CI869 communication interfaces. The CI869 has integrated twisted pair modems.

The CI869 module along with AC 800M controller does not function as bus administrator on the AF 100 bus. If this station is used, the AF 100 bus requires another station type that functions as bus administrator.

S800 I/O Station

The S800 I/O Station has integrated Twisted Pair modems for connection to Advant Fieldbus 100.

AdvaSoft for Windows

AdvaSoft for Windows is connected to Advant Fieldbus 100 through a CI526 communication interface and a modem – TC625 (for coaxial media) or TC512/TC516 (for twisted pair media).

Advant OPC Server for Advant Fieldbus 100 and AC 100 OPC Server

The OPC Server is connected to Advant Fieldbus 100 through a CI526 or a CI527 communication interface.

When using CI526, one or two TC625 modems (for coaxial media) or TC512/TC516 modems (for twisted pair media) are required.

The CI527 has two integrated Twisted Pair modems. When CI527 is to be connected to coaxial media, a TC513 repeater modem for each bus line is used for media conversion.

CI626/CI630¹ Communication Interface

The Advant Controller 110 is connected to the Advant Fieldbus 100 through a CI626 communication interface. The Advant Controller 160 is connected to Advant Fieldbus 100 through a CI626 or CI630 communication interface (see [Figure 11](#) and [Figure 12](#)).

1. See [Table 6](#) for information about CI626 and CI630 variants

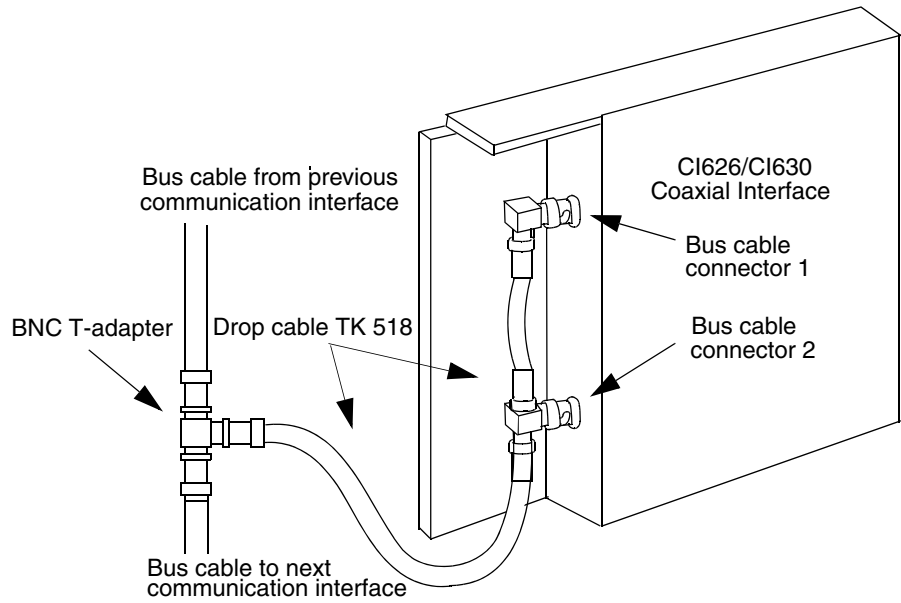

Figure 11. Advant Controller 110/Advant Controller 160 Coaxial Interface with Single Media

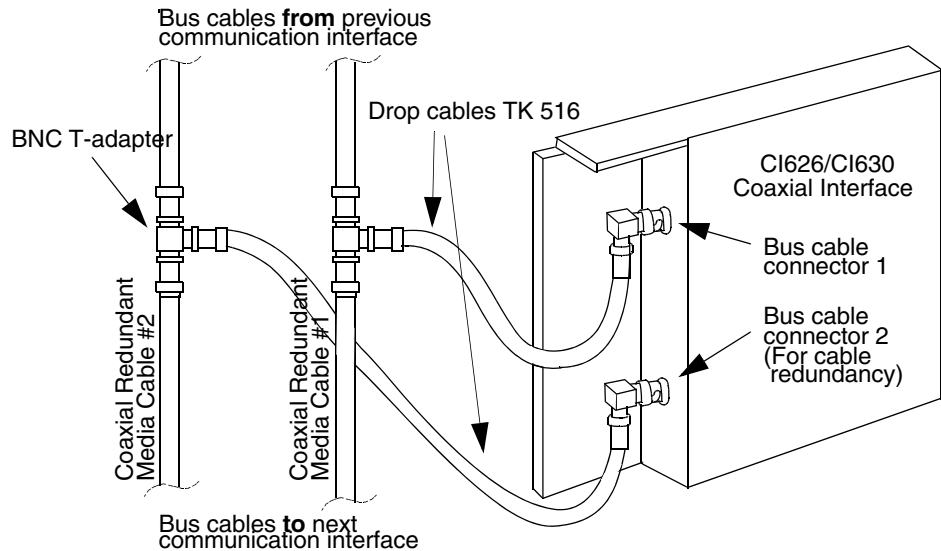

Figure 12. Advant Controller 110/Advant Controller 160 Coaxial Interface with Redundant Coaxial Media

The bus cables are mounted using drop cables with BNC T-adapters that are inserted into BNC bus connectors on the CI626/CI630 communication interfaces (as shown in [Figure 11](#) and [Figure 12](#)).

This method of connection enables the exchange of a faulty CI626/CI630 communication interface without interrupting the communication in the network.



Redundant cables are used to increase the availability; it does not enhance the communication bandwidth.

CI627/CI630¹ Communication Interface

The Advant Controller 110 is connected to the Advant Fieldbus 100 through a CI627 communication interface. Advant Controller 160 is connected to Advant Fieldbus 100 through a CI627 or CI631 communication interface (see [Figure 13](#) and [Figure 14](#)).

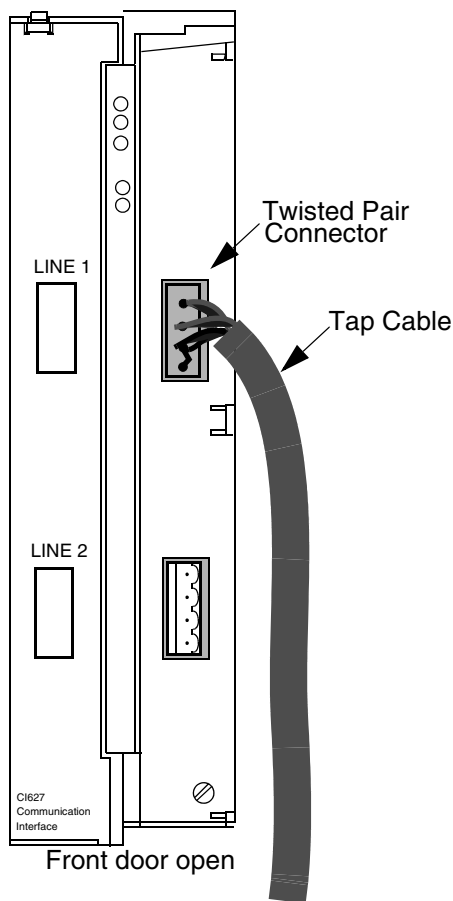

Figure 13. Advant Controller 110/160 Twisted Pair Interface with Single Media

1. See [Table 6](#) for information about CI627 and CI631 variants

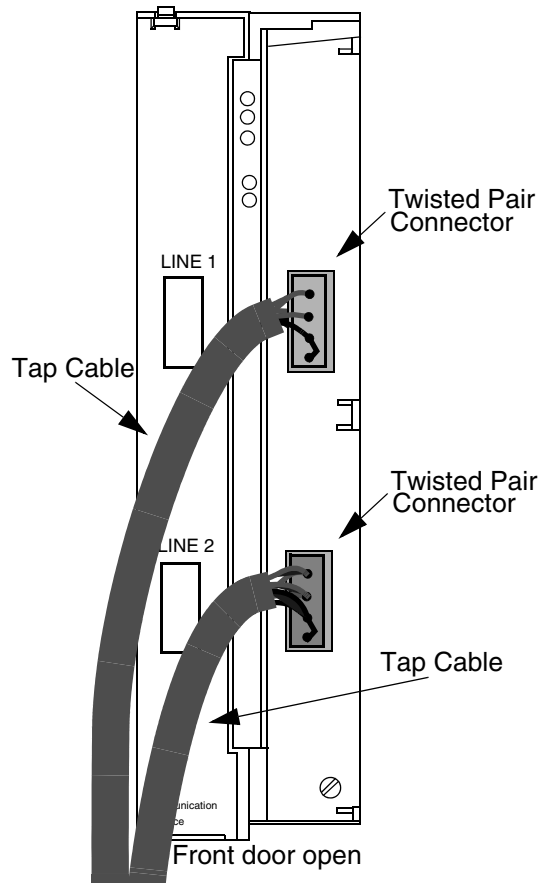

Figure 14. Advant Controller 110/160 Twisted Pair Interface with Redundant Media

The bus cables are mounted using Twisted Pair connectors, which are inserted into bus connectors on the CI627/CI631 communication interfaces (as shown in [Figure 13](#) and [Figure 14](#)).

This method of connection enables the exchange of a faulty CI627/CI631 communication interface without interrupting the communication in the network.



Redundant cables are used to increase the availability; it does not enhance the communication bandwidth.

CI520¹ Communication Interface

Advant Controller 400 Series controllers are connected to the Advant Fieldbus 100 using the communication interface CI520, which is mounted in a submodule carrier module in Advant Controller 450 and in the CPU in an Advant Controller 410. CI520 must always have an external modem, either a TC625 (for coaxial media) or a TC512/TC516 (for twisted pair). The cables that are used between CI520 and the external modem are TK515 (AC 450/AC460) or TK593 (AC 410) (see [Figure 1](#) and [Figure 15](#)).

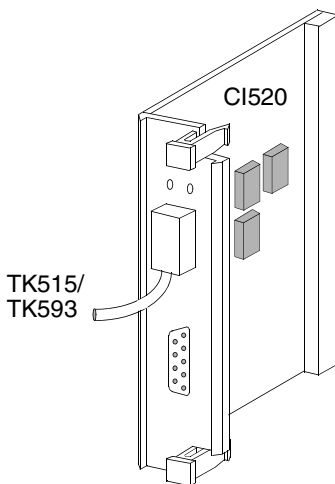

Figure 15. CI520 Communication Interface

CI522² Communication Interface

Advant Controller 400 Series is connected to Advant Fieldbus 100 using the communication interface CI522, which is mounted in a submodule carrier.

The CI522 can be configured as single or redundant, where two CI522s can form a redundant pair.

1. See [Table 6](#) for information about CI520 variants
2. See [Table 6](#) for information about CI522 variants

Communication interface redundancy is achieved by using two CI522s connected to a media redundant bus. CI522 Communication interface redundancy is available for Advant Controller 400 Series. CI522 is mounted in a submodule carrier module in Advant Controller 400 Series. CI522 must always have external modems – TC516 (for twisted pair), TC625 (4 items) or TC512 (4 items). The cables that are used between CI522 and the external modems are TK803V018 (AC 450/AC 460) or TK803V036 (AC 410) (see [Figure 16](#)).

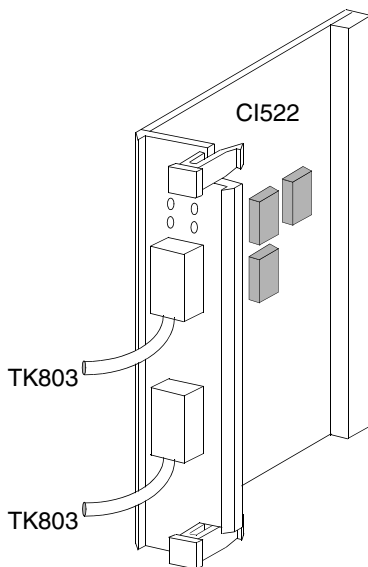

Figure 16. CI522 Communication Interface

CI526¹ Communication Interface

By using AC 100 OPC Server or AdvaSoft for Windows, the communication interface CI526 can be used to connect to Advant Fieldbus 100. CI526 is an ISA module. CI526 must always have an external modem, either TC625 (for coaxial media) or TC512/TC516 (for twisted pair).

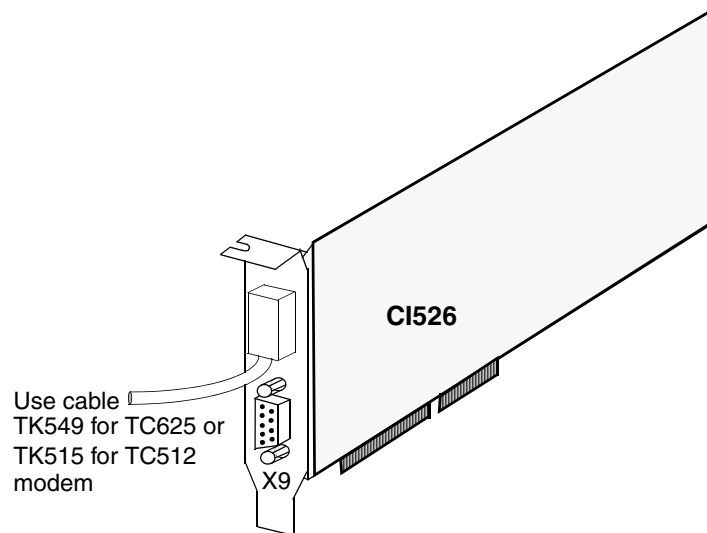

Figure 17. CI526 for AC 100 OPC Server and AdvaSoft for Windows

1. See [Table 6](#) for information about CI526 variants

CI527¹ Communication Interface

To connect Advant OPC Server to Advant Fieldbus 100, the communication interface CI527 can be used. CI527 is a PCI module with integrated twisted pair modems. For connection to coaxial media, TC513 need to be used in a similar way.

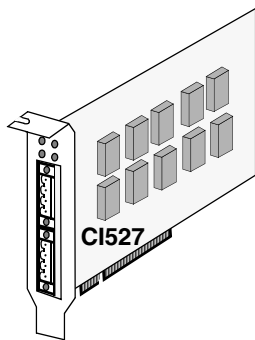

Figure 18. CI527 for OPC Server

CI869 Communication Interface

The communication interface - CI869 - is a CEX Module attached to the AC 800M controller that provides connectivity to other nodes on AF 100. The CI869 provides connectivity through twisted pair (TWP) and has integrated twisted pair modem. For connection to coaxial media, TC513 need to be used.

The CI869 can be configured as single or redundant, where two CI869s can form a redundant pair.

1. See [Table 6](#) for information about CI527 variants

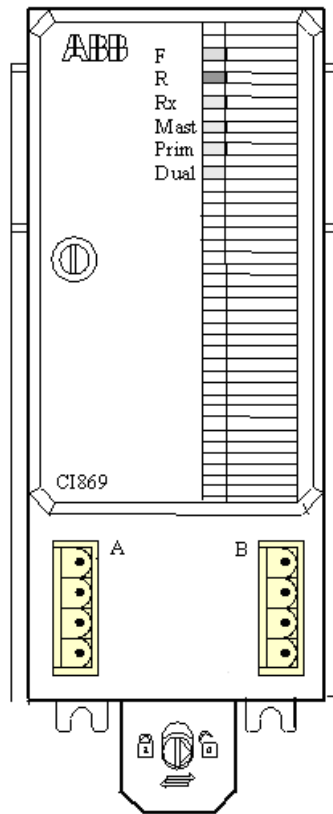

Figure 19. CI869 with two TWP ports for connectivity to AF 100

CI810¹ Fieldbus Communication Interface (FCI)

The CI810¹ Fieldbus Communications Interface (FCI) is a communication interface between an Advant Controller connected to the Advant Fieldbus 100 and the S800 I/O modules connected to the Modulebus.

The termination board is a unit where most of the external connections terminates. It is grounded to the DIN-rail through a metallic spring connector. The board carries screw terminals for power supply and redundant power supply monitoring, and screw terminals for Advant Fieldbus 100 twisted-pair.

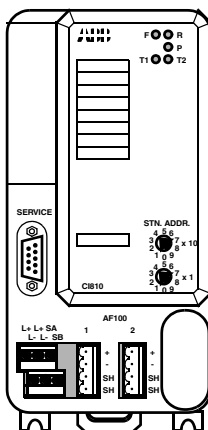

Figure 20. CI810 Fieldbus Communications Interface (FCI)

1. See [Table 6](#) for information about CI810 variants

Redundant FCI (two CI820¹ and one Connection Unit TB815)

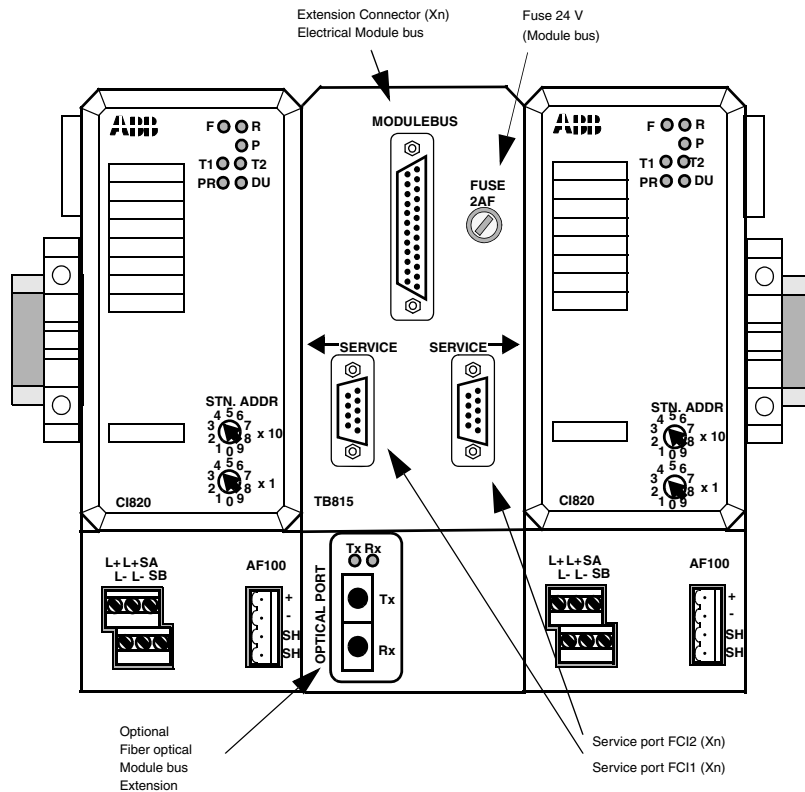

Figure 21. Redundant FCI (two CI820 and one TB815)

The CI820 Fieldbus Communications Interface (FCI) (see [Figure 21](#)), is a communication interface between an Advant Controller connected to Advant Fieldbus 100 and the S800 I/O modules connected to the module bus. It is connected to a pair of redundant Twisted Pair cables (physically one to each CI820).

The TB815 Connection Unit is used to connect the redundant FCI (CI820) together to a unit and to connect them by a Modulebus cable (TC801) or an Opto Link (optional) to the S800 I/O.

1. See [Table 6](#) for information about CI820 variants

The TB815 Connection Unit distributes the signal between the CI820 units, so that both FCI's get electrical inter-connection to both the redundant twisted pair buses. Figure 22 shows the principle of redundant FCI inter-connection.

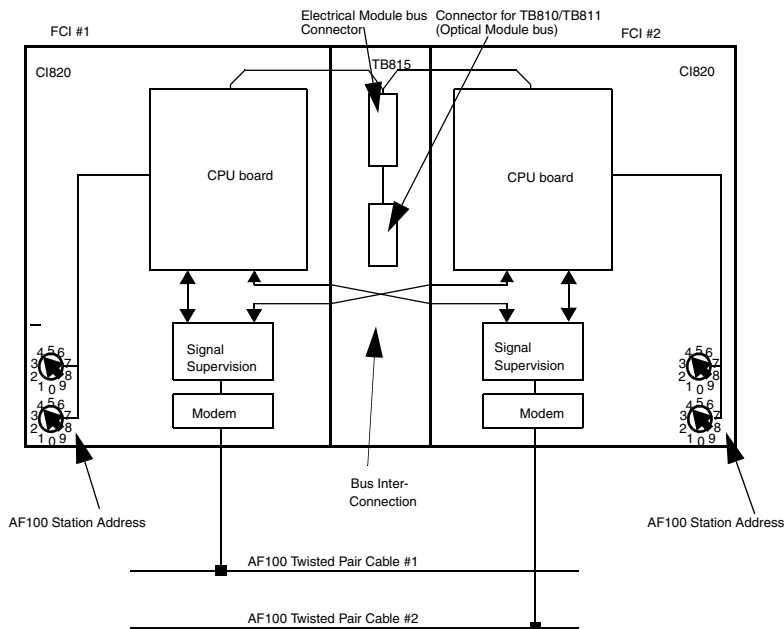

Figure 22. FCI Inter-Connection Principle



Each of the redundant twisted pair cable is connected to an FCI unit (CI820) through the connection unit TB815.

PM810¹ Processor Module (Advant Controller 70)

The Advant Controller 70 station consists of a PM810¹ and S800 I/O modules mounted to a DIN-rail. The Advant Controller 70 station can communicate to an Advant Controller 400/110 station through a single or redundant media twisted pair Advant Fieldbus 100 (see [Figure 23](#)).

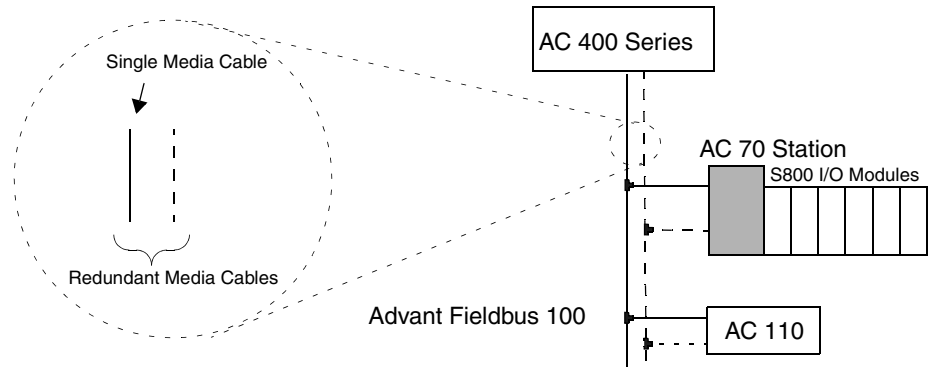

Figure 23. Advant Controller 70 - Overview

1. See [Table 6](#) for information about PM810 variants

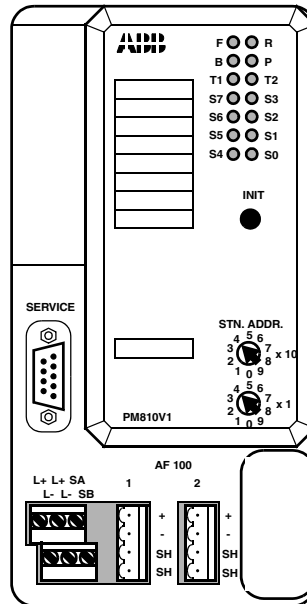

Figure 24. PM810V1 Front Panel

TC501V150 Termination Unit for Twisted Pair Cable

The TC501V150 termination unit is used to terminate the two ends of a twisted pair segment. The termination unit is 150 ohm, and the middle of the active part of the termination unit is connected to a blue cable, which has to be grounded in one end of the segment.

The ends of the termination unit are connected to gray cables, which shall always be connected to the twisted pair cables wires (one to each wire). See [Figure 25](#).

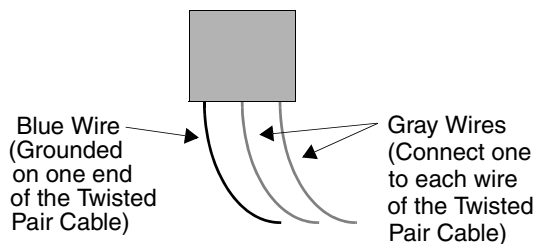

Figure 25. TC501V150 Termination Unit for Twisted Pair Cable

BNC Termination Unit for Coaxial Cable

The BNC termination unit is used to terminate the two ends of a coaxial cable (segment). The termination unit is 75 ohm. One of the two units have a ground cable, which shall be connected to the same grounding rail as the shield of the coaxial cable. See [Figure 26](#) and [Figure 27](#).

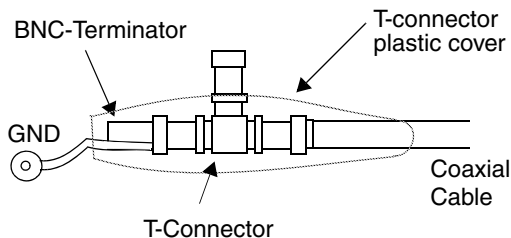

Figure 26. BNC Terminating Plug with Grounding Connection Wire

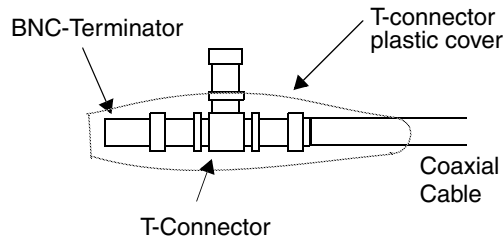

Figure 27. BNC Terminating Plug without Grounding Connection Wire

Process Data Transfer

Process Data Transfer is managed through Cyclic Data Packets (CDPs). Each CDP is configured on the communication interface for a certain signal identity, cycle time, size and direction.

The process data represented by a CDP is always transferred cyclically on the Advant Fieldbus 100.

The signal identity is the common identifier for corresponding send and receive CDPs on the bus. Each CDP has a unique signal identity among the sending CDPs. Several receiving CDPs, however, can have the same signal identity, if they are situated in different communication interfaces.

The cycle time determines how often the data of the CDP is transferred on the bus. When a CDP is transferred on the Advant Fieldbus 100, the interval between consecutive transfers is always the same (the cycle time). Thus the process data transfer does not depend on other tasks that the communication interfaces perform.

The number of data-bytes determines the size of data transferred on the bus. The possible sizes are 2, 4, 8, 16 and 32 bytes. The size of the CDP must be equal at the sending and receiving ends. Unless both the size and the signal address of corresponding CDPs are correct, no transmission is performed.

The direction of the CDP determines whether it is a sending or receiving CDP.

CDPs define a broadcast mechanism where the data contained in one CDP (a sending CDP) is transferred cyclically to another CDP (a receiving CDP), situated in another communication interface in the network. The broadcast mechanism allows several receiving CDPs to be configured to receive data from the same sending CDP (see [Figure 28](#)).

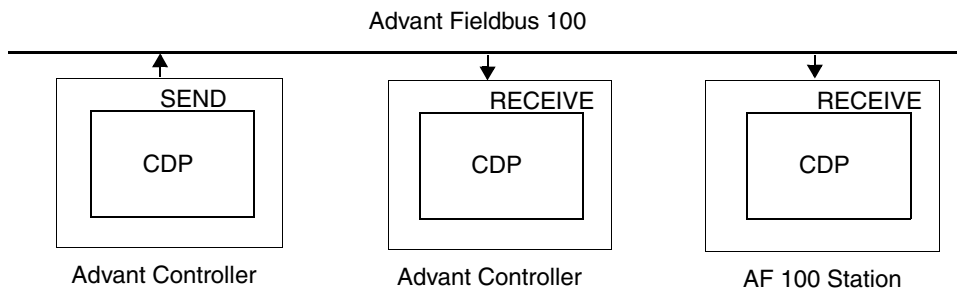

Figure 28. Process Data Transfer

For more information about the configuration and management of CDPs, see [Chapter 3, Configuration of Advant Fieldbus 100](#).

Message Transfer

Message transfer is a point-to-point communication and is sent on request from one station to another station on the AF 100 bus.

Message transfer is used for the transfer of identification data, configuration data, and events between stations on the bus.

Bus Master Function

Both process data and message transfer requires an active bus master. The bus master function controls all the transmission on the Advant Fieldbus 100, while reception of data is controlled locally on the individual communication interface.

In an Advant Fieldbus 100 network with one or more communication interfaces, one of these functions as bus master while the other communication interfaces are active with supervising that the bus master operates correctly.

The bus master responsibility is passed over to the next communication interface on the bus approximately every second (for more information, see [Synchronization](#) on page 85). All the attached communication interfaces with bus administration function share the bus master responsibilities.

As long as the communication interfaces that are attached to the Advant Fieldbus 100 are operational, the bus master function ensures that the process data flows on the bus and that the message transfer is possible.

To ensure a high data availability on the bus, the bus administrators should have as low station address as possible. Each bus administrator supervises that it obtains the master frames on the bus every millisecond. If it does not obtain the master frames for $(8 + 2 * \text{own station address})$ milliseconds, the bus administrator becomes the bus master.



When redundant CI522s, CI869s, and CI820s are used on the bus, then one of the following rules must be followed:

- The redundant CI522 pair must be assigned a station number lower than five (5).
- Two master defined communication interfaces must be assigned station numbers lower than five (5).

There are no specific rules for redundant CI630/CI631, but low station numbers are recommended for bus masters.

Network Configuration

When a new Advant Controller and/or AF 100 Station is connected to the Advant Fieldbus 100, it is automatically recognized and the new element participates in the communication as it is configured. In the Advant Controller 400 Series, the supervision of desired remote stations must be configured.

The starting, stopping, and restarting of stations can also be done without disturbing the traffic on the Advant Fieldbus 100, if some precautions are taken (see [Chapter 4, Installation and Start-up](#)).

However, the communication interfaces of Bus Administrator must know the configuration of all sending CDPs in the network in order to perform the bus master function. Therefore, the information must be distributed to all AF 100 nodes with bus master capabilities when there is any change in the configuration of sending CDPs.

Only sending CDPs need to be considered, as the configuration of receiving CDPs can be controlled locally in communication interface of the receiving CDPs.

The communication interfaces with Bus Administrator capabilities maintain a scan table containing information about all sending CDPs and when they must be transmitted on the Advant Fieldbus 100. When the configuration changes, the scan table is regenerated.

The distribution of information is always performed by the communication interface in which the sending CDP is configured. This is done automatically whenever a sending CDP is defined, deleted, or updated.

Cable Types

The cable types that are used with AF 100 are:

- Coaxial cables:
 - RG59 B/U, 75Ω, (thin) Connectors: BNC
 - RG11 A/U, 75Ω, (thick) Connectors: BNC.
- Twisted pair cables:
 - Trunk cable¹:
Belden - 9182 (Commercial), 1 pair, Stranded conductors,
Belden - 89182 (Plenum), 1 pair, Stranded conductors,
IBM type 1, 2 pair, Solid conductor,
IBM type 1A, 2 pair, Solid conductor.
 - Tap cable²:
Intercond - DK24-02U, 2*2*24AWG
Belden - 1215A, 2 pair, Stranded conductors (electrically IBM Type 6A),
IBM Type 6, 2 pair stranded conductors,
IBM Type 6A, 2 pair stranded conductors
 - Connectors: For example. Phoenix Combicon MSTB 2.5/4-ST-5,08.
- Optical fiber cables:
Dual 62.5/125μ Multimode graded index type,
Connectors: Multimode ST Style.

1. Trunk cable: main twisted pair cable between two stations on the bus - see [Figure 69](#).

2. Tap cable: twisted pair cable from connection unit TC505/TC506 to modem - see [Figure 69](#).

Advant Fieldbus 100 Cable Length

The Advant Fieldbus 100 bus consists of several segments. Two different segments are interconnected with a modem (TC513, TC514, TC515 or TC630).

The advantages of using segments are:

- Reaching distances of up to 13300 meters between the outermost stations on the bus.
- Using different media for different parts of the bus.
- Restoring the bus signals after an electrical disturbance.
- Using more than 32 stations on a twisted pair bus.

Segments - Max Length for Coaxial, Twisted Pair, and Optical Media

The maximum length of each segment on Advant Fieldbus 100 is based on the electrical attenuation of the media of the segment. This ensures that the attenuation does not reach a limit, where it may be impossible for the receiver to read the complete transmitted information because of the attenuation in the media.

The maximum length for:

- RG59 Coaxial cable is up to 300 m (1000 ft.) per segment
- RG11 Coaxial cable is up to 700 m (2300 ft.) per segment
- Twisted pair cable is up to 750 m (2500 ft.) per segment, Communication media according to IEC 1158-2 fieldbus standard.
- Optical fiber is up to 1700 m (5500 ft.) per segment.

Configuration Rules for Twisted Pair media

- Max. cable length = (length of trunk cable) + 3*(total length of tap cables)=750m.⁽¹⁾
- Length of Tap cable: 0 - 10m.⁽²⁾
- Max. number of nodes on a Twisted Pair Cable segment: 32.



Attenuation in a tap cable is 50% higher than in the trunk cable.
A tap cable is intended to be used within a cabinet.

Segments - Minimum Length for Twisted Pair Media

For twisted pair media, the minimum cable length between two modems (for example, TC516 and TC513) or two communication interfaces with integrated modems (for example, CI527 and CI869) is 4 meters (13 ft). This is true also for redundant CI modules in a controller, for example, the cable between a redundant pair of CI869s in an AC 800M controller also needs to be 4 meters.

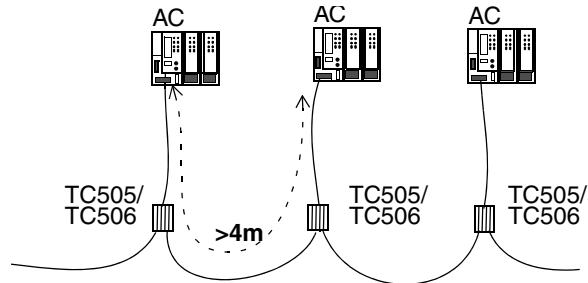

Figure 29. Distribution of Advant Fieldbus 100 stations

The distance between modems can be less than four meters if the total length of the bus segment is less than 10 meters.

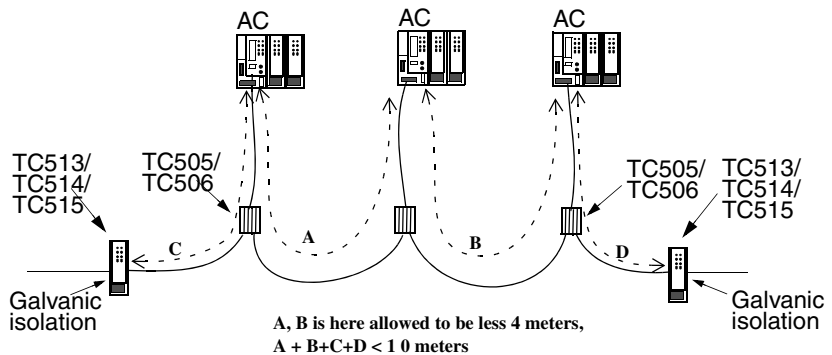

Figure 30. Configuration example with less than 4 meters between stations

Configuration rules for Coaxial media

- Max. cable length:
 - 300 meter (1000 ft.) if coaxial cable type RG59 is used.
 - 700 meter (2300 ft.) if coaxial cable type RG11 is used.
- Max. length of Drop cable: 0.3 meter (1 ft.)
- Max. number of nodes: 80.

Segments - Minimum Length for Coaxial Media

For coaxial media, the minimum cable length between two modems (for example, TC625 and TC513) or two communication interfaces with integrated modems (for example, CI626 and CI630) is 3 meters (10 ft).

For connection between two redundant communication interfaces within a redundant CI522 or CI630 pair, a minimum distance up to 0.1 meter is allowed, if the distance to the next communication interface is 3 meters or more.



There is no minimum required distance between nodes, if:

- Bus-cable is connected directly to the device (that is no drop-cable).
- Total cable length < 10 meter (30 ft.).
- There are only two nodes on the bus.

Segments - Minimum Length for Optical Media

There are no minimum limitations for Optical Media.

Time Delay on Advant Fieldbus 100

Each of the following items causes a time delay equal to 150 meters of AF 100 bus media:

- | | | |
|---------|-------|----------------------------------|
| • TC630 | modem | Coaxial/Optical Fiber modem |
| • TC513 | modem | Coaxial/Twisted Pair modem |
| • TC514 | modem | Twisted Pair/Optical Fiber modem |
| • TC515 | modem | Twisted Pair/Twisted Pair modem. |

Calculation of Maximum Bus Length for the Advant Fieldbus 100

Since there could be time consuming devices such as repeaters on the bus, the maximum physical distance depends on the actual configuration and it is always less than or equal to the logical length.

The formula for calculating the maximum allowed bus length is:

$$\text{Maximal cable length} = 2000 - (\text{Total Number of TCXXX}) \times 150 \text{ (m)}$$

$$\text{Maximal cable length} = 6500 - (\text{Total Number of TCXXX}) \times 500 \text{ (ft)}$$

or

$$\text{Maximal cable length} = 8500 - (\text{Total Number of TCXXX}) \times 150 \text{ (m)}$$

$$\text{Maximal cable length} = 27500 - (\text{Total Number of TCXXX}) \times 500 \text{ (ft)}$$

or

$$\text{Maximal cable length} = 15000 - (\text{Total Number of TCXXX}) \times 150 \text{ (m)}$$

$$\text{Maximal cable length} = 47000 - (\text{Total Number of TCXXX}) \times 500 \text{ (ft)}$$

where *TCXXX* stands for a unit of TC513, TC514, TC515 or TC630.

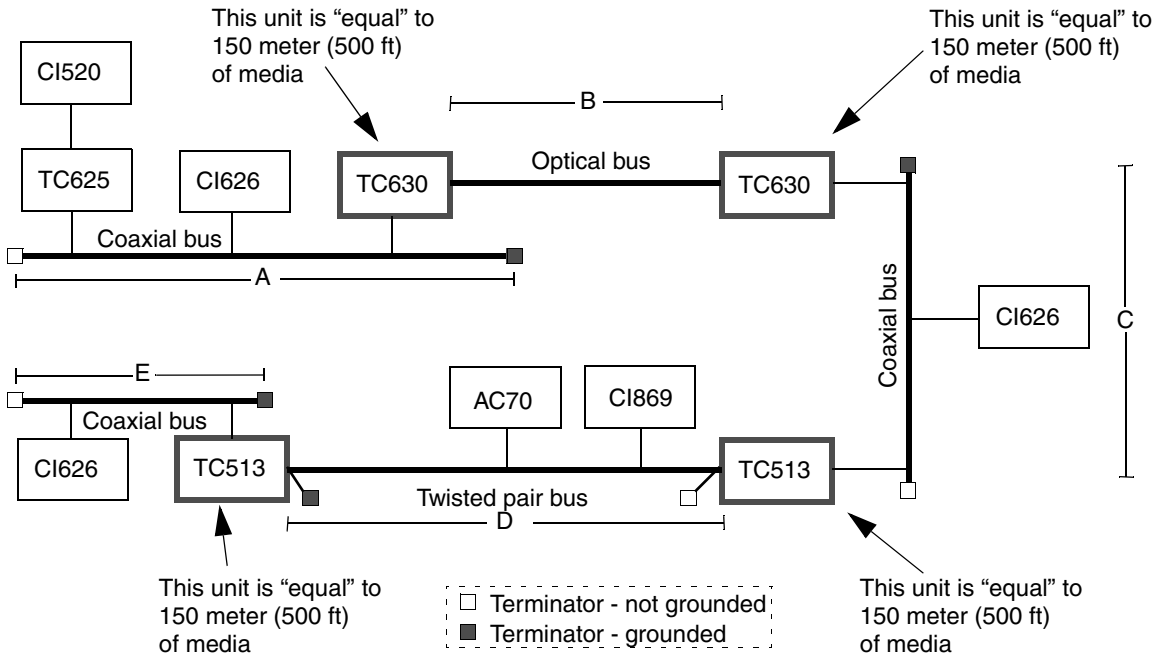

Figure 31. Example - 2000 meter Configuration

Figure 31 shows an Advant Fieldbus 100 bus consisting of three coaxial cables, one optical cable and one twisted pair cable segment.

This gives the following length, for 2000 meters configuration, according to the formula:

$$2,000 - (4 \times 150) = 1400 \text{ meters}$$

or

$$6,500 - (4 \times 500) = 4500 \text{ ft}$$

The total physical cable length (optical cable + coaxial cable + twisted pair cable) in the figure can be up to 1400 meters (4500 ft), according to the calculation above.

This length can be split up between the five different parts, as long as no coaxial cable exceeds the maximum length for the particular type of cable (300 m (1000 ft) or 700 m (2300 ft)).

Therefore, the following restrictions apply:

$$A + B + C + D + E \leq 1400 \text{ meters (4500 ft) and}$$

$$A, C, E \leq 700 \text{ meters (2300 ft) for RG11 or 300 meters (1000 ft) for RG59 and}$$

$$D \leq 750 \text{ meters (2500 ft).}$$



This formula is applicable also for 8500m and 15000m configurations.

For information about equipment supporting these lengths, see [Advant Fieldbus 100 Length Concept](#) on page 33.

When using Advant Fieldbus 100 in the tree configuration, the bus length is the distance between the two stations on the bus that is the farthest apart. This means that the length between different combination of pairs of stations must be considered to decide which two stations are the farthest apart. The same methods for calculating the bus length as well as the possible length is valid both for star configuration and the common bus configuration.

[Figure 32](#) shows an Advant Fieldbus 100 in a tree configuration. The same rules as for [Figure 31](#) is valid when calculating the cable length. The only difference is that the two stations that is the farthest apart is to be used in the calculation.

Therefore, the following restrictions apply:

$$A + B + C + D + E \leq 1400 \text{ meters (4500 ft) and}$$

$$A + B + C + F + G + H \leq 1400 \text{ meters (4500 ft) and}$$

$$E + D + F + G + H \leq 1400 \text{ meters (4500 ft) and}$$

$$A, (C + F), E, H \leq 700 \text{ meters (2300 ft) for RG 11 or 300 meters (1000 ft) for RG59 and}$$

$$D, G \leq 750 \text{ meters (2500 ft).}$$



This formula is applicable also for 8500 and 15000 meter configurations. For

information about equipment supporting these lengths, see [Advant Fieldbus 100 Length Concept](#) on page 33.

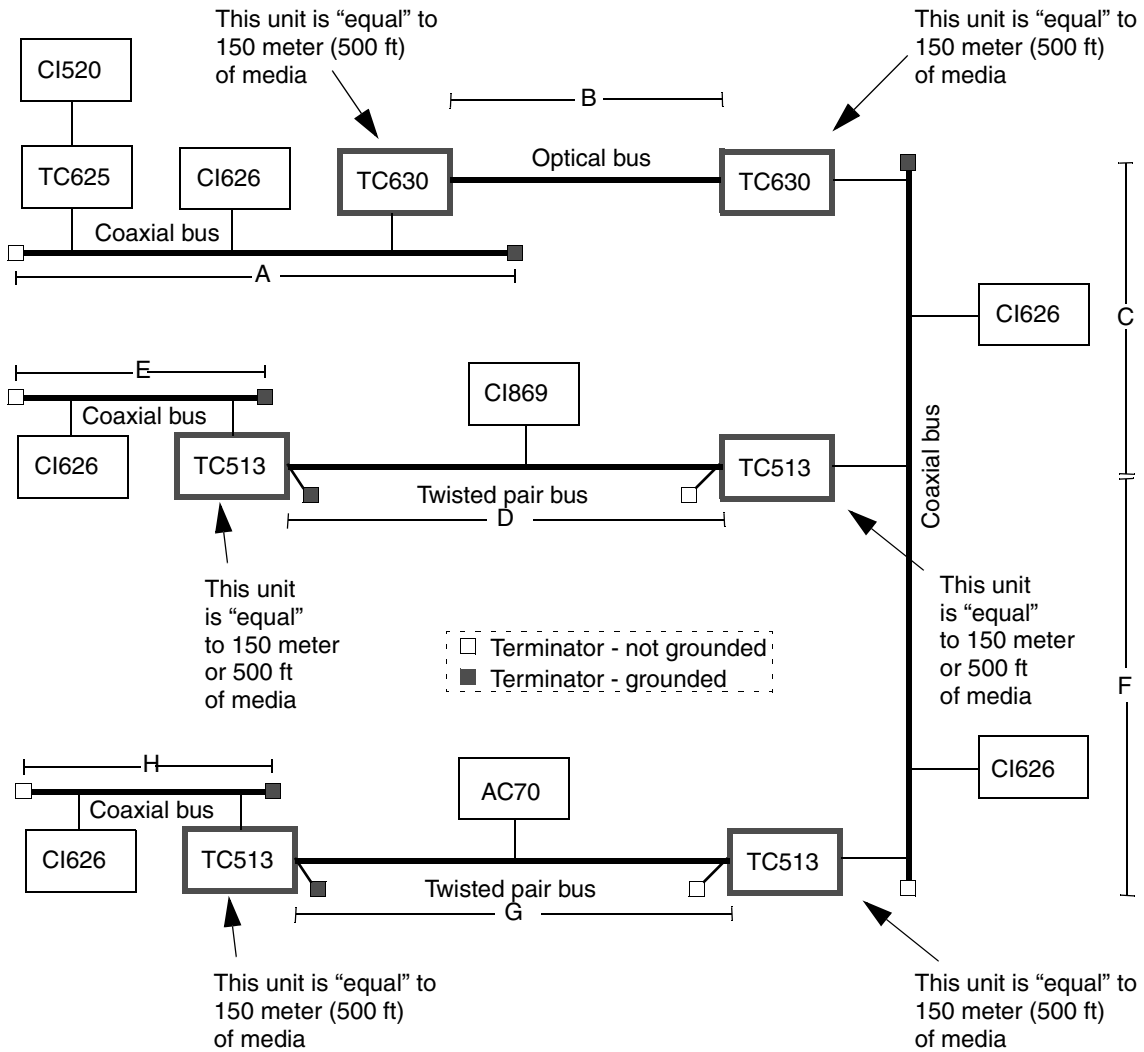

Figure 32. Example - 2000 meter "Tree" Configuration

Transmission Principles

The transmission of a Cyclic Data Packet (CDPs) is managed through a Scan Table. The Scan Table contains information about all sending CDPs and the time at which they must be transmitted on the Advant Fieldbus 100.

The Scan Table is organized in time-slots of one millisecond. Within each time-slot, one or more CDPs may be transmitted.

The message transfer is performed in an event induced manner in time-slots that are not fully occupied with CDP communication. To ensure the message transfer, 25% (for 2000 meters) or 50% (for 8500 meters and 15000 meters) of the time-slots are reserved (see the shaded area in [Figure 33](#) and [Figure 34](#)).

In [Figure 33](#) and [Figure 34](#), the time-slots (one millisecond each) are indicated on the horizontal axis, while the time distribution inside the individual time-slots (that is, which CDP is sent within the time-slot) is indicated on the vertical axis.

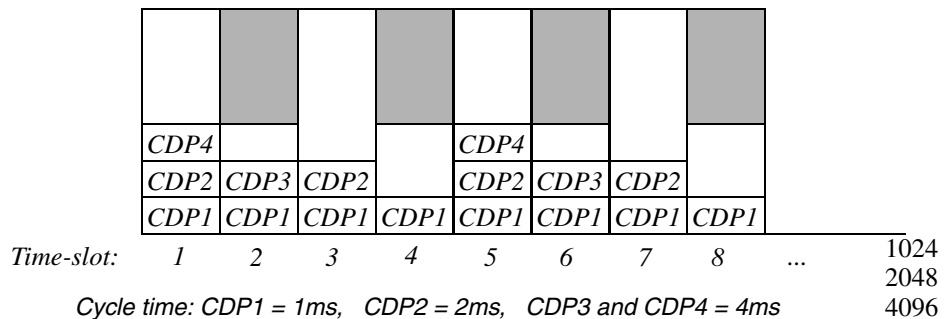

Figure 33. Time-slot organization up to 2000m

In the example in [Figure 33](#), four CDPs are configured. CDP1 has a cycle time of 1 ms, CDP2 has a cycle time of 2 ms, and CDP3 and CDP4 have cycle times of 4 ms. The remaining time (the shaded area in the figure) is used for message transfer, when required.

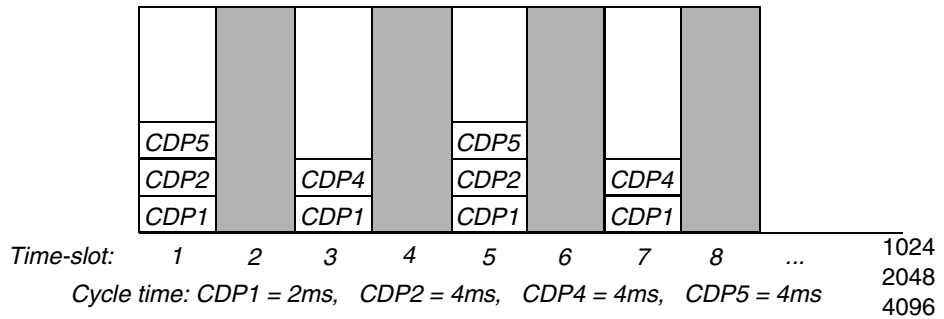

Figure 34. Time-slot organization for 8500m and 15000m

In the example in [Figure 34](#), four CDPs are configured. CDP1 has a cycle time of 2 ms, CDP2 and CDP4 both have 4 ms cycle time. The remaining time (the shaded area in the figure) is used for message transfer, when required.

The size of the master frame depends on the CDP configuration:

- When the CDP cycle time of up to 1024 ms is used, the master frame contains 1024 slots, with up to 18 CDPs per slot.
- With one or several CDPs with cycle time 2048 ms, the master frame contains 2048 slots and up to 12 CDPs per slot.
- With one or several CDPs with a cycle time of 4096 ms, the master frame contains 4096 slots and up to 6 CDPs per slot.

Synchronization

The master communication interface synchronizes with the other communication interfaces attached to the Advant Fieldbus 100, sharing the bus master responsibilities.

This is done by passing the role of bus master to another Bus Administrator every 1024, 2048, or 4096 ms. An exception to this is during configuration, when a Bus Administrator holds the master role for a longer time.

During synchronization, the bus master broadcasts a checksum calculated from the current configuration of dynamic data (scan table). The other bus administrators compares this with the checksum of their own configuration, thus checking the validity of the configuration.

The communication interfaces with the correct configuration only are allowed to participate in sharing of the bus master responsibilities.

Compatibility with MasterBus 90

A MasterPiece 90 may be connected to the Advant Fieldbus 100 through a CI625 module.



The MasterPiece 90 must be updated with the Advant Controller 110 system software.

MasterBus 90 and Advant Fieldbus 100 are slave compatible. The CI625 must not be a bus administrator on the Advant Fieldbus 100. The bus administrator functionality is disabled by resetting the MASTER terminal on the CI625 DB element in the MasterPiece 90.

It is not supported to use Advant Fieldbus 100 equipment on the MasterBus 90. If a MasterBus 90 is to be extended with Advant Fieldbus 100 equipment, it has to be converted to Advant Fieldbus 100.

DataSet Peripherals can not be configured on the CI625 but it is possible to configure up to 100 DataSets on the module. DataSets can also be configured to the CI626 in an Advant Controller 110, but not on the CI520/CI522 in an Advant Controller 400 Series or the on CI525/CI526/CI527 in the AdvaSoft for Windows and AC 100 OPC Server.

In the Advant Controller 400 Series, DataSets can not be defined for the Advant Fieldbus 100.



Redundant line error detection is not used in the slave functionality on the CI625. Therefore, an Advant Fieldbus 100 that uses CI625s must have one AF 100 communication interface placed at each end of the bus for full redundant line error detection.

Section 3 Configuration of Advant Fieldbus 100

General



This section is related to configuration of Advant OCS with Master Software (Advant Controller 410 and Advant Controller 450). For information on how to configure the Advant Fieldbus 100 for Advant OCS with MOD 300 Software, refer to the Advant Controller 460 User's Guide. [Table 12](#) and [Table 16](#) are related to Advant OCS with MOD 300 Software.

A station is connected to the Advant Fieldbus 100 through a communication interface. There are different communication interfaces for each type of station. The communication interface performs several functions in the network, such as managing process data and message transfer, the bus master function, and the configuration of cyclic data packages (CDPs).

The communication interface is configured from the station. The station provides attributes to install the communication interface, make it operational and supervise its performance. This procedure is described in detail in [Section 5, Maintenance and Fault Tracing](#).

CDP time out mechanism

For monitoring CDP data, a time out mechanism is used. CDPs are sent cyclically on the bus. For each CDP, a valid flag is set each time the CDP is received. If the CDP is not received during the last four cycles, the valid flag is reset.



For earlier versions of the communication interfaces, the CDP valid flag is reset after five cycles.

Double CDP Time-out

When using redundant CI522s, CI869s, and CI820s, the partner supervision mechanism needs four cycles of the fastest CDP cycle time used on the bus, to detect that the partner is no longer present.

If the partner is the current primary, within the redundant pair, a switch-over is performed. The switch-over needs extra time, up to several cycles for fast CDPs. The receiving CDPs reaches time out state and are set to non valid in case of a switch-over.

For switch-over handling without the CDPs momentarily being invalid at the switch-over, the CDP time-out for redundant CI522s, CI869s, and CI820s is set to double the value (that is, eight cycles instead of four).



The double CDP time-out is 40 ms for the cycletimes 1 ms, 2 ms, and 4 ms.

The double CDP time-out is required when:

- CDPs with corresponding DSPs must not go to invalid state due to a switch-over.
- S800 I/O is used, and the S800 I/O Modules must not enter OSP state due to a switch-over.

The double CDP time-out must be enabled when:

- Redundant CI522s are defined. Defining both modules in the CI522 DB element enables double time out.
- A CI522 receives data from a controller with redundant communication interfaces. The double time out is enabled when the EN_DTMO terminal on the CI522 DB element is set to 1.
- FCIs subordinated an Advant Controller 450 use, automatically, the same CDP time out as the superior Advant Controller 450.
- A CI869 receives DSPs from a redundant CI522.
- Other stations receive DSPs from redundant CI869 with the cycletimes 1 ms, 2 ms, 4 ms, and 8 ms.

If double CDP time out is not available for a station, the receiving cycle times can be doubled compared to the sending cycle times. This ensures that the CDP does not enter the time-out state.

Communication Interface Functions

After power on (or restart), the communication interface can only become operational if it is set operational by the station.

If the communication interface is not operational:

- It does not provide any transmissions on the Advant Fieldbus 100.
- It cannot share the bus master responsibilities, and it cannot participate in the configuration algorithms of the active scan table.

Communication interfaces defined as bus administrators participate in the bus master responsibilities. As the bus administrators supervise the traffic on the bus and takes over the bus master function if the current master falls out, it is recommended to define communication interfaces as bus administrators, when ever possible.

Communication Interface CI520

Defining Communication Interface CI520

The CI520 communication interface is used in the Advant Controller 400 Series. The DB element for the bus communication interface is shown in [Figure 35](#).

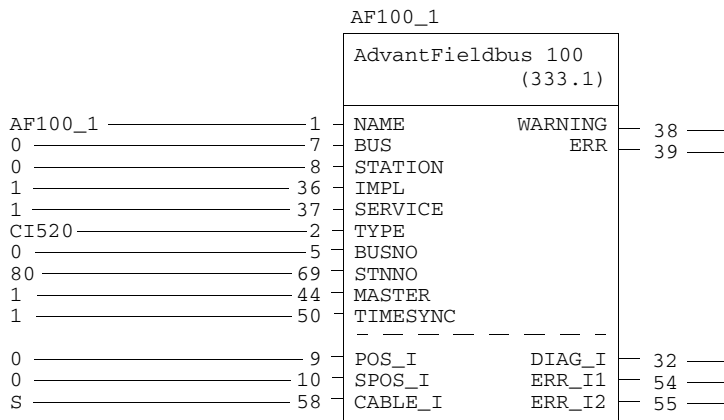

Figure 35. DB element for CI520

Setting the CI520 Operational

When the CI520 is started and configured, it must be set operational to enable communication on the Advant Fieldbus 100, and to participate in the sharing of the bus master responsibilities. This is done automatically by the Advant Controller 400 Series.

If the CI520 is the first communication interface to become operational, it immediately assumes the bus master responsibilities.

If another communication interface becomes bus master before the CI520, the CI520 detects the presence of a bus master on the Advant Fieldbus 100, and get synchronized.

If a CI520 is commanded operational on a bus where other communication interfaces already share the bus master responsibilities, the CI520 sends a message

to the current master to notify its presence. The current bus master then sends the scan table to the CI520 while carrying out the bus master responsibilities. The CI520 adds its own CDPs to the scan table and then asks to become the current bus master. After receiving the bus mastership the new updated scan table is distributed to all other bus administrators.

If a CI520 gets its configuration changed online due to changes in the database, it updates its own scan table and sends message to become the bus master. When it attains the bus master function, the scan table is distributed to all other bus administrators.

Removing a CI520

When the communication interface is to be permanently removed, all sending DSPs must be deleted or redefined. All stations on the bus must be updated by deleting the corresponding receiving DSPs as these will not be updated.

A receiving DSP, configured on the CI520 module to be removed, does not have to be removed from any other station if there is other receiving DSPs with the same identity. If no other station has a receiving DSP, the sending DSP should be deleted from its station as the DSP will be obsolete.

The consequence of not removing the DSPs in question is that the other communication interfaces will keep the CDPs in the scan tables and by this occupying bus bandwidth for no use. As a sending CDP must be deleted from the station by which it is configured, the CDP signal address can not be used by any other station unless the whole bus is restarted. Another drawback of not removing receiving DSPs in other stations is that they will not be updated when the sending DSP or its communication interface has been removed.

For information about replacing the CI520 communication interface with another CI520 communication interface, see [Exchange of a CI520](#) on page 195.

When the sending DSPs have been deleted, perform the following steps in removing the CI520 module:

- Reset the IMPL terminal on the CI520 data base element.
- Remove the modem cable from the CI520 module.
- Remove the CI520 module.

The remaining communication interfaces automatically continue to share the bus master responsibilities between them and ignore the removed station.

CI520 Status Information

The status information of the own communication interface, CI520, is available with the DB element Advant Fieldbus 100.

The status of the CI520 is given by the DIAG_I terminal in the Advant Fieldbus 100 DB element. The following status information is given on the DIAG_I terminal:

- OK** CI520 is operating.
- IE** Missing or faulty CI520.
- PE** Process error, for example cable break.
- ME** CI520 internal error, replace CI520.
- SE** System error, for example several stations are time master.
- DC** Diagnostics has changed.
- PSV** The CI520 is passive.
- DPL** The CI520 only has default parameters.
- I9 - I15** Not yet defined.

Communication Interface CI522

Defining Communication Interface CI522

The CI522 communication interface is used in the Advant Controller 400 Series. The DB element for the bus communication interface is shown in [Figure 36](#).

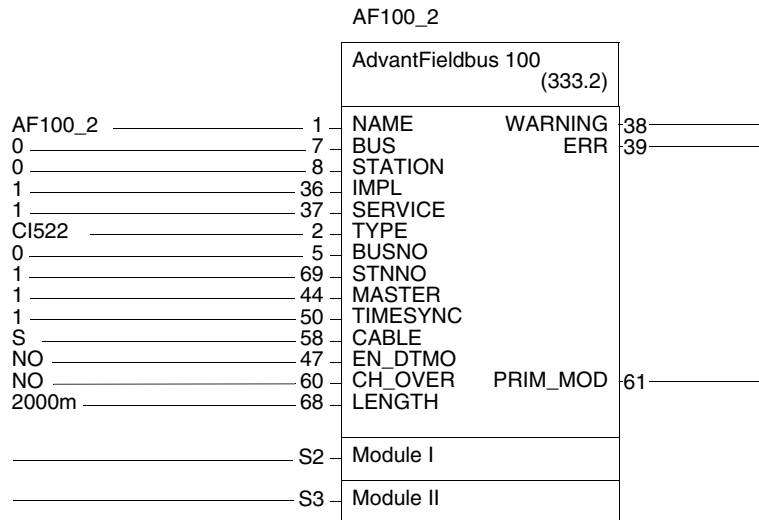

Figure 36. DB element for CI522

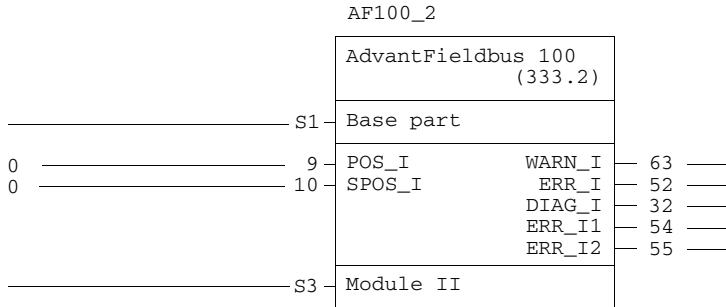

Figure 37. DB element for CI522 - Module I (see Figure 36)

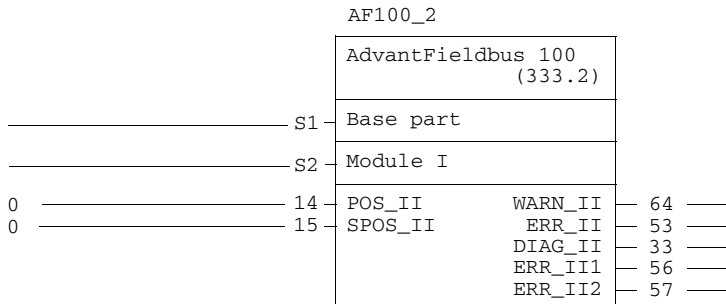

Figure 38. DB element for CI522 - Module II (see Figure 36)

Setting the CI522 Operational

When the CI522 is started and configured, it must be set operational to enable communication on the Advant Fieldbus 100, and to participate in the sharing of the bus master responsibilities. This is done automatically by the Advant Controller 400 Series.

If the CI522 is the first communication interface to become operational, it immediately assumes the bus master responsibilities.

If another communication interface becomes bus master before the CI522, the CI522 detects the presence of a bus master on the Advant Fieldbus 100 and gets synchronized.

If a CI522 is commanded operational on a bus where other communication interfaces already share the bus master responsibilities, the CI522 sends a message to the current master to notify its presence. The current bus master then sends the scan table and the current bus length to the CI522 while carrying out the bus master responsibilities. The CI522 adds its own CDPs to the scan table and then asks to become the current bus master. After receiving the bus mastership, the new updated scan table is distributed to all other bus administrators.

If a CI522 gets its configuration changed on-line due to changes in the database. The CI522 updates its own scan table and then asks to become bus master. When it has become bus master the scan table is distributed to all other bus administrators.

If there is another station (that is bus administrator) on the bus that is configured with a different logical length the CI522 will become operational for a short moment and then leave the operational state. This happens since the bus length currently configured for the bus is distributed to the CI522 by the busmaster and compared with the CI522's own configuration parameters, if they are equal the CI522 remains operational, but if they deviate the CI522 leaves the operational state and turns off all diodes on the front of the board.

Removing a CI522

When the communication interface is to be permanently removed, all sending DSPs must be deleted or redefined. All stations on the bus must be updated by deleting the corresponding receiving DSPs as these will not be updated.

A receiving DSP, configured on the CI522 module to be removed, does not have to be removed from any other station if there is other receiving DSPs with the same identity. If no other station has a receiving DSP, the sending DSP should be deleted from its station as the DSP will be obsolete.

The consequence of not removing the DSPs in question is that the other communication interfaces will keep the CDPs in the scan tables and by this occupying bus bandwidth for no use. As a sending CDP must be deleted from the station by which it is configured, the CDP signal address can not be used by any other station unless the whole bus is restarted.

Another drawback of not removing receiving DSPs in other stations is that they will not be updated when the sending DSP or its communication interface has been removed.

Replacing the communication interface with another CI522 communication interface, see [Exchange of a single CI522](#) on page 196 and [Exchange of a redundant CI522](#) on page 196.

When the sending DSPs have been deleted, perform the following steps in removing the CI522 module:

- Reset the IMPL terminal on the CI522 data base element.
- Remove the modem cable from the CI522 module.
- Remove the CI522 module.

The remaining communication interfaces will automatically continue to share the bus master responsibilities between them and ignore the removed station.

CI522 Status Information

The status information of the own communication interface, CI522, is available with the DB element Advant Fieldbus 100.

The status of the CI522 is given by the DIAG_I terminal in the Advant Fieldbus 100 bus DB element. The following status information is given on the DIAG_I terminal:

OK	CI522 is operating.
IE	Missing or faulty CI522.
PE	Process error, for example cable break.
ME	CI522 internal error, replace CI522.
SE	System error, for example several stations are time master or the bus length is invalid.
DC	Diagnostics has changed.
PSV	The CI522 is passive.
DPL	The CI522 only has default parameters.
I9 - I15	Not yet defined.

Changing bus length on CI522

If the bus length should be changed on a bus it is important to follow the procedure below:

1. Make sure the IMPL terminal is set to zero on **all** communication interfaces configured as master (that is MASTER=1) on the bus.
2. Change the bus length terminal on the DB-element for all communication interfaces that should act as master on the bus with the new bus length.
3. Set back the IMPL terminal to 1 on all communication interfaces.



It is not allowed to change the bus length without stopping the bus.

Communication Interface CI626/CI627/CI630/CI631

Defining the Communication Interface CI626/CI627

The CI626 and CI627 communication interfaces are used in Advant Controller 110 and Advant Controller 160. The DB element for communication interface CI626 is shown in [Figure 39](#).

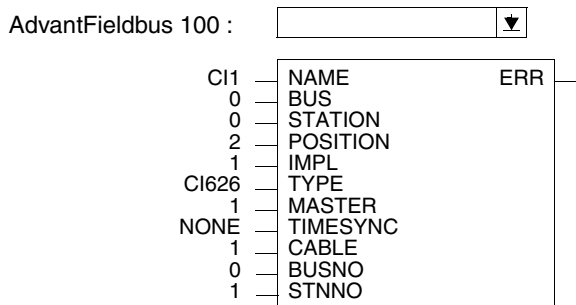

Figure 39. DB Element for CI626

When the communication interface has been defined, the IMPL terminal must be turned on to effectuate the configuration.

Defining the Communication Interface CI630/CI631

The CI630/CI631 communication interface is used in Advant Controller 160. The DB element for communication interface CI630 is shown in [Figure 40](#).

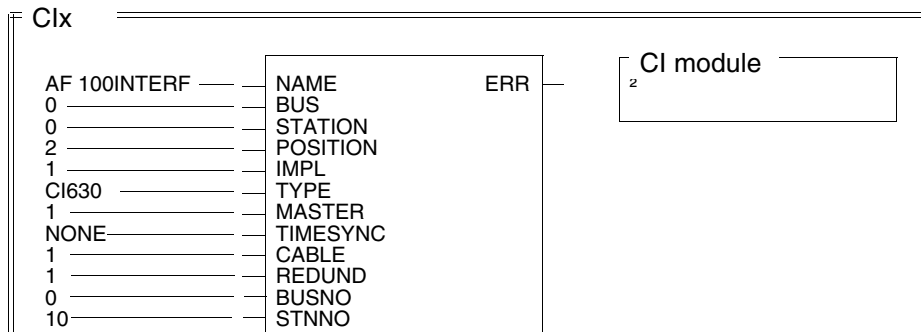

Figure 40. DB Element for CI630

When the communication interface has been defined, the IMPL terminal must be turned on to effectuate the configuration.

Setting the CI626/CI627/CI630/CI631 Operational

When the communication interface CI626/CI627/CI630/CI631 is started and configured, it must be set operational in order to enable communication on the Advant Fieldbus 100, and to participate in the sharing of the bus master responsibilities. This is done automatically by the Advant Controller 110 and Advant Controller 160.

If the CI626/CI627/CI630/CI631 is the first communication interface, on Advant Fieldbus 100, to become operational, it immediately assumes the bus master responsibilities. This is indicated on the front panel by turning on the “MASTER” LED and the “CONFIG OK” LED, both yellow.

If the communication interface detects the presence of a bus master on AF 100, it tries to get synchronized. When synchronized and if its internal configuration matches that of the bus master, it turns on the “CONFIG OK” LED.

If the communication interface is commanded operational on a bus where other communication interfaces already share the bus master responsibilities, the communication interface sends a message to the current master to notify its presence. The current bus master then sends the scan table to the communication interface while carrying out the bus master responsibilities. When the scan table is received the “CONFIG OK” LED is turned on. The communication interface adds its own CDPs to the scan table and then asks to become current bus master. After receiving the bus mastership the new updated scan table is distributed to all other bus administrators.

If a communication interface gets its configuration changed on-line due to changes in the database it updates its own scan table and then asks to become bus master. When bus master the scan table is distributed to all other bus administrators.

Removing a CI626/CI627/CI630/CI631

If the communication interface is to be permanently removed, all configured DSPs must be deleted in all stations on the bus having DSPs configured to or from the affected communication interface. If the DSPs are not deleted, the corresponding CDPs will be kept in the scan tables and thereby occupying valuable bandwidth. As a sending CDP must be deleted from the station by which it is configured, the CDP signal address can not be used by any other station unless the whole bus is restarted. This might also generate errors indicating missed CDP transmission.

When the DSPs have been deleted, the communication interface CI626/CI627/CI630/CI631 can be removed. If the transmission between the other still remaining communication interfaces shall not be disturbed it is important to make sure that the communication interface is never removed while the LED “MASTER” is on. This can be achieved by switching off the power of the affected station or removing the bus cable immediately after the LED “MASTER” goes off (which means that the responsibility for the bus master function has been passed over to the next communication interface). The remaining communication interfaces will automatically continue to share the bus master responsibilities between them and ignore the removed station.

CI626/CI627/CI630/CI631 Status Information

Status information about the communication interface CI626/CI627/CI630/CI631 is available during download of application to the Advant Controller 100 Series CPU,

by reading the error buffer of CPU or via module diagnostics. The latter one is described in documentation of corresponding diagnosis tool.

Error that occur during configuration of the communication interface by Advant Controller 100 Series CPU and those that occur during normal operation are inserted into CPU’s error buffer. The following list contains a summary of those errors.

For further information, see also [In Operation with Error Indications](#) on page 212.

Table 7. Status Information

Error messages	Reason	Action
Not enough memory on PM6xx	The CPU has not enough memory for configuration or background diagnosis of CI626/CI627/CI630/CI631	Reduce memory required by application
I/O module has wrong type	The DB element for the position is not a CI626/CI627/CI630/CI631 or there is another module than CI626/CI627/CI630/CI631 inserted at the appointed position.	Configure a DB element of the correct type or insert a CI626/CI627/CI630/CI631 at the position.
Read module parameter failed	Beginning (re-)configuration of CI626/CI627/CI630/ CI631 failed. This error mostly occurs if the module does not respond.	Check hardware configuration of CI626/CI627/CI630/CI631. Exchange module.
Write signal parameter failed	Writing of CDP configuration data to CI626/CI627 failed. Configuration data is invalid.	Change configuration data
Write state control failed.	Changing state (active, passive, delete) of CDPs was not possible due to wrong configuration.	Check configuration data of CDPs defined on Advant Fieldbus 100.
Read address list failed	This error may occur during configuration when reading dynamic memory addresses for CDPs of CI626/CI627/CI630/CI631.	The background diagnosis tries reading of addresses again some seconds later. The error should then be removable from error buffer

Table 7. Status Information (Continued)

Error messages	Reason	Action
Illegal station address	The station address defined in Advant Station 100 Series Engineering Station differs from that adjusted at thumbwheel switch in base station	Use same station addresses in Advant Station 100 Series Engineering Station and at thumbwheel switch
Process error detected	Background diagnosis has found a process error on CI626/CI627/CI630/CI631 module or on DSPs.	For detailed information use diagnosis tool.
Module error detected	Background diagnosis has found a device error on CI626/CI627/CI630/CI631 module.	Check hardware configuration of CI626/CI627/CI630/CI631. Exchange module. Note! The module error could be due to that the stations is connected to a bus running on a length different than 2000m.
System error detected	Background diagnosis has found a system error on CI626/CI627/CI630/CI631 module or on DSPs.	For detailed information use diagnosis tool.

Communication Interface PM810

Defining the Communication Interface for PM810

The Advant Fieldbus 100 communication interface is part of the PM810 processor module used in the Advant Controller 70. It is configurable in the AF 100 part of the PM810 DB element as shown in [Figure 41](#).

NOTE

The Advant Controller 70 do **not** have the capability of becoming bus master.

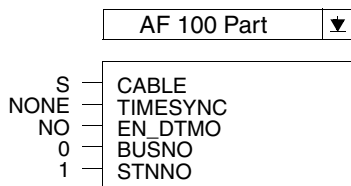

Figure 41. DB Element for PM810

Setting the Advant Fieldbus 100 Interface in PM810 Operational

When the PM810 is started and configured, the communication interface is automatically activated.

If the CDP configuration for the Advant Fieldbus 100 interface get updated due to adding, changing or deleting a DSP, the current bus master is notified and will update the scan table.

All other bus administrators will then receive the updated scan table from the current bus master.

Removing a PM810

If an Advant Controller 70 station is to be permanently removed from Advant Fieldbus 100, all configured DSPs must be deleted in all stations on the bus having DSPs configured to or from the affected station. If the DSPs are not deleted, the corresponding CDPs will be kept in the scan tables and thereby occupying valuable bandwidth. As a sending CDP must be deleted from the station by which it is configured, the CDP signal address can not be used by any other station unless the whole bus is restarted. This might also generate errors indicating missed CDP transmission.

Advant Fieldbus 100 Interface Status Information in PM810

Status information about the Advant Fieldbus 100 communication interface in PM810 is available, even during download of application to the Advant Controller

70 CPU, by reading the error buffer of the CPU or via module diagnostics. The latter one is described in documentation of corresponding diagnosis tool.

Error that occur during configuration of the PM810 and those that occur during normal operation are inserted into CPU's error buffer. The following list contains a summary of those errors. For further information see also [In Operation with Error Indications](#) on page 214.

Table 8. Status Information from PM810

Error messages	Reason	Action
Not enough memory on PM810	The CPU has not enough memory for configuration or background diagnosis of PM810	Reduce memory required by application
Illegal station address	The station address defined in Advant Station 100 Series Engineering Station differs from that adjusted at rotary switches on PM810	Use same station addresses in Advant Station 100 Series Engineering Station and at rotary switches
DSP with errors detected	Background diagnosis has found erroneous DSPs.	For detailed information perform module/channel diagnosis by means of diagnosis tool.
Error during BAP access	Background diagnosis has found an error when accessing Advant Fieldbus 100 communication interface (BAP) on PM810	For detailed information perform module/channel diagnosis by means of diagnosis tool.

Communication Interface CI810

Defining the Communication Interface CI810

The CI810 communication interface is defined in an Advant Controller 110/410/450 and is used to control the S800 I/O station. The CI810 is connected to the Advant

Controller via Advant Fieldbus 100. The DB element for the CI810 communication interface is shown in [Figure 42](#).

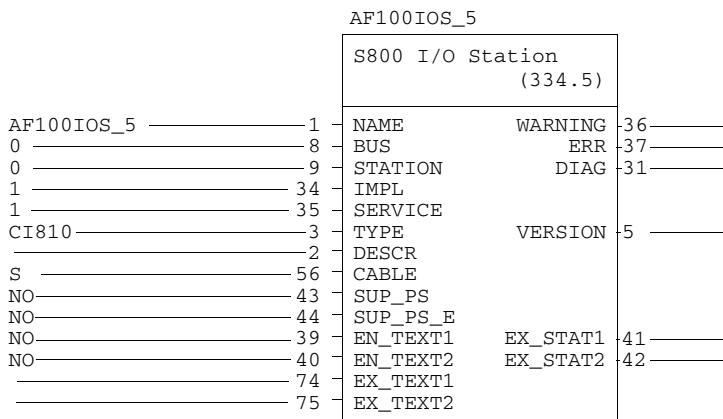

Figure 42. DB Element for CI810

Setting the CI810 Operational

The Advant Controller configures and sets the CI810 to operational automatically when the S800 I/O is configured in the database. The own station communication interface must however first has been set to operational by the Advant Controller.

For setting up and configuring the S800 I/O station refer to *S800 I/O User's Guide*.

Removing a CI810

When the CI810 and the S800 I/O system is to be permanently removed, all configured CDP's must be deleted. This is done by either resetting the IMPL flag or performing a DDB command to the S800 I/O station DB element. Replacing the communication interface with another CI810 communication interface, see [In Operation with Error Indications](#) on page 217.

To remove the S800 I/O station, perform the following steps:

- Reset the IMPL terminal or perform a DDB command on the CI810 data base element.
- Remove the Advant Fieldbus 100 from the CI810.

CI810 Status Information

The status information of the communication interface, CI810, is available with the DB element S800 I/O Station.

The status of the CI810 is given by the DIAG terminal in the S800 I/O Station DB element.

The following status information is given on the DIAG terminal:

ACT	CI810 is operating.
IDF	Identity failure.
SE	Severe Error: Severe errors in the station.
HWE	Station Hardware Error. An error in CI810 Hardware.
SWE	Station Software Error. Restart of the CI810 should probably clear the error.
PHE	Peripheral Hardware error. Hardware error or missing hardware.
PRE	Process Errors. 'Soft' error condition, for example, I/O channel out of range.
CRA	Cable Redundancy Available. Indicates that the CI810 is configured to have redundant bus cables.
SNA	Station Not Available
RC1	Redundant cable 1 Failed. Indicates that the communication over the cable #1 of the redundant cable pair does not work.
RC2	Redundant cable 2 Failed. Indicates that the communication over the cable #2 of the redundant cable pair does not work.
CD	Change Diagnostics.
RPA	Redundant Power A failure.

- RPB** Redundant Power B failure.
- GE** General (unspecified) error.
- GW** General (unspecified) warning.

The SE, SNA, IDE, SWE, and GE gives error on the S800 I/O station DB element, inactive ACT (NOT ACT) and the rest except CD and CRA gives warning.

Communication Interface CI869

Defining the Communication Interface CI869

The CI869 communication interface is used with AC 800M controller.

The CI869 cannot function as bus master on the AF 100 bus (the Master LED on the CI869 unit is not used).

Before the CI869 can be configured in the hardware tree in Control Builder, the CI869AF100HWLib must be connected to the controller.

The CI869 unit can be added at position 1 to 12 under the AC 800M controller in the hardware tree.

Figure 43 shows an example of the hardware tree with the CI869 hardware unit at position 1 under the AC 800M controller.

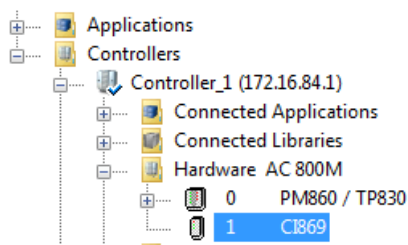

Figure 43. CI869 in Control Builder

Right click the CI869 unit to open the Editor and update the parameters. See [Figure 44](#).

Parameter	Value	Type	Unit	Min	Max
Bus identity		string			8
Station Number	1	dint		1	80
Time sync	AF100 Slave	enum			
Cable	Single	enum			
Double DSP Timeout	false	bool			

Figure 44. Parameters for CI869

The CI869 cannot function as bus master on the AF 100 bus (the Master LED on the CI869 unit is not used).

Setting the CI869 Operational

CI869 is automatically set operational by the AC 800M when the controller configuration is downloaded to the controller.

Removing the CI869

If a CI869 is to be permanently removed, all the configured DSPs that communicates with the affected CI869 must be deleted in all stations on the AF 100 bus.

To remove CI869:

1. Delete at least all the *DSP Send* units under the CI869 in the hardware tree.
2. Download the project to the controller.
3. Go to Offline mode.

4. Remove the CI869 hardware unit from the hardware tree.
5. Download the project to the controller.
6. When the R(un) LED of the CI869 goes off, remove the CI869 from the controller.

CI869 Status Information

The status information for CI869 is available as Unit Status in Control Builder. See [Table 50](#) for details.

DataSet Peripheral Communication

For transmission of data between different nodes DataSet Peripheral (DSP) is used. The maximum number of configured DSPs is different for each type of controller:

- Advant Controller 400 Series can handle about 4000 DSPs
- AC 800M controller can handle 4000 DSPs
- Advant Controller 110 can handle 200 DSPs
- Advant Controller 160 can handle 400 DSPs
- Advant Controller 70 can handle 50 DSPs.

The Advant Fieldbus 100 can handle about 4000 CDP's. Each DSP uses one CDP and 50 CDP's are reserved for each S800 I/O station configured on the bus. This means that the actual maximum number of DSPs is reduced with 50 per configured S800 I/O station.

The implementations of DSP in the Advant Controller 70/110/160 and the Advant Controller 400 Series differ slightly. This chapter describes these differences.

The DSP communication is managed by the DSP data base elements. Each DSP element can reference to up to eight DAT elements of the types boolean, integer, integer long and real.

On the DSP data base element the number of DATs, the transmission interval, the

direction of data, the identity and the station number of the sending DSP are parameters set by the users.

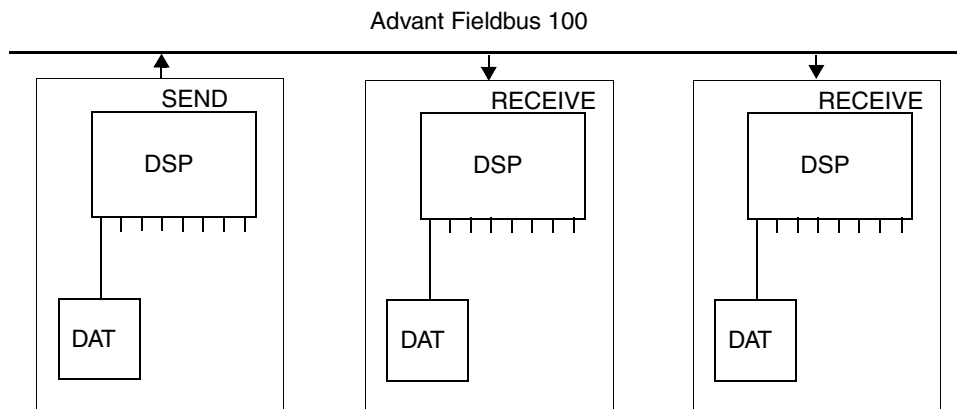

Figure 45. DataSet Peripheral and DAT Elements

The principles of sending data are: The DSP's DATs are updated, for example from PC program. The DSP data base is scanned and the data of the referenced DATs is written to the CDP. The data is then sent on the bus. Receiving data is performed the other way around.

IDENT and STATION forms the signal identity which is the identifier of the DataSet Peripheral on the Advant Fieldbus 100. The signal identity must be equal on the sending and receiving DSPs. A signal identity must be unique for one DSP on one bus within one Advant Controller. On a bus a signal identity can be used by **one** sending only, and by several receiving DSPs.

This gives the possibility to send data from one node and listen to it at several nodes, that is DataSet Peripherals are broadcasted on the bus.

The VALID flag is initially cleared and is set when data is sent or received. For receiving DSPs the VALID terminal specifies whether the current data of the DSP is valid or not. The VALID flag is cleared when no data has been received within the last four cycles (CYCLETIM) or when update data from the communication interface has failed. For sending DSPs the VALID terminal is set when the data has been written to the communication interface. VALID is cleared in case update to the communication interface has failed.

The ERR terminal specifies whether the DSP is in error state or not, typically caused by communication error between the DSP task and the communication interface or error in configuration of the CDP on the communication interface.

As the DAT elements merely represent the interpretation of the data in the DSP and not the communication aspects, they will not be discussed further in this manual.

An other function for transmission of data, DataSet (DS), exists. DS can only be used for communication between Advant Controller 110 stations. DS is quite similar DSP.

Defining DataSet Peripherals in the Advant Controller 400 Series

When defining DSPs, the associated data base element is automatically given a unique name. The name can be changed by the user, and the associated DAT elements are automatically defined.

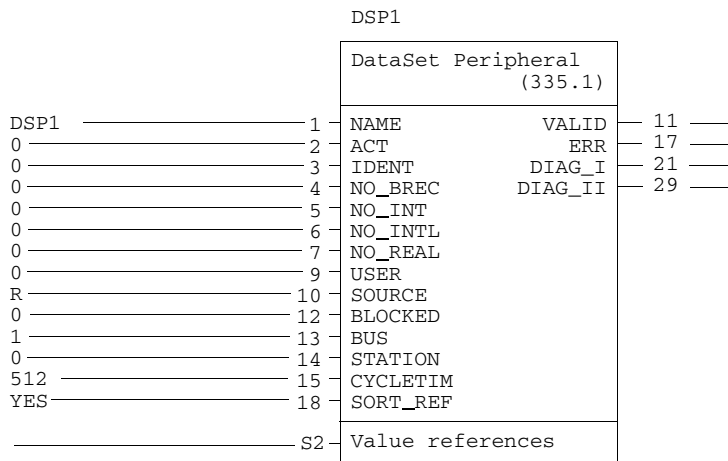

Figure 46. DataSet Peripheral Element in AC 400 Series

The terminal CYCLETIM controls the transmission interval of a DSP (that is how often the CDP is transmitted on the Advant Fieldbus 100). The CYCLETIM range, in Advant Controller 400 Series, is 32, 64, 128, 256, 512, 1024, 2048 and 4096 ms.

When Fast-DSP PC-elements are used, the CYCLETIM range is 1, 2, 4, 8, 16, 32, 64, 128, 256, 512, 1024, 2048 and 4096 ms. 1ms is only available when using 2000m bus length. For further info, please see the PC-element manual.

In the Advant Controller 400 Series the actual cycle time used is determined by the CYCLETIM value and the DSP task basic cycle time. CYCLETIM shall be bigger than or equal to the basic cycle time.

The DSP task basic cycle time is the basic scan time of the task, the default value is 512 ms.

The basic cycle time can be changed with the APP command as the very first thing at the configuration of the system.



If CYCLETIM is less than the basic cycle time, the CDP of the DataSet Peripheral is transmitted on the bus with the time defined on the CYCLETIM terminal, but the DSP is scanned with the basic cycle time value. This implies that updates to/from the bus are not performed as often as specified on the CYCLETIM terminal.

For receiving DSPs the CYCLETIM value is used for the receive data time out supervision and it is strongly recommended to use the same cycle time for sending and receiving DSPs.



The DSP STATION number must differ from the station numbers used on CI810 (S800 I/O Station) on the same bus.

Defining DataSet Peripherals in the Advant Controller 70/110/160

When defining DSPs, the associated data base element is automatically given a unique name, which can be changed by the user, and the associated DAT elements are automatically defined.

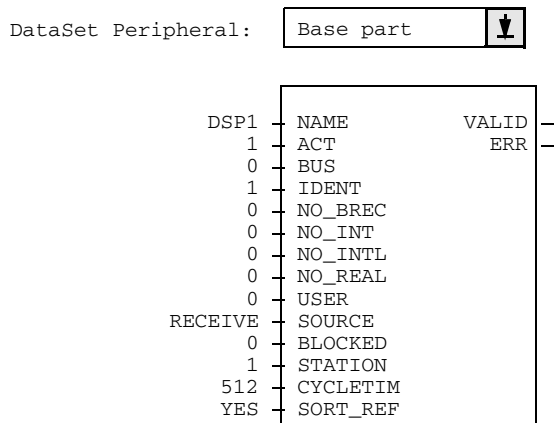

Figure 47. DataSet Peripheral Element in AC 70/110

The terminal CYCLETIM controls the transmission interval of a DSP (that is how often the process data value is transmitted on the Advant Fieldbus 100).

The CYCLETIM range, in

Advant Controller 70/110, is 1, 2, 4, 8, 16, 32, 64, 128, 256, 512, 1024, 2048 and 4096 ms.

Values to/from DSP are read/written by the PC-program. The cycle time of PC-program and the transmission interval DSP is not synchronous.

For receiving DSPs the CYCLETIM value is used for the receive data time out supervision and it is strongly recommended to use the same cycle time for sending and receiving DSPs.



The DSP STATION number must differ from the station numbers on the CI810 (S800 I/O Station) on the same bus.

Defining DataSet Peripherals in AC 800M

The configuration of the CI869 hardware unit in the hardware tree in Control Builder defines the AF 100 bus with AC 800M controller.

The following hardware units under CI869 are used to configure AF 100:

- AF 100 Station with DSPs
- DSP Group
- My DSP Group
- My AF 100 Station Status
- AF 100 Station

The hardware units *AF 100 Station with DSPs*, *DSP Group*, and *My DSP Group*, holds the DSPs.

For information about *AF 100 Station* and *My AF 100 Station Status*, see [Station supervision in AC 800M](#) on page 154.

AF 100 Station with DSPs

The *AF 100 Station with DSPs* is an organization unit for up to 50 *DSP Receive* subunits. For each *AF 100 Station with DSPs*, a Station Status CDP is configured on the CI869 for supervision of a remote station on the bus. Its content is presented as *Extended Status* in the hardware editor of *AF 100 Station with DSPs*.

The *AF 100 Station with DSPs* can be placed at position 1...80, and it can have receiving DSPs below it.

The *AF 100 Station with DSPs* represents an AF 100 station on the bus with the station number equal to the position number in the hardware tree. It organizes the DSPs that are received from that station where the Major DSP ID number is equal to the station's Station number.

The position numbers for the *AF 100 Stations with DSPs* represent both the station number for these stations and the Major DSP IDs.

DSP Group

DSP Group is a hardware unit for organizing up to 50 DSP subunits (both receiving and sending), with the same Major DSP ID.

DSP Group is similar to the *AF 100 Station with DSPs*, but *DSP Group* does not cause CI869 to configure any Station Status CDP.

The position number [1...80] gives the Major DSP ID for the DSP hardware units below *DSP Group*.

The *DSP Group* is used to organize DSPs with the same Major ID. It shall be used if the Major ID of the DSPs is not the same as the Station number of the sending station. When *DSP Group* is used, the *AF 100 Station* hardware unit can be used to retrieve the station status CDP for the AF 100 Stations on the bus.

My DSP Group

My DSP Group is a hardware unit for organizing up to 50 Sending DSP subunits, with the same Major DSP ID, sent from this station (also referred to as My Station).

The receiving DSP subunits should not be added under *My DSP Group*.

DSP Send and DSP Receive

The two hardware units - DSP Send and DSP Receive - represent the DSPs that the CI869 sends and receives respectively.

The Minor DSP ID together with the Major DSP ID gives the DSP ID.

The Major DSP ID, which is determined by the position number of the hardware unit above the DSP, can be from 1 to 80.

The position number of the DSP [1...50] gives the Minor DSP ID. The ID can be modified by changing the position of the DSP (moving it up or down in the HW tree).

The DSPs are categorized as either DSP Send (the source communication unit) or as DSP Receive (the sink communication unit), and have a defined cycle time.

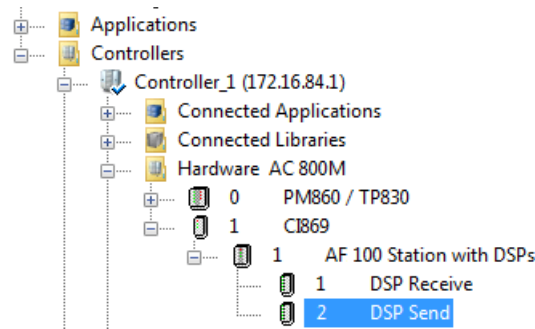

Figure 48. DSP Receive and DSP Send units

The cycle time is used at the source to define the sending period, and at the sink to define the time-out. For DSP Receive, the time-out occurs if no slave frame is received within four cycles, or within eight cycles (if Double DSP Timeout is configured for CI869 unit).



If the DSPs in the CI869 hardware tree give a bus load greater than 80%, an error is displayed during download of the hardware configuration to the controller, and the download is aborted.

If the DSPs in the CI869 hardware tree give a bus load greater than 70%, a warning is displayed during download of the hardware configuration to the controller.



The load calculation in Control Builder is based only on the DSPs from individual CI869 unit. The complete DSP configuration is compiled by the Bus Master, and it is no guarantee that the configuration downloaded to the AC 800M can be used on the bus.

32 Bytes Data Consistency

The 32 byte consistency can be achieved by setting the parameter *32 Bytes Data Consistency*, which is available for *DSP Send* and *DSP Receive*.

If the *32 Bytes Data Consistency* is enabled (true), the Consistency channel in the *DSP Send* or *DSP Receive* hardware editor must be connected to a variable which is written after each reading/writing of the DSP.

The Consistency channel is an output channel. It must be used as follows:

- Connect the Consistency channel to a boolean variable.
- For a *DSP Receive*, a value must be assigned to the connected variable (the value does not matter, that is, it can be set true or false) in the same program that reads the DAT-channels of the DSP. The assignment must be done at each execution cycle.
- For a *DSP Send*, the value of the connected variable must be assigned in a program that is executed by a different 1131 task (for example, *TaskA*) compared to the task that executes the program that writes to the DAT-channels of the DSP (for example, *TaskB*). The assignment must be done at each execution cycle. *TaskA* must have the same interval time as *TaskB*, but a higher execution offset than *TaskB*. This ensures that the variable is written after the DAT values.

If the *32 Bytes Data Consistency* is enabled, but the Consistency channel is not written, no data will be transferred at all for this DSP. This gives an error at download.

If 32 Bytes Data Consistency parameter is not enabled (false), 4 bytes data consistency is guaranteed.

Configuring DataSet Peripherals

At start up of the system, the DSP data base definition is configured on the communication interface. For each DSP, a corresponding CDP is configured. The receiving DSPs are immediately operational and able to receive data from the Advant Fieldbus 100. For sending DSPs, all the connected communication interface must be informed about the change in the configuration in order to regenerate their scan tables.

At configuration, a scan table is built up containing the sending CDPs, configured on the associated communication interface and the current scan table working on the bus, if any.

When the configuration is performed, the new scan table is transferred to all Bus Administrator communication interfaces on the bus. By this, all communication interfaces, defined as masters, have knowledge of all configured sending CDPs on the bus.

Each CDP in the scan table is owned by the station number of the communication interface on which it was configured. Any reconsideration of the CDP such as size, signal identity, delete etc. is to be done by the owner communication interface unless the station number is changed. A consequence of this is that a change of the communication interface station number might result in CDPs not owned by any communication interface, orphan CDPs. Orphan CDPs is a source of failed configuration that can be tricky to handle. Before change of station number or removal of a station from the bus, all CDPs configured on the current communication interface should be deleted. The most definite way to delete orphan CDPs is to reset the current scan table, that is to reset the IMPL terminal on each communication interface on the bus defined as busmaster. This must be done simultaneously on all the mentioned communication interfaces. The bus is by this stopped. The scan table is then built up from the beginning when the IMPL terminals are set again.

In the Advant Controller 400 Series up to about 4000 DSPs can be configured on one bus.

The configuration routines are heavy to execute, especially in combination with bus mastership. Configuring DSPs in the Advant Controller 400 Series takes about seven seconds per 100 DSPs if several Bus Administrators are used. In case of just one Bus Administrator, the configuration time is about the double.

When a DSP is to be configured, there must be room for it in the communication interface scan table. In case the scan table can not house the CDP configuration overload has occurred, the CDP is not configured and by this not transferred on the bus. Further configurations of the communication interface will also fail due to configuration overload. For calculation of the configuration load, see DataSet Peripheral Transfer Time.

In the Advant Controller 400 Series, a DSP's DIAG terminal will show SNC (Signal Not Configured) for a configuration overload.

Configuration Example

As a configuration example, consider a network with two Advant Controller nodes with station address 15 and 21. The user can then define two DataSet Peripheral elements as shown in [Figure 49](#).

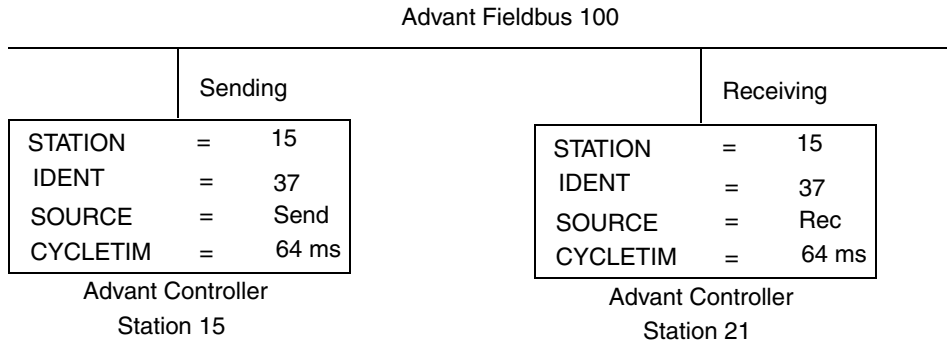

Figure 49. Configuration Example

The sending DSP is defined in station 15. Data from this element is transmitted on the AF 100 every 64 millisecond. In station 21, the receiving DSP receives data from station 15 (every 64 millisecond).

The DSP VALID flag is set in station 15 at the first update of the bus (send), and in station 21 when read from the bus (receive).

Event Set on Advant Fieldbus 100

For sending time tagged process events from an Advant Controller 110 or an Advant Controller 70 to an Advant Controller 400 Series, EventSet is used. EventSet (EVS) element groups a set of event channels for sending and receiving events. EVS elements must be configured in both

Advant Controller 400 Series (receive) and in Advant Controller 70/110 (send).

Each Advant Controller 400 Series can handle up to 511 EVS(R) elements and each Advant Controller 70/110 can handle up to 16 EVS(S) elements.

The process events are time tagged with the local time at the event source when an event occurs. In order to get the date correctly set, the event must be available to the

Event set handler in Advant Controller 400 Series within 22 hours.

The Advant Fieldbus 100 time synchronization master must send time synchronization messages periodically in order to have a synchronized time for all events. The time tag accuracy within and between Advant Fieldbus 100 busses, under one Advant Controller 400 station, is two milliseconds. When calculated I/O is used,

that is AIC and DIC, the accuracy also depends on the cycle time of the calculated I/O and the control module cycle time under which the calculated I/O is updated.

On Advant Fieldbus 100, the EventSet communication is managed by the EVS(S) and EVS(R) elements. Each EVS(S) element can reference to up to 32 AIC, DIC channel elements and DIS65x elements and each EVS(R) can reference to up to 32 AIEV and DIEV channel elements.

The EVS(R) element shall reference to the opposite EVS(S) element, this is done by specifying the station and the identity of the EVS(S) element.

Event Transfer

General Features

Time-tagged events from an Advant Controller 110 are transferred to one or several event receivers over Advant Fieldbus 100.

An event receiver can be:

- An Advant Controller 100 Series
- An Advant Controller 400 Series.
- A personal computer running AC 100 OPC Server.



The number of event receivers may be up to 10 for Advant Fieldbus 100.

A possible network configuration for event transfer including Advant Controller 70 is shown in Figure 51.

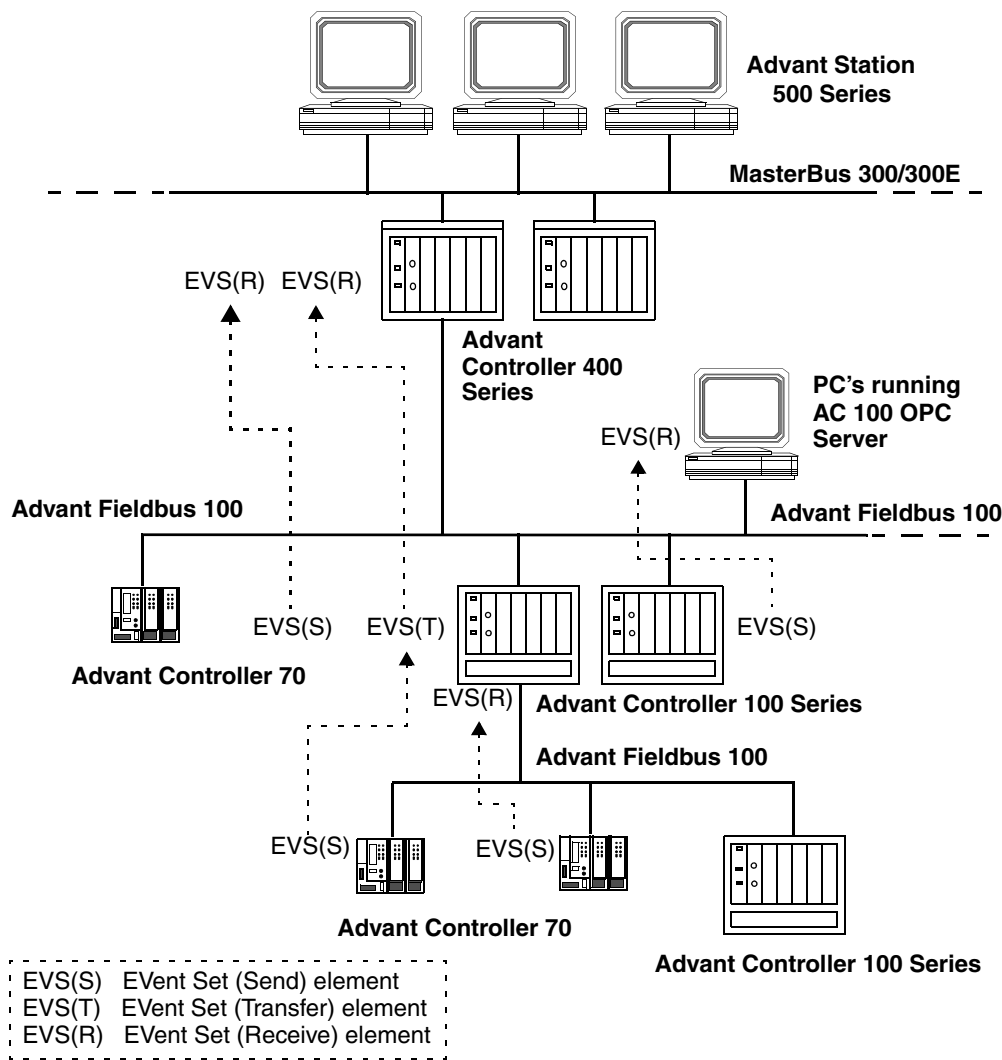

Figure 51. Configuration Alternatives for Event Transfer

The transfer of time-tagged events over Advant Fieldbus 100 is configured by Event Set (EVS) elements.

An Event Set element of type “send” (configured by data base element EVS(S)) groups a set of Event Channels for transmission of events. Each Event Set can handle up to 32 Event Channels of different types which can be mixed in arbitrary order.

An EVS(S) element collects events from its referenced Event Channel elements and sends the events to the event receivers when those requests them.

An Event Set of type “transit” (configured by data base EVS(T)) is used in Advant Controller 100 Series for transiting (receiving and sending) events from an EVS(S) element located on AF 100 Station.

The Advant Controller 100 Series then acts as a transit station. The EVS(T) element shall refer to the opposite sending EVS(S) element. This is configured by specifying the identity of the EVS(S).

One Advant Controller 100 Series can handle up to 16 Event Set elements EVS(S) or EVS(T). For DB elements EVS(S) the Event Channel elements are considered as event sources. For DB elements EVS(T) the referenced DB element EVS(S) is considered as event source.

Event Transfer to AC 100 OPC Server and AdvaSoft for Windows

The event transfer to personal computers running AC 100 OPC Server and AdvaSoft for Windows is described in *Advant OPC Server for Advant Fieldbus 100 User's Guide (3BSE013896*)* and *Advant Fieldbus 100 Interface - AdvaSoft for Windows User's Guide (3BSE006238*)*.

Creating EventSets in Advant Controller 400 Series

Creating Event Channel elements AIEV and DIEV

Before creating an EventSet data base element the event channel data base elements, to be referenced, have to be created. One data base element per channel is created, AIEV for analog channels and DIEV for digital.

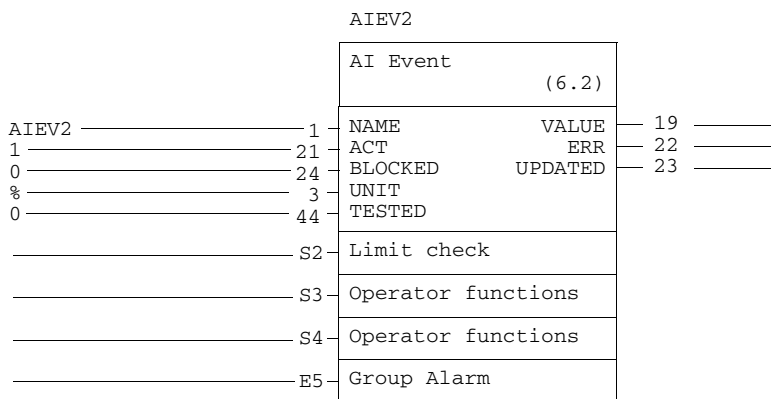

Figure 52. Base Part of Data Base Element AIEV in Advant Controller 400 Series

The DIEV appearance is similar and is not further described in this document.



The AIEV and DIEV elements look like the AIC respective DIC elements. There is however one main difference, the VALUE, ERR and UPDATED terminals is NOT updated by the EventSet handler. The VALUE, ERR and other related terminals are included to make it possible to transfer the dynamic process value separately, that is by using the DataSet Peripheral (DSP) communication.

Creating the EventSet element EVS(R)

When the channel elements to be referenced are created, the EVS(R) data base elements can be created. For each receiving element a corresponding EVS(S) element must be created in the sending end, that is in an Advant Controller 110. The EVS(S) and EVS(R) must be equally defined in sense of corresponding channel

elements. S2 and S3 (Even references) terminals contains REF1 - 16 respective.

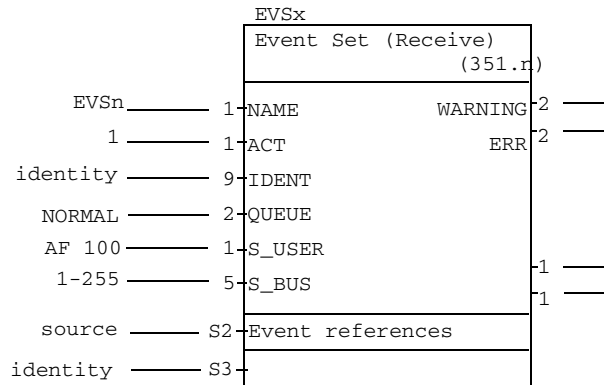

Figure 53. Event Set EVS(R) for reception of Time tagged process events

REF17 - 32 which are the reference to the channel DB-element. The AIEV and DIEV elements can be given arbitrary names.

Creating EventSets in Advant Controller 70/110/160

Creating Event Channel elements AIC and DIC

Before creating an EventSet data base element the event channel data base elements, to be referenced, have to be created. One data base element per channel is created:

- AIC for analog channels
- DIC for digital.

in Advant Controller 70/110/160 and DI650S for signals from DI650 in Advant Controller 100 Series.

AI Calculated: 

AIC1	NAME	VALUE
1	ACT	ERR
0	NORM_TR	
0	AL_DIAL	
640ms	SCANT	

Figure 53-1. Base Part of Data Base Element AIC in Advant Controller 70/110/160

The DIC appearance is similar and is not further described in this document.

Creating the EventSet element EVS(S)

When the channel element to be referenced are created the EVS(S) data base elements are created. For each sending element a corresponding EVS(R) element must be created in the receiving end, that is in an Advant Controller 400 Series. The EVS(S) and EVS(R) must be equally defined in sense of corresponding channel elements. In Advant Controller 100 Series, it is not allowed to reference to DI650S signals of the same DI650 device from different EVS(S) elements.

Event Set (Send): 

EVS1	NAME	CLEAR_Q
1	ACT	Q_EMPTY
1	IDENT	WARNING
NORMAL	QUEUE	ERR
		ERRTYPE

Figure 54. Event Set EVS(S) for Sending of Time tagged Process Events in AC70/110

S2 and S3 (Even references) terminals contains REF1 - 16 rest. REF17 - 32 which are the reference to the channel DB-element. The AIC and DIC elements can be given arbitrary names.

Time Synchronization on Advant Fieldbus 100

Time synchronization messages are sent over Advant Fieldbus 100 to synchronize the real time clocks in the different stations. One station is user defined as Time Synchronization MASTER. The other AF 100 Stations are to be user defined as SLAVE's (or NONE - see next paragraph). The definitions are to be set in the Communication Interface units DataBase element, for example CI522, CI526, CI626, CI810, CI869, and PM810. For further info, please see the DB-element manual for the appropriate AF 100 Station.

Stations that do not need to get time synchronized are defined as time synchronization NONE. The timesync is sent from the time synchronization master to the time synchronization slaves every 1024 ms.

The time synchronization accuracy between stations on Advant Fieldbus 100 is < 2 ms. This means for example that the accuracy of a time stamp made with DI651 is <2 ms.

The time sync accuracy is distributed in the systems as described in [Figure 55](#).

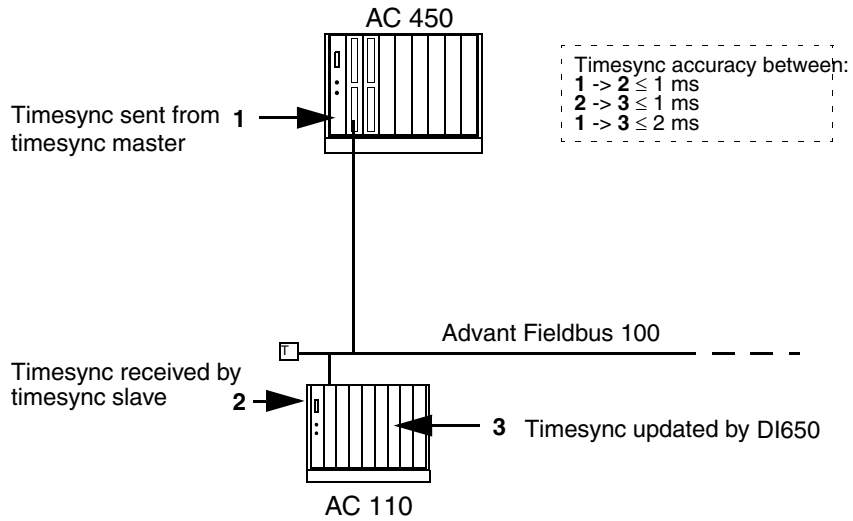

Figure 55. Distribution of Time Synchronization accuracy

Message Transfer

Message transfer on the Advant Fieldbus 100 is used for EventSet, diagnostics, and for loading PC programs to remote Advant Controller 70, 110 or 160 stations.

The communication layers in the communication interfaces and the Advant Controller provide a transparent means of communication.

Performance and Bus Load

The Advant Fieldbus 100 runs at a data rate of 1.5 MBits/second. Some of the information is, however, used for preambles and protocol overhead, so the net data rate will be somewhat less.

Bus Load Calculation on 2000 meters

The Busload in percent is calculated according the following formula:

$$\text{Busload} = \text{AF 100 Station}(\text{load}) + \text{CI810/CI820}(\text{load}) + \text{S800 module}(\text{load}) + \text{DSP}(\text{load})$$

Table 9. Bus Load Calculation on 2000 meters

Bus Load Calculation			
AF 100 Station	Each station, that is AC 400 Series, AC 110, AC 160, AC 70, CI810, and so on, sends a 4 byte message with cycle time 1024 ms. Generated bus load 0.009%		
CI810/CI820	Each CI810 and each CI820 pair sends a 32 byte message with the following cycle times:		
	Master	1024 ms. Generated bus load 0.025%	
	MOD 300	512 ms. Generated bus load 0.049%.	
S800 module	Input module	Each module generates a bus load according to Table 10	
	Output module	Master	Each module generates a bus load according to Table 11 .
		MOD 300	Each module generates a bus load according to VALUE CYCLE TIME + DQ CYCLE TIME. Each cycle time generates a bus load according to Table 12 .

Table 9. Bus Load Calculation on 2000 meters

Bus Load Calculation		
S800 module (continued)	Drives module	Each module generates a bus load according to Table 13 .
DSP	Each DSP generates a bus load according to Table 14 .	



[Table 10](#), [Table 11](#), and [Table 12](#) views only the bus load for the most common S800 I/O modules, for information about other modules see S800 User's Guide.

Table 10. Advant Fieldbus 100 Bus Load in percent for S800 Input Modules.

S800 I/O modules cycle time INSCANT/VALUE CYCLE TIME (ms)													
S800 module	1	2	4	8	16	32	64	128	256	512	1024	2048	4096
DI810/820	8.800	4.400	2.200	1.100	0.550	0.275	0.138	0.069	0.034	0.017	0.009	0.004	0.002
AI810/830/835	25.200	12.600	6.300	3.150	1.575	0.788	0.394	0.197	0.098	0.049	0.025	0.012	0.006
AI820	15.600	7.800	3.900	1.950	0.975	0.488	0.244	0.122	0.061	0.030	0.015	0.008	0.004

Table 11. Advant Fieldbus 100 Bus Load in percent for S800 Output Modules in Advant Controller 400 Series Master Version
(Advant Controller 410, Advant Controller 450).

S800 I/O modules cycle time OUTSCANT (ms)													
S800 module	1	2	4	8	16	32	64	128	256	512	1024	2048	4096
DO810/820	8.809	4.409	2.209	1.109	0.559	0.284	0.146	0.077	0.043	0.026	0.017	0.013	0.011
AO810	25.225	12.625	6.325	3.175	1.600	0.812	0.418	0.221	0.123	0.074	0.049	0.037	0.031
AO820	15.615	7.815	3.915	1.965	0.990	0.503	0.259	0.137	0.076	0.046	0.030	0.023	0.019

Table 12. Advant Fieldbus 100 Bus Load in percent for S800 Output Modules in Advant Controller 400 Series
MOD 300 Version (Advant Controller 460).

S800 I/O modules cycle time VALUE CYCLE TIME/DQ CYCLE TIME (ms)													
S800 module	1	2	4	8	16	32	64	128	256	512	1024	2048	4096
DO810/820	8.800	4.400	2.200	1.100	0.550	0.275	0.138	0.069	0.034	0.017	0.009	0.004	0.002
AO810	25.200	12.600	6.300	3.150	1.575	0.788	0.394	0.197	0.098	0.049	0.025	0.012	0.006
AO820	15.600	7.800	3.900	1.950	0.975	0.488	0.244	0.122	0.061	0.030	0.015	0.008	0.004

Table 13 displays the generated Advant Fieldbus 100 bus load in percent at different cycle times on CYCLETIM for DRIVE units.

Table 13. Advant Fieldbus 100 Bus Load in percent for DRIVES

Module cycle time IOSCONT1 & 2 in percent													
Drive Module	1	2	4	8	16	32	64	128	256	512	1024	2048	4096
DRISTD	31.200	15.600	7.800	3.900	1.950	0.975	0.488	0.244	0.122	0.061	0.030	0.015	0.011
DRIENG	-	25.200	12.600	6.300	3.150	1.575	0.788	0.394	0.197	0.098	0.049	0.025	0.012

The total load for an engineered drive is the sum of load for IOSCONT1 and IOSCONT2, see formula:

$$total\ load = (load\ generated\ by\ IOSCONT1) + (load\ generated\ by\ IOSCONT2)$$

The total load if IOSCONT1 is 128 ms and IOSCONT2 is 512 ms is:

$$total\ load = 0.394 + 0.098 = 0.492\%$$

Table 14 displays the generated Advant Fieldbus 100 bus load in percent at different cycle times on CYCLETIM for single DSPs.

Table 14. Advant Fieldbus 100 Bus Load in percent for DSPs

CYCLETIM for DSP (ms)													
DSP size	1	2	4	8	16	32	64	128	256	512	1024	2048	4096
1 DAT	8.800	4.400	2.200	1.100	0.550	0.275	0.138	0.069	0.034	0.017	0.009	0.004	0.002
2 DATs	10.800	5.400	2.700	1.350	0.675	0.338	0.169	0.084	0.042	0.021	0.011	0.005	0.003
3-4 DATs	15.600	7.800	3.900	1.950	0.975	0.488	0.244	0.122	0.061	0.030	0.015	0.008	0.004
5-8 DATs	25.200	12.600	6.300	3.150	1.575	0.788	0.394	0.197	0.098	0.049	0.025	0.012	0.006

Example of a calculation for an Advant Fieldbus 100 bus with following configuration:

Table 15. Calculation example Advant Fieldbus 100 (Master)

Advant Controller 450 station	1 x 0.009 =	0.009
2 DSP with 7 DAT, cycle time 128	2 x 0.197 =	0.394
3 DSP with 3 DAT, cycle time 256	3 x 0.061 =	0.183
5 DSP with 1 DAT, cycle time 64	5 x 0.138 =	0.690
S800 I/O station	1 x 0.009 + 1 x 0.025 =	0.034
3 DI 810 INSCANT 32	3 x 0.275 =	0.825
2 AI 810 INCANT 256	2 x 0.098 =	0.196
1 DO 810 OUTSCANT 64	1 x 0.146 =	0.146
1 AO 810 OUTSCANT 512	1 x 0.074 =	0.074
Advant Controller 70 station	1 x 0.009 =	0.009
1 DSP with 8 DAT, cycle time 128	1 x 0.197 =	0.197
5 DSP with 2 DAT, cycle time 256	5 x 0.042 =	0.210
	Σ bus load	2.967%

Table 16. Calculation example Advant Fieldbus 100 (MOD 300)

AC 460 station	1 x 0.009 =	0.009
S800 I/O station	1 x 0.009 + 1 x 0.049 =	0.058

Table 16. Calculation example Advant Fieldbus 100 (Continued)(MOD 300)

3 DI 810	VALUE CYCLE TIME 32	3 x 0.275 =	0.825
2 AI 810	VALUE CYCLE TIME 256,	2 x 0.098 =	0.196
1 DO 810	VALUE CYCLE TIME 64, DQ CYCLE TIME 512	1 x 0.146 + 1 x 0.017 =	0.163
1 AO 810	VALUE CYCLE TIME 512, DQ CYCLE TIME 512	1 x 0.049 + 1 x 0.049 =	0.098
Σ bus load			1.349%

The figures in Table 10 to Table 14 are calculated according to the formula below. The bus load depends on the CDP configuration and the configured stations and can be calculated by the following formula:

$$BusLoad = \sum \frac{Nbr \cdot Ttr}{cT} 100 \quad (<70\%)$$

Which gives the bus load in percent, where the sum is taken over all different sending DSPs and:

Nbr = number of CDPs (of the same size and cT),

Ttr = transfer time in ms (from Table 17)

cT = desired cycle time in ms (1, 2, 4, 8, 16...4096).

The transfer times for a CDP over Advant Fieldbus 100 depends of the size of the CDP (see Table 17).

Table 17. Cyclic Data Packet Transfer time

CDP size	DSP size	Transfer time (ms)
4 byte size	1 DAT element	0.088
8 byte size	2 DAT elements	0.108
12-16 byte size	3-4 DAT elements	0.156
20-32 byte size	5-8 DAT elements	0.252

Bus Load Calculation on 8500 meters

The Busload in percent is calculated according the following formula:

$$\text{Busload} = \text{AF 100 Station}(\text{load}) + \text{CI810/CI820}(\text{load}) + \text{S800 module}(\text{load}) + \text{DSP}(\text{load})$$

Table 18. Bus Load Calculation on 8500 meters

Bus Load Calculation			
AF 100 Station	Each station, that is AC 400 Series, AC 70, CI810, and so on, sends a 4 byte message with cycle time 1024 ms. Generated bus load 0.016%		
CI810/CI820	Each CI810 and each CI820 pair sends a 32 byte message with the following cycle times:		
	Master	1024 ms. Generated bus load 0.032%	
	MOD 300	512 ms. Generated bus load 0.065%.	
S800 module	Input module	Each module generates a bus load according to Table 19	
	Output module	Master	Each module generates a bus load according to Table 20 .
		MOD 300	Each module generates a bus load according to VALUE CYCLE TIME + DQ CYCLE TIME. Each cycle time generates a bus load according to Table 21 .
	Drives module	Each module generates a bus load according to Table 22 .	
DSP	Each DSP generates a bus load according to Table 23 .		



Table 19, Table 20, and Table 21 views only the bus load for the most common S800 I/O modules, for information about other modules see S800 User's Guide.

Table 19. Advant Fieldbus 100 Bus Load in percent for S800 Input Modules.

S800 I/O modules cycle time INSCANT/VALUE CYCLE TIME (ms)												
S800 module	2	4	8	16	32	64	128	256	512	1024	2048	4096
DI810/820	8,400	4,200	2,100	1,050	0,525	0,263	0,131	0,066	0,033	0,016	0,008	0,004
AI810/830/835	16,600	8,300	4,150	2,075	1,038	0,519	0,259	0,130	0,065	0,032	0,016	0,008
AI820	11,800	5,900	2,950	1,475	0,738	0,369	0,184	0,092	0,046	0,023	0,012	0,006

Table 20. Advant Fieldbus 100 Bus Load in percent for S800 Output Modules in Advant Controller 400 Series Master Version (Advant Controller 410, Advant Controller 450).

S800 I/O modules cycle time OUTSCANT (ms)												
S800 module	2	4	8	16	32	64	128	256	512	1024	2048	4096
DO810/820	8,416	4,216	2,116	1,066	0,541	0,279	0,148	0,082	0,049	0,033	0,025	0,021
AO810	16,632	8,332	4,182	2,107	1,070	0,551	0,292	0,162	0,097	0,065	0,049	0,041
AO820	11,823	5,923	2,973	1,498	0,761	0,392	0,207	0,115	0,069	0,046	0,035	0,029

Table 21. Advant Fieldbus 100 Bus Load in percent for S800 Output Modules in Advant Controller 400 Series
MOD 300 Version (Advant Controller 460).

S800 I/O modules cycle time VALUE CYCLE TIME/DQ CYCLE TIME (ms)												
S800 module	2	4	8	16	32	64	128	256	512	1024	2048	4096
DO810/820	8,400	4,200	2,100	1,050	0,525	0,263	0,131	0,066	0,033	0,016	0,008	0,004
AO810	16,600	8,300	4,150	2,075	1,038	0,519	0,259	0,130	0,065	0,032	0,016	0,008
AO820	11,800	5,900	2,950	1,475	0,738	0,369	0,184	0,092	0,046	0,023	0,012	0,006

Table 22 displays the generated Advant Fieldbus 100 bus load in percent at different cycle times on CYCLETIM for DRIVE units.

Table 22. Advant Fieldbus 100 Bus Load in percent for DRIVES

Module cycle time IOSCONT1 & 2 in percent												
Drive Module	2	4	8	16	32	64	128	256	512	1024	2048	4096
DRISTD	23,600	11,800	5,900	2,950	1,475	0,738	0,369	0,184	0,092	0,046	0,023	0,012
DRIENG	33,200	16,600	8,300	4,150	2,075	1,038	0,519	0,259	0,130	0,065	0,032	0,016

The total load for an engineered drive is the sum of load for IOSCONT1 and IOSCONT2, see formula:

$$\text{total load} = (\text{load generated by IOSCONT1}) + (\text{load generated by IOSCONT2})$$

The total load if IOSCONT1 is 128 ms and IOSCONT2 is 512 ms is:

$$\text{total load} = 0.519 + 0.130 = 0.649\%$$

Table 23 displays the generated Advant Fieldbus 100 bus load in percent at different cycle times on CYCLETIM for single DSPs.

Table 23. Advant Fieldbus 100 Bus Load in percent for DSPs

CYCLETIM for DSP (ms)												
DSP size	2	4	8	16	32	64	128	256	512	1024	2048	4096
1 DAT	8,400	4,200	2,100	1,050	0,525	0,263	0,131	0,066	0,033	0,016	0,008	0,004
2 DATs	9,400	4,700	2,350	1,175	0,588	0,294	0,147	0,073	0,037	0,018	0,009	0,005
3-4 DATs	11,800	5,900	2,950	1,475	0,738	0,369	0,184	0,092	0,046	0,023	0,012	0,006
5-8 DATs	16,600	8,300	4,150	2,075	1,038	0,519	0,259	0,130	0,065	0,032	0,016	0,008

Example of a calculation for an Advant Fieldbus 100 bus with following configuration:

Table 24. Calculation example Advant Fieldbus 100 (Master)

Advant Controller 450 station	1 x 0.016 =	0.016
2 DSP with 7 DAT, cycle time 128	2 x 0.259 =	0.418
3 DSP with 3 DAT, cycle time 256	3 x 0.092 =	0.276
5 DSP with 1 DAT, cycle time 64	5 x 0.263 =	1.315
S800 I/O station	1 x 0.016 + 1 x 0.032 =	0.048
3 DI 810 INSCANT 32	3 x 0.525 =	1.575
2 AI 810 INCANT 256	2 x 0.130 =	0.160
1 DO 810 OUTSCANT 64	1 x 0.279 =	0.279
1 AO 810 OUTSCANT 512	1 x 0.097 =	0.097
Advant Controller 70 station	1 x 0.016 =	0.016

Table 24. Calculation example Advant Fieldbus 100 (Continued)(Master)

1 DSP with 8 DAT, cycle time 128	1 x 0.259 =	0.259
5 DSP with 2 DAT, cycle time 256	5 x 0.073 =	0.365
Σ bus load		4.824%

Table 25. Calculation example Advant Fieldbus 100 (MOD 300)

AC 460 station	1 x 0.016 =	0.016
S800 I/O station	1 x 0.016 + 1 x 0.064 =	0.080
3 DI 810 VALUE CYCLE TIME 32	3 x 0.525 =	1.575
2 AI 810 VALUE CYCLE TIME 256,	2 x 0.130 =	0.260
1 DO 810 VALUE CYCLE TIME 64, DQ CYCLE TIME 512	1 x 0.263 + 1 x 0.033 =	0.299
1 AO 810 VALUE CYCLE TIME 512, DQ CYCLE TIME 512	1 x 0.065 + 1 x 0.065 =	0.130
Σ bus load		2.360%

The figures in [Table 19](#) to [Table 23](#) are calculated according to the formula below. The bus load depends on the CDP configuration and the configured stations and can be calculated by the following formula:

$$BusLoad = \sum \frac{Nbr \cdot Ttr}{cT} 100 \quad (<50\%)$$

Which gives the bus load in percent, where the sum is taken over all different sending DSPs and:

Nbr = number of CDPs (of the same size and cT),

Ttr = transfer time in ms (from [Table 26](#))

cT = desired cycle time in ms (2, 4, 8, 16...4096).

The transfer times for a CDP over Advant Fieldbus 100 depends of the size of the CDP (see [Table 26](#)).

Table 26. Cyclic Data Packet Transfer time

CDP size	DSP size	Transfer time (ms)
4 byte size	1 DAT element	0.168
8 byte size	2 DAT elements	0.188
12-16 byte size	3-4 DAT elements	0.236
20-32 byte size	5-8 DAT elements	0.332

Bus Load Calculation on 15000 meters

The Busload in percent is calculated according the following formula:

$$Busload = AF\ 100\ Station(load) + CI810/CI820(load) + S800\ module(load) + DSP(load)$$

Table 27. Bus Load Calculation on 8500 meters

Bus Load Calculation		
AF 100 Station	Each station, that is AC 400 Series, AC 70, CI810, and so on, sends a 4 byte message with cycle time 1024 ms. Generated bus load 0.024%.	
CI810/CI820	Each CI810 and each CI820 pair sends a 32 byte message with the following cycle times:	
	Master	1024 ms. Generated bus load 0.040%
	MOD 300	512 ms. Generated bus load 0.080%.

Table 27. Bus Load Calculation on 8500 meters

Bus Load Calculation			
S800 module	Input module	Each module generates a bus load according to Table 28	
	Output module	Master	Each module generates a bus load according to Table 29 .
		MOD 300	Each module generates a bus load according to VALUE CYCLE TIME + DQ CYCLE TIME. Each cycle time generates a bus load according to Table 30 .
	Drives module	Each module generates a bus load according to Table 31 .	
DSP	Each DSP generates a bus load according to Table 32 .		



[Table 28](#), [Table 29](#), and [Table 30](#) views only the bus load for the most common S800 I/O modules, for information about other modules see S800 User's Guide

Table 28. Advant Fieldbus 100 Bus Load in percent for S800 Input Modules.

S800 I/O modules cycle time INSCANT/VALUE CYCLE TIME (ms)												
S800 module	2	4	8	16	32	64	128	256	512	1024	2048	4096
DI810/820	12,400	6,200	3,100	1,550	0,775	0,388	0,194	0,097	0,048	0,024	0,012	0,006
AI810/830/835	20,600	10,300	5,150	2,575	1,288	0,644	0,322	0,161	0,080	0,040	0,020	0,010
AI820	15,800	7,900	3,950	1,975	0,988	0,494	0,247	0,123	0,062	0,031	0,015	0,008

Table 29. Advant Fieldbus 100 Bus Load in percent for S800 Output Modules in Advant Controller 400 Series Master Version (Advant Controller 410, Advant Controller 450).

S800 I/O modules cycle time OUTSCANT (ms)												
S800 module	2	4	8	16	32	64	128	256	512	1024	2048	4096
DO810/820	12,424	6,224	3,124	1,574	0,799	0,412	0,218	0,121	0,072	0,048	0,036	0,030
AO810	20,640	10,340	5,190	2,615	1,328	0,684	0,362	0,201	0,121	0,080	0,060	0,050
AO820	15,831	7,931	3,981	2,006	1,018	0,525	0,278	0,154	0,093	0,062	0,046	0,039

Table 30. Advant Fieldbus 100 Bus Load in percent for S800 Output Modules in Advant Controller 400 Series MOD 300 Version (Advant Controller 460).

S800 I/O modules cycle time VALUE CYCLE TIME/DQ CYCLE TIME (ms)												
S800 module	2	4	8	16	32	64	128	256	512	1024	2048	4096
DO810/820	12,400	6,200	3,100	1,550	0,775	0,388	0,194	0,097	0,048	0,024	0,012	0,006
AO810	20,600	10,300	5,150	2,575	1,288	0,644	0,322	0,161	0,080	0,040	0,020	0,010
AO820	15,800	7,900	3,950	1,975	0,988	0,494	0,247	0,123	0,062	0,031	0,015	0,008

Table 31 displays the generated Advant Fieldbus 100 bus load in percent at different cycle times on CYCLETIM for DRIVE units.

Table 31. Advant Fieldbus 100 Bus Load in percent for DRIVES

Module cycle time IOSCONT1 & 2 in percent												
Drive Module	2	4	8	16	32	64	128	256	512	1024	2048	4096
DRISTD	15,800	7,900	3,950	1,975	0,988	0,494	0,247	0,123	0,062	0,031	0,015	0,008
DRIENG	41,200	20,600	10,300	5,150	2,576	1,288	0,644	0,322	0,161	0,080	0,040	0,020

The total load for an engineered drive is the sum of load for IOSCONT1 and IOSCONT2, see formula:

$$\text{total load} = (\text{load generated by IOSCONT1}) + (\text{load generated by IOSCONT2})$$

The total load if IOSCONT1 is 128 ms and IOSCONT2 is 512 ms is:

$$\text{total load} = 0.644 + 0.161 = 0.805\%$$

Table 32 displays the generated Advant Fieldbus 100 bus load in percent at different cycle times on CYCLETIM for single DSPs.

Table 32. Advant Fieldbus 100 Bus Load in percent for DSPs

CYCLETIM for DSP (ms)												
DSP size	2	4	8	16	32	64	128	256	512	1024	2048	4096
1 DAT	12,400	6,200	3,100	1,550	0,775	0,388	0,194	0,097	0,048	0,024	0,012	0,006
2 DATs	13,400	6,700	3,350	1,675	0,838	0,419	0,209	0,105	0,052	0,026	0,013	0,006
3-4 DATs	15,800	7,900	3,950	1,975	0,988	0,494	0,247	0,123	0,062	0,031	0,015	0,008
5-8 DATs	20,600	10,300	5,150	2,575	1,288	0,644	0,322	0,161	0,080	0,040	0,020	0,010

Example of a calculation for an Advant Fieldbus 100 bus with following configuration:

Table 33. Calculation example Advant Fieldbus 100 (Master)

Advant Controller 450 station	1 x 0.024 =	0.024
2 DSP with 7 DAT, cycle time 128	2 x 0.322 =	0.644
3 DSP with 3 DAT, cycle time 256	3 x 0.123 =	0.369
5 DSP with 1 DAT, cycle time 64	5 x 0.388 =	1.940
S800 I/O station	1 x 0.024 + 1 x 0.040 =	0.064
3 DI 810 INSCANT 32	3 x 0.775 =	2.325
2 AI 810 INCANT 256	2 x 0.161 =	0.322
1 DO 810 OUTSCANT 64	1 x 0.388 =	0.388
1 AO 810 OUTSCANT 512	1 x 0.120 =	0.120
Advant Controller 70 station	1 x 0.024 =	0.024
1 DSP with 8 DAT, cycle time 128	1 x 0.322 =	0.322
5 DSP with 2 DAT, cycle time 256	5 x 0.105 =	0.525
Σ bus load		7.283%

Table 34. Calculation example Advant Fieldbus 100 (MOD 300)

AC 460 station	1 x 0.024 =	0.024
S800 I/O station	1 x 0.024 + 1 x 0.080 =	0.104

Table 34. Calculation example Advant Fieldbus 100 (Continued)(MOD 300)

3 DI 810	VALUE CYCLE TIME 32	3 x 0.775 =	2.325
2 AI 810	VALUE CYCLE TIME 256,	2 x 0.161 =	0.322
1 DO 810	VALUE CYCLE TIME 64, DQ CYCLE TIME 512	1 x 0.388 + 1 x 0.048 =	0.436
1 AO 810	VALUE CYCLE TIME 512, DQ CYCLE TIME 512	1 x 0.080 + 1 x 0.080 =	0.160
Σ bus load			3.371%

The figures in [Table 28](#) to [Table 32](#) are calculated according to the formula below. The bus load depends on the CDP configuration and the configured stations and can be calculated by the following formula:

$$BusLoad = \sum \frac{Nbr \cdot Ttr}{cT} 100 \quad (<50\%)$$

Which gives the bus load in percent, where the sum is taken over all different sending DSPs and:

Nbr = number of CDPs (of the same size and cT),

Ttr = transfer time in ms (from [Table 35](#))

cT = desired cycle time in ms (2, 4, 8, 16...4096).

The transfer times for a CDP over Advant Fieldbus 100 depends of the size of the CDP (see [Table 35](#)).

Table 35. Cyclic Data Packet Transfer time

CDP size	DSP size	Transfer time (ms)
4 byte size	1 DAT element	0.248
8 byte size	2 DAT elements	0.268
12-16 byte size	3-4 DAT elements	0.316
20-32 byte size	5-8 DAT elements	0.412

Bandwidth fragmentation

All load calculations that are shown in the previous chapters concerns calculations of the average busload. There is however one additional factor that must be considered when configuring the Advant Fieldbus 100, that is bandwidth fragmentation. It can not be taken for granted that the bus can use all of the 70% (2000 m) or 50% (8500/15000 m) bandwidth.

Bandwidth fragmentation means that the 1 ms time slots can not house a CDP even though the CDP load would below the maximum 70% (2000 m) or 50% (8500/15000 m). This is illustrated with the example below:

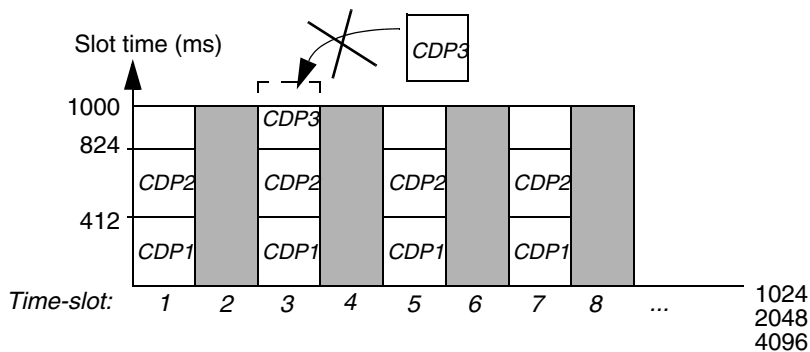

Figure 56. Fragmented CDP (15000 meter configuration)

Example

Bandwidth fragmentation on a bus configured for 15000m:

In Figure 56 two 32 bytes CDPs, CDP1 and CDP2, are configured with cycle time 2 ms each. These cause a bus load of 40,9%. One additional 32 bytes CDP (CDP 3) in Figure 56 with cycle time 1024 ms would cause additional 0.4% busload. This makes the total busload 41.3% which is less than the 50% limit. It is though not possible to add CDP 3 since it is only $1000^1 - 2 \cdot 412 = 176$ microseconds left in each time slot.

1. In reality up to 1008 μ s height of the time slot can be used for CDPs. This implies that a slot can house four 32 byte CDPs for 2000 meters and six 4 byte CDPs for 8500 meters.

Bandwidth fragmentation appears on 2000 m, 8500 m and 15000 m bus lengths but is more obvious the longer bus length that is used since the transfer times for each CDP increases with the bus length.

Due to bandwidth fragmentation the guaranteed achievable CDP busload is 33.4% for 8500 meter and 29.4% for 15000 meter.

One way to try to circumvent the bandwidth fragmentation is to change the sizes of the CDPs and the cycle times.

Transmission Constraints

Due to the organization of the scan table (and the entire operating principles of the communication interface firmware) some constraints are imposed on the Advant Fieldbus 100 transmissions.

In order to guarantee that message transfer is possible, at least 25% of the time slots on 2000 meter and 50% on 8500 and 15000 meters are reserved for message transfer.

The rest of the time slots may be used freely for CDP communication. The practical maximum bus load value depends on the configuration. This is dependent on the combination of very fast CDPs (for example 1-2 ms) with very slow ones (that is 2048 and 4096 ms). As soon as one CDP with cycle time 2048 ms is used the time slot table is made wider but lower, see [Figure 33](#). For 4096 ms the width is even more increased and height decreased.

The following rules must be observed when configuring the Advant Fieldbus 100:

- The bus load (calculated as in [Section , Configuration of Advant Fieldbus 100](#)) caused by CDPs having a cycle time of 1 ms must be less than or equal to 50% in total.
- The maximum bus load on 2000m bus length (calculated as in [Section , Configuration of Advant Fieldbus 100](#)) is 70%. For 8500m and 15000m the maximum bus load is 50% (calculated according to [Section , Configuration of Advant Fieldbus 100](#) and [Section , Configuration of Advant Fieldbus 100](#)).
- The maximum bus load could be further limited (below 70% and 50%) by bandwidth fragmentation for the current CDP configuration, see Chapter .
- No 1ms CDPs are allowed on a bus configured for 8500 or 15000m.

- The number of CDPs configured in **each Communication Interface** must be less than the maximum the module can handle, which means 3999 for CI520, CI526 and CI522, 200 for CI626, 100 for CI625 and 50 for PM810.



The number of CDP available for DSP and S800 I/O is 3999 minus # of stations.

Message Transfer Rates

As message transfer is event driven (and thus non-deterministic), it is difficult to specify transfer rates. It is, however, possible to specify the maximum throughput in a system where all the band-width available for process data has been used. In such a system, no more than about 100 kbits per second can be employed for message transfer.

Note that this transfer rate includes protocol information in the packets and acknowledgments which carry no message data. The net user data transfer rate will thus be somewhat less.

Time tagged events by means of EventSet are sent as Message Transfer. Unless any other Message Transfer messages are performed Advant Fieldbus 100 can handle ten events per second.

Station Supervision

Station Supervision in the Advant Controller 400 Master

In the Advant Controller 400 Series it is possible to supervise stations on the bus. For this purpose three station data base elements can be used, the AF 100 Station (in DB elements denominated AF100S), the Advant Controller 110 (in DB elements denominated AC110) and the Advant Controller 70 (in DB elements denominated AC70). The three different data base elements are described below.

AF 100 Station

The AF100S DB element is used for supervision of other stations connected to the bus. It is a general DB element for AF 100 Stations. The element gives information of the status of the specified station. Example of possible values in the TYPE terminal are:

AC 800M	(AC 800M controller)
AC 450	(Advant Controller 450)
AC 410	(Advant Controller 410)
AC 160	(Advant Controller 160)
ASFW	(AdvaSoft for Windows)
AF100 OPC	(OPC server 1.x, 2.y, y >=1)
AF100 NT	(OPC server 2.0)
AC 100 OPC	(AC 100 OPC Server 3.1 and later)

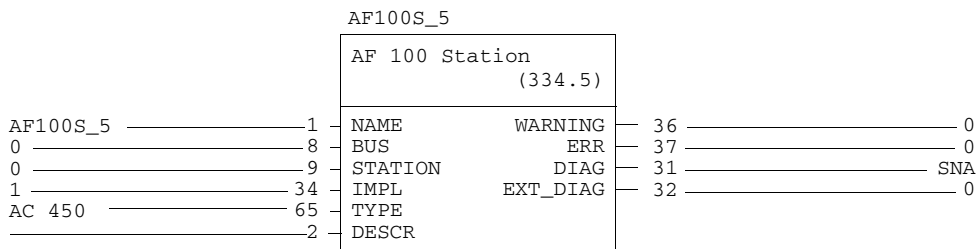

Figure 57. DB Element for AF 100 Station with TYPE terminal set to Advant Controller 450

Advant Controller 110 Station

The Advant Controller 110 Station DB element is a special case of the AF 100 Station which is used when the station is an Advant Controller 110.

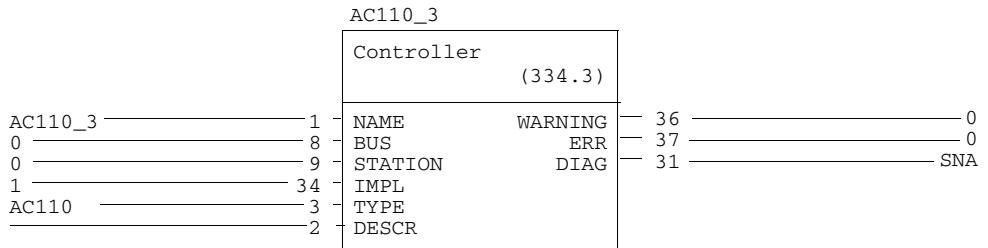

Figure 58. DB Element for Advant Controller 110

Advant Controller 70 Station

The Advant Controller 70 Station DB element is a special case of the AF 100 Station which is used when the station is an Advant Controller 70.

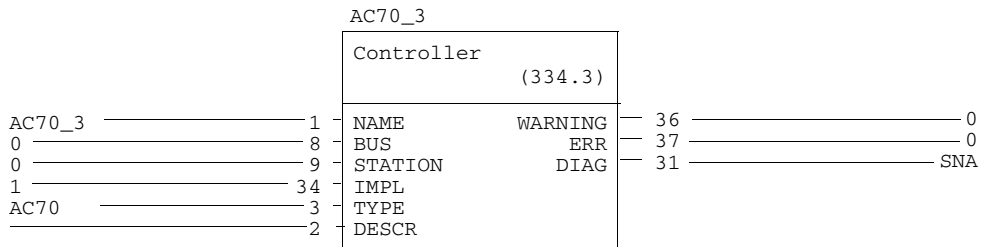

Figure 59. DB Element for Advant Controller 70

Station Supervision in AC 100 Series

Advant Controller 110/160

The AF 100 Station data base element specifies a general type of station connected to Advant Fieldbus 100. It must support services to report diagnostic information in

the same way as any Advant Controller. If an Advant Controller 110/160 is connected, additional information regarding redundancy or multiprocessing can be found in Related Documentation.

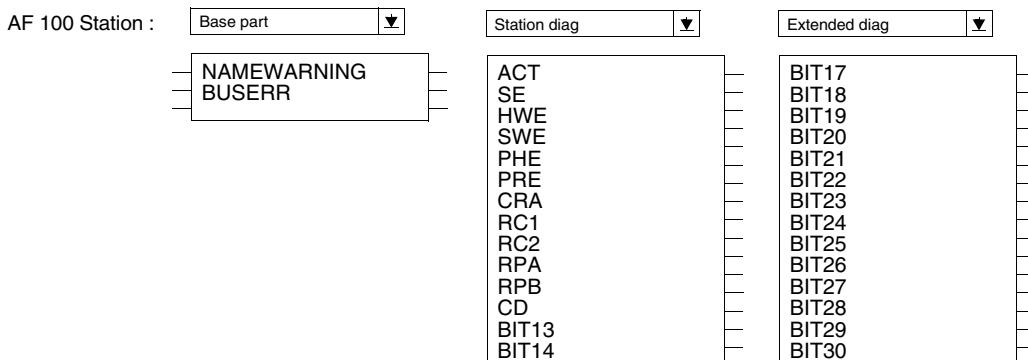

Figure 60. DB Element for Advant Controller 110/160

AF 100 Station and Advant Controller 70/110 Station Status information

To reach status information of other stations connected to the bus, the DB elements AF 100 Station, Advant Controller 70 or Advant Controller 110 is used. The status information is given by the DIAG terminal which can show the following information:

Table 36. Terminal Description

Status Information	Description	Remarks
ACT	Station is ACT ive and executing, the application is in normal operation mode.	–
SE	Severe station Error : Severe errors in the station, no application is executing.	Check connected station.

Table 36. Terminal Description (Continued)

Status Information	Description	Remarks
HWE	Station HardWare Error . An error condition in station hardware, with the application execute.	Non-fatal error in the connected station.
SWE	Station SoftWare Error : The application is not executing correctly. Restart of the station (and possibly reload of application) clears the error.	Check application program in the connected station.
PHE	Peripheral Hardware Error . Hardware errors or missing hardware in peripheral equipment that the station controls, for example local or remote I/O devices.	Check hardware in connected station.
PRE	PRocess Errors : "Soft" error condition in application program, application objects report errors, for example I/O channel is out of range.	Possible I/O hardware or input signal error in the connected station.
CRA	Cable Redundancy Available : Indicates that the station is configured to have redundant bus cables.	Station is configured to have redundant media.
RC1	Redundant Cable 1 failed : Indicates that the communication over the cable 1 of the redundant cable pair does not work.	Replace media (cable 1).
RC2	Redundant Cable 2 failed : Indicates that the communication over the cable 2 of the redundant cable pair does not work.	Replace media (cable 2).
RPA	Redundant Power A failure.	Check power supply unit A.
RPB	Redundant Power B failure.	Check power supply unit B.

Table 36. Terminal Description (Continued)

Status Information	Description	Remarks
CD	Changed D iagnostics.	–
BIT13	BIT number 13 of station diagnostics.	Reserved for future use.
BIT14	BIT number 14 of station diagnostics.	Reserved for future use.
GE	General station E rror.	Check connected station.
GW	General W arning.	Check connected station.
IDF	I Dentity F ailure	Only in AC 400 Master Check station number and type on the database element.
SNA	S tation N ot A ccessible	Only in AC 400 Master. Check station number and type on the database element. Check that the station is connected to the bus.

The SE, SNA, IDE, SWE, and GE gives error on the DB element, inactive ACT (NOT ACT) and the rest except CD and CRA gives warning.

I12 - I13 Not yet defined.

Station supervision in AC 800M

The three hardware units (under the CI869 hardware unit in the hardware tree) that are used for AF 100 station supervision are:

- AF 100 Station with DSPs
- AF 100 Station
- My AF 100 Station Status

AF 100 Station with DSPs

The hardware unit, *AF 100 Station with DSPs*, represents an AF 100 station on the AF 100 bus. The station, for example, can be an Advant Controller (AC 160 or AC 400).

The position number for the *AF 100 Station with DSPs* represents both the station number for this station and the Major DSP ID.

Figure 61 shows the hardware tree for an AF 100 bus, where the CI869 is sending DSPs with Major ID 2 (and station number 2), and is receiving DSPs through stations 1 and 21.

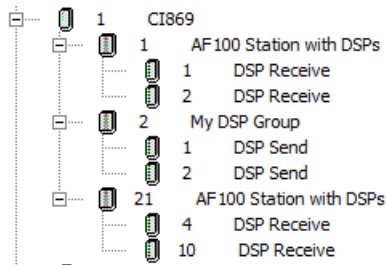

Figure 61. Hardware tree with AF 100 Station with DSPs at position 1 and 21

AF 100 Station

The hardware unit, *AF 100 Station*, represents an AF 100 station on the AF 100 bus. The station, for example, can be an Advant Controller (AC 160 or AC 400).

For each *AF 100 Station*, a receiving Station Status CDP is configured on the CI869 for supervision of a remote station on the bus. Its content is presented as part of Unit Status in the hardware editor of *AF 100 Station*.

The *AF 100 Station* can be placed at positions 4001 to 4080.

The *AF 100 Station* is only a representation of an AF 100 station on the bus with the station number equal to the two last digits of the position number (1..80) in the hardware tree.

It is not possible to add *DSP Receive* and *DSP Send* hardware units to the *AF 100 Station* hardware unit.

The *AF 100Station* is recommended to be used if the DSPs use Major IDs that are not related to station numbers on the bus. If the Major IDs of the DSPs are equal to the *AF 100 Station* number, it is recommended to use the hardware type *AF 100 Station with DSPs*.

Figure 62 shows a hardware tree configuration under CI869 with the *AF 100 Station* hardware units at positions 4001 and 4022.

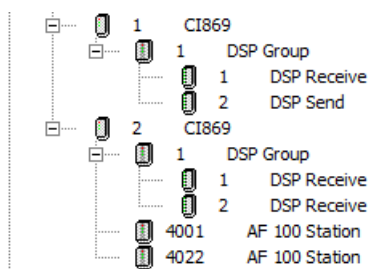

Figure 62. Hardware tree with *AF 100 Station* at position 4001 and 4022

Unit Status for AF 100 Station and AF 100 Station with DSPs

The unit status corresponding to the contents of the station status CDP are displayed under the Unit Status tab of the respective hardware configuration editor.

[Table 37](#) provides the details of the Unit Status corresponding to the two hardware units – *AF 100 Station* and *AF 100 Station with DSPs*.

Table 37. Unit Status for AF 100 Station and AF 100 Station with DSPs

Value	Displayed Message and its Description	Status Type	Indication	Alarm/Event	Severity
0x80000000	Source not polled. No master frame for the CDP on the bus.	ErrorsAndWarnings	Error	-	-
0x40000000	Source no response. Master Frame but no Slave Frame for the CDP on the bus	ErrorsAndWarnings	Error	-	-
0x20000000	Owned by other station. The master could not consider this CDP because it is already in use.	ErrorsAndWarnings	Error	-	-
0x10000000	Bus full. The master could not add this CDP because the bus is full.	ErrorsAndWarnings	Error	-	-
0x08000000	Possible collision. Check-sum error on Slave Frame possible due to collision.	ErrorsAndWarnings	Error	-	-
0x04000000	Station status valid. The CDP data is valid.	ErrorsAndWarnings	-	-	-

Table 37. Unit Status for AF 100 Station and AF 100 Station with DSPs

Value	Displayed Message and its Description	Status Type	Indication	Alarm/Event	Severity
0x00000001	Inactive. Station is not active and executing, the application is not in normal operation mode (inverse of ACT bit from the Station Status CDP)	ExtendedStatus	Warning	-	-
0x00000002	Severe error. Severe station error: Severe errors in the station, no application is executing.	ExtendedStatus	Error	-	-
0x00000004	HW error. Station HW error. An error condition in the station hardware, which the application execute.	ExtendedStatus	Warning	-	-
0x00000008	SW error. Station SW error: The application is not executing correctly.	ExtendedStatus	Error	-	-
0x00000010	Peripheral HW error. Peripheral hardware error. Hardware errors or missing hardware in peripheral equipment that the station controls, for example local or remote I/O devices.	ExtendedStatus	Warning	-	-

Table 37. Unit Status for AF 100 Station and AF 100 Station with DSPs

Value	Displayed Message and its Description	Status Type	Indication	Alarm/Event	Severity
0x00000020	Process Error. Process errors: "Soft" error condition in application program, application objects report errors, for example I/O channel is out of range.	ExtendedStatus	Warning	-	-
0x00000040	Line Redundancy Available. Cable redundancy available: Indicates that the station is configured to have redundant bus cables.	ExtendedStatus	-	-	-
0x00000080	Station reports Line 1 error. Redundant cable 1 failed: indicates that the communication over the cable 1 of the redundant cable pair does not work.	ExtendedStatus	Warning	-	-
0x00000100	Station reports Line 2 error. Redundant cable 2 failed: Indicates that the communication over the cable 2 of the redundant cable pair does not work.	ExtendedStatus	Warning	-	-
0x00000200	Red Power A error. Redundant Power A failure.	ExtendedStatus	Warning	-	-

Table 37. Unit Status for AF 100 Station and AF 100 Station with DSPs

Value	Displayed Message and its Description	Status Type	Indication	Alarm/Event	Severity
0x00000400	Red Power B error. Redundant Power B failure	ExtendedStatus	Warning	-	-
0x00000800	Changed Diagnostics	ExtendedStatus	-	Event	Low
0x00004000	Gen Error. General (unspecified) station error.	ExtendedStatus	Error	-	-
0x00008000	Gen Warning. General (unspecified) station warning.	ExtendedStatus	Warning	-	-
0x00040000	No connection. Station status CDP not received	ExtendedStatus	Error	-	-
0x00080000	No connection cable 1. Station status CDP not received on Channel 1.	ExtendedStatus	Warning	-	-
0x00100000	No connection cable 2. Station status CDP not received on Channel 2	ExtendedStatus	Warning	-	-

My AF 100 Station Status

The *My AF 100 Station Status* hardware unit contains IO channels that are used to populate the status bits in the Station Status CDP.

An IO channel in *My AF 100 Station Status* represents any of the following status:

- Active
- Severe Error
- HW Error
- SW error
- Peripheral HW error
- Process error
- Redundancy power A failure
- Redundancy power B failure
- General station error
- General station warning
- Unit status

Using *My AF 100 Station Status* is optional. Updating its channels makes the standard station status supervision more informative. For example, AC 100 Connect is able to show a relevant overview of the operation of all stations on the bus.

It is recommended to connect the variables that are updated from the IEC 61131 application to the channels of *My AF 100 Station Status*, so that the status information is presented.

After a configuration is downloaded, the CI869 always sends its Station Status CDP, regardless of whether the *My AF 100 Station Status* CDP hardware unit is added to the hardware tree or not. All the bits controlled by the IEC 61131 application are set to zero if the *My AF 100 Station Status* hardware unit is not used.

The *My AF 100 Station Status* hardware unit is always placed at position 4000. It displays the status of the connected CI869.

Section 4 Installation and Start-up

For Advant Fieldbus 100, three types of media can be used:

- Twisted Pair
- Coaxial
- Optical

This section describes the installation and start up of an Advant Fieldbus 100 network.

Modem Installation - General

The instructions in this section apply to both electrical and optical modems. The modem must be grounded in the same manner as the other units on the same Advant Fieldbus 100. This can be achieved by mounting the units on a mutually conductive base, such as a mounting plate or DIN rail.

For information regarding modem installation, refer to the *Advant OCS Installation Rules* manual.



All electrical installation work must be performed in accordance with national safety regulations and the safety rules for the ABB Advant OCS system.

Installing the Network

This chapter provides information about the installation of communication interfaces, modems, bus cables, terminators, and so on. For information about the installation of the individual station, except for the aspects that relate to communication, refer to the relevant documentation of the concerned product.

Cable Installation - General

For information regarding cable installation, refer to the *Advant OCS Installation Rules* manual.

Installing Twisted Pair Cable

Advant Controller 70, S800 I/O Stations, Advant Controller 400 Series, and PC based operator station can be connected to the twisted pair media. The twisted pair modems are integrated within the Advant Controller 70 and the S800 I/O Station units. To connect an Advant Controller 400 Series and PC based operator station, the external modem TC512/TC516 is needed. Both single and redundant twisted pair media can be used.

For Advant Controller 110, the unit CI627 is used and for Advant Controller 160 the unit CI627 and CI631 are used. Both CI627 and CI631 has two integrated twisted pair modems.

The Advant Fieldbus 100 cables are connected to removable terminal headers which are connected to the TC512/TC516 modems, the Advant Controller 70 or the S800 I/O Station. This allows the station or modem to be removed from the Advant Fieldbus 100 without disconnecting other nodes on the fieldbus.

When connecting the twisted pair bus cable to a modem both an incoming (from previous station) and an outgoing bus cable (to next station) are connected to the bus cable connector on the modem. This can be performed using the TC505 (see [Chapter , Installation and Start-up](#)) or by connecting the bus cables directly to the modem connector. To the two communication interfaces located first and last on the bus, only one bus cable, incoming or outgoing, is connected. The bus cable for these two stations must be terminated with a twisted pair bus termination.



The blue wire of the terminators must be connected to ground at one end of the bus segment.

The minimum distance between two stations (modems) on the twisted pair cable is 4 meters (13 feet).

Connection of Twisted Pair Cable to CI527

Figure 63 displays details for connection of a twisted pair bus cable to CI527.

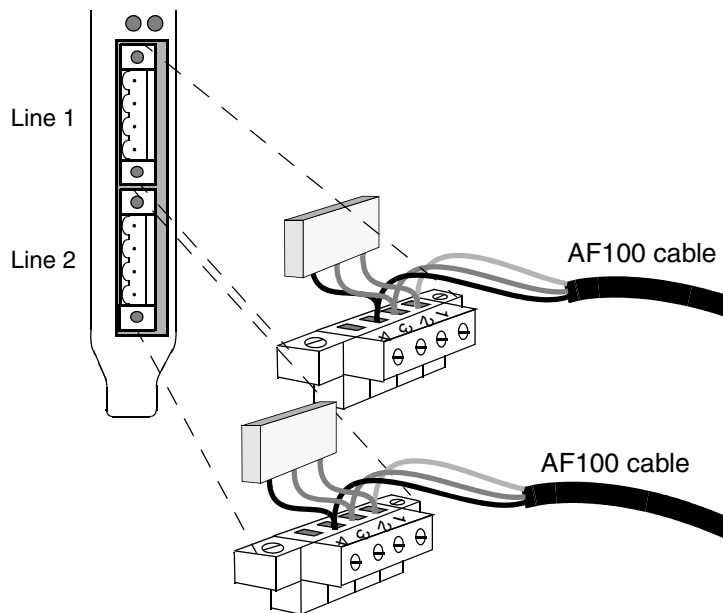

Figure 63. Installing the Bus Cable on CI527

CI527 twisted pair connector

Table 39 shows the fieldbus connection assignments.

Table 38. CI527 Twisted Pair Connections, Line 1, Line 2

Pin	Designation	Description
1	+	+ Signal
2	-	- Signal
3	SH	Direct Coupled Shield
4	SH	Capacitive Coupled Shield

Pin 3 is to be used when external capacitive decoupling of the twisted pair cable shield is used for instance with TC506 or with the TX505 For more information, see chapter and chapter .

Pin 4 is to be used when no external capacitive decoupling of the twisted pair cable shield is used, for instance when TC505 is used For more information see chapter .

Connection of Twisted Pair Cable to Modem TC512/TC516

The modem TC512/TC516 connects to the Advant Fieldbus 100 via the terminals on its front, connector X3. When redundant media is used two TC512/TC516 modems are needed, one for each bus line to be connected to the communication interface.

Figure 64 views the connection details for connection of a twisted pair bus cable to the modem TC512/TC516.

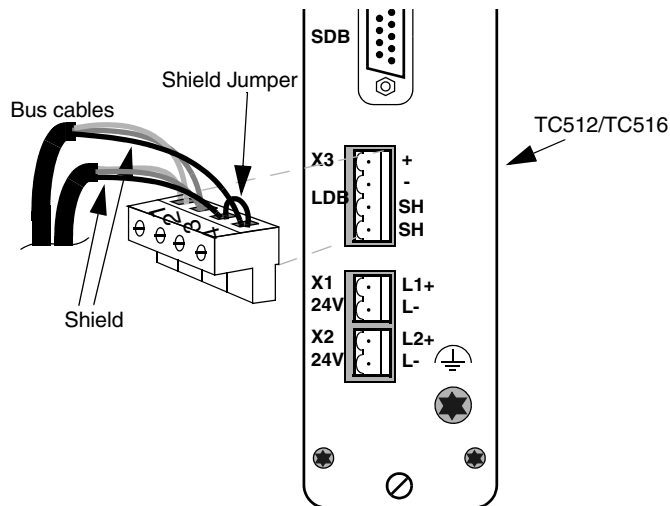

Figure 64. Installing the Bus Cable on TC512/TC516

Table 39 shows the fieldbus connection assignments.

Table 39. TC512/TC516 Fieldbus Connections, Connector X3

Pin	Designation	Description
1	+	+ Signal
2	-	- Signal
3	SH	Shield ⁽¹⁾
4	SH	Shield

(1) Should be jumpered to Pin 4 Shield

Connection of S800 I/O Station and Advant Controller 70 to Twisted Pair Media

The S800 I/O Station and the Advant Controller 70 connects to the Advant Fieldbus 100 via terminals on its front. When single media is used it must be connected to line 1, (X2). See Figure 65 for connection details.

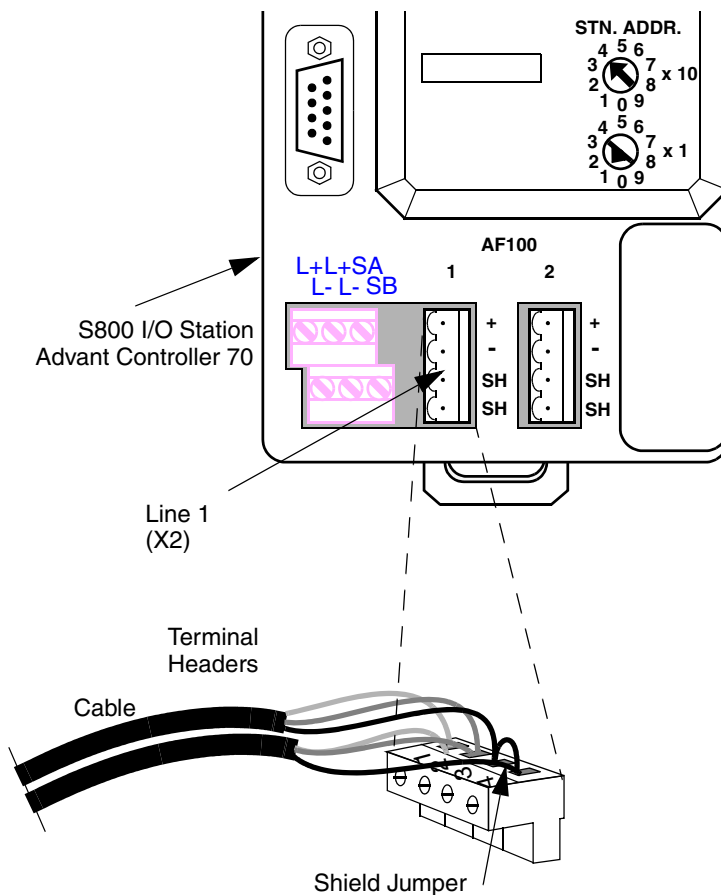

Figure 65. S800 I/O Station and AC 70 Fieldbus Terminal Connections

Table 40 shows the fieldbus connection assignments.

*Table 40. S800 I/O Station and Advant Controller 70 Fieldbus Connections,
Line 1 X2, Line 2 X3*

Pin	Designation	Description
1	+	+ Signal
2	-	- Signal
3	SH	Shield ⁽¹⁾
4	SH	Shield

(1) Should be jumpered to Pin 4 Shield

Connection of S800 I/O Station and Advant Controller 70 to Twisted Pair Media with Redundant Cables

The S800 I/O Station and the Advant Controller 70 connects to the Advant Fieldbus 100 via the terminals on its front. When redundant media is used the Advant

Fieldbus 100 is connected to line 1 and 2 of the station. See [Figure 66](#) for connection details.

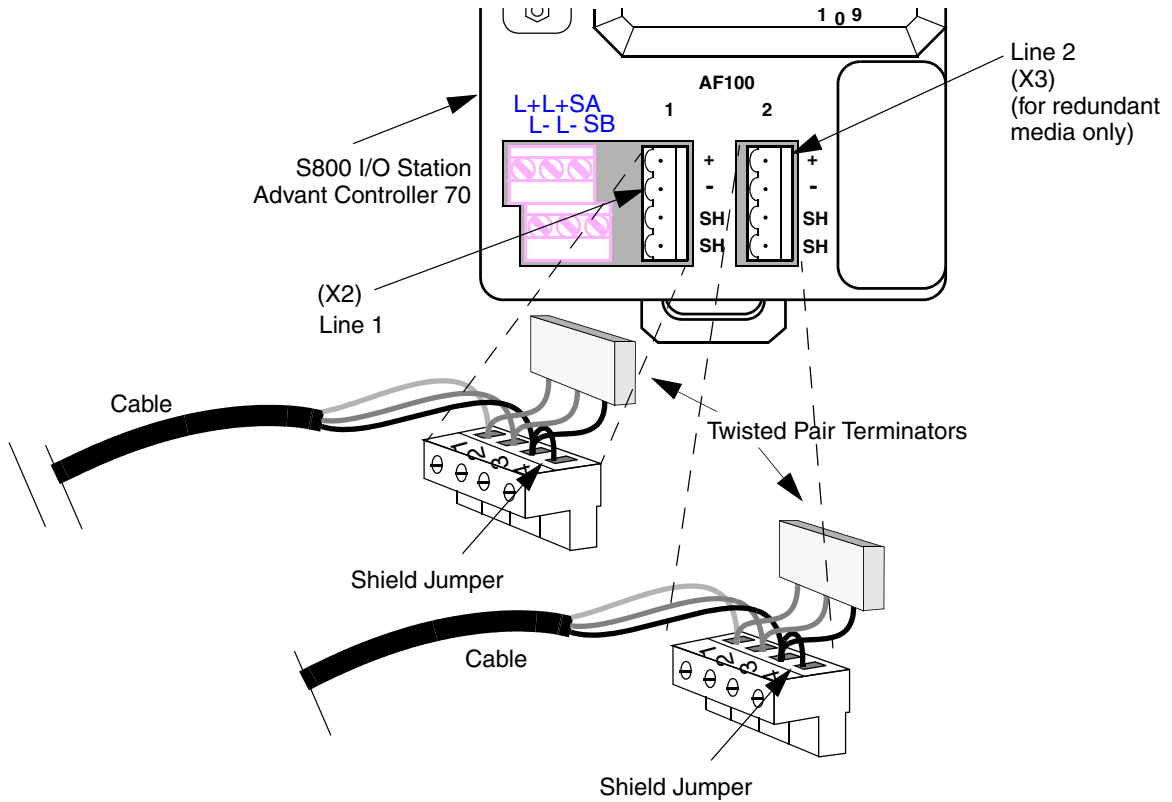

Figure 66. S800 I/O Station and Advant Controller 70 Fieldbus Terminal Connections

Table 41 shows the fieldbus connection assignments.

*Table 41. S800 I/O Station and Advant Controller 70 Fieldbus Connections,
Line 1 X2, Line 2 X3*

Pin	Designation	Description
1	+	+ Signal
2	-	- Signal
3	SH	Shield ⁽¹⁾
4	SH	Shield

(1) Should be jumpered to Pin 4 Shield

Connection of Connection Unit TC505/TC506

When connecting a station to the twisted pair bus the incoming and outgoing cable can either be connected directly to the terminal header or via the connection unit TC505/TC506. The TC505/TC506 is typically used when the station is mounted in a cabinet. The TC505/TC506 connection unit is mounted on a DIN rail in the cabinet.

TC505 has no capacitive decoupling between the shield and ground in the connection unit, and is meant to be used within a cabinet which has a separate capacitive decoupling itself. See [Figure 67](#) and [Figure 70](#).

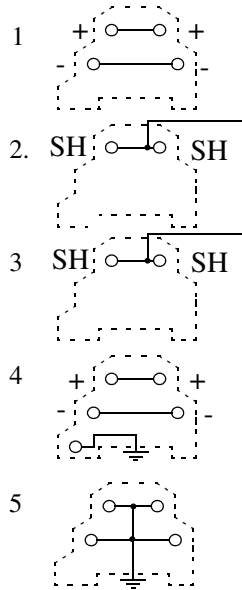

Figure 67. TC505, Circuit Diagram.

TC506 has a capacitive decoupling between the shield and ground in the connection unit and is meant to be used when the installation is made without a cabinet or within a cabinet which does not have a capacitive decoupling itself. See [Figure 68](#).

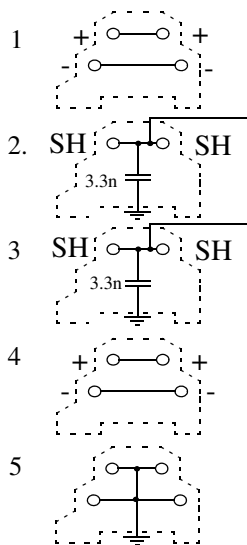

Figure 68. TC506, Circuit Diagram

[Figure 69](#) illustrates the connection of twisted pair cable using TC505/TC506

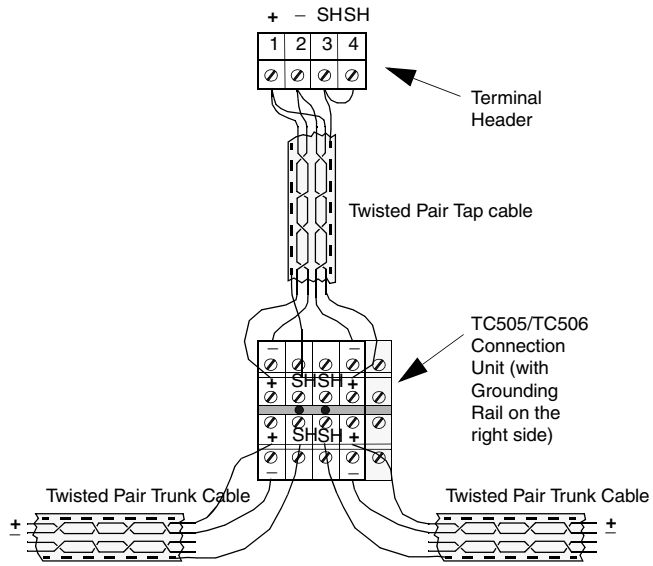

Figure 69. Schematic Image of One Twisted Pair Media Drop Connection

Table 42 shows the fieldbus connection assignments for TC505/TC506.

Table 42. Advant Fieldbus 100 Connection Unit TC505/TC506

Terminal designation	Description
	GND
	Not connected
+	+ Signal 1
-	- Signal 1
SH	Shield
	Not connected
SH	Shield
	Not connected
+	+ Signal 2
-	- Signal 2

Table 43 shows the fieldbus connection assignments for the terminal headers.

Table 43. CI810 (FCI) Fieldbus Connections, Line 1 X2, Line 2 X3

Pin	Designation	Description
1	+	+ Signal
2	-	- Signal
3	SH	Shield ⁽¹⁾
4	SH	Shield

(1) Should be jumpered to Pin 4 Shield

TX507 Capacitive Decoupling Unit

The TX507 capacitive decoupling unit shall be mounted at the cable entrance in cabinets for Advant Controller 400 Series and Advant Controller 110. The TX507 units is used for capacitive decoupling of shields of communication cables. One TC507 unit can be used for maximum four communication cables. The purpose with the TX507 unit is to decrease emission levels.

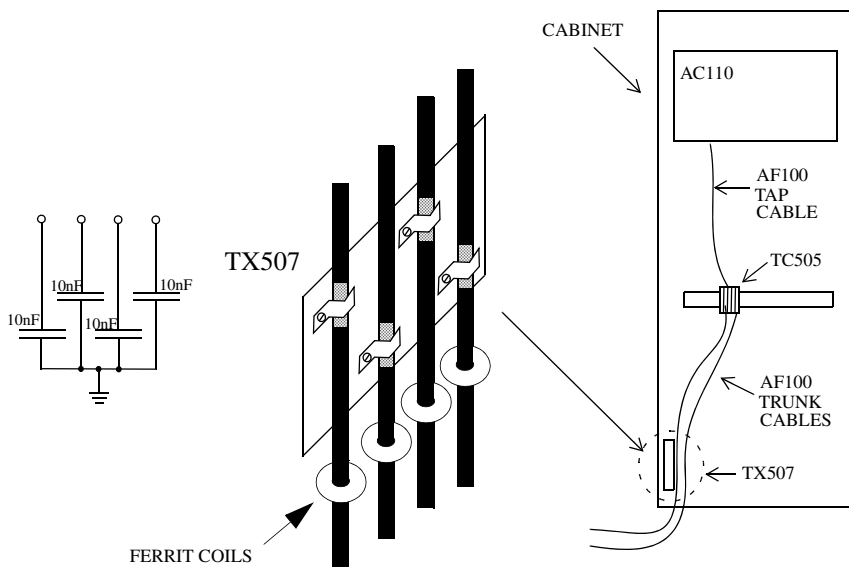

Figure 70. TX507, Capacitive Decoupling Unit

Connection of Connection Unit TC505/TC506 with Redundant Cables

When connecting a station to the twisted pair bus with redundant cables the incoming and outgoing cables can either be connected directly to the terminal header or via the connection unit TC505. TC505 is typically used when the station is mounted in a cabinet. The TC505 connection unit is mounted on a DIN rail in the cabinet.

Figure 71 illustrates the connection of twisted pair cable using TC505.

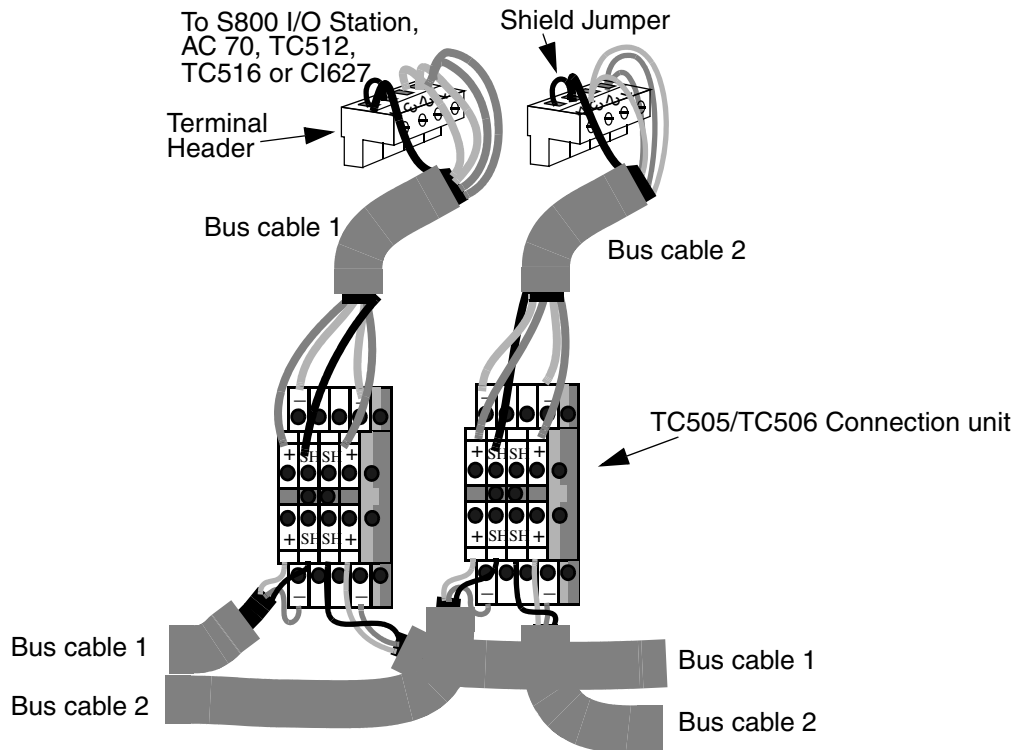

Figure 71. Installing the Bus Cable on TC505- Twisted Pair Redundant Cables

Termination and Grounding of Twisted Pair cables

Termination of the twisted pair cable is performed with a pre-designed termination unit.

The termination must have the same resistance as the cable used. For example, the

150 ohm cable, IBM Type 1, is terminated with the 150 ohms termination unit TC501V150.

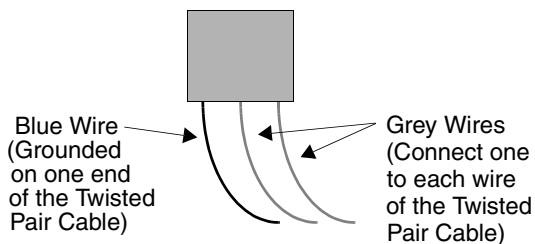

Figure 72. TC501V150 Termination Unit for Twisted Pair Cable

Table 44 shows the fieldbus connection assignments for terminator unit TC501V150.

Table 44. Twisted Pair Termination Unit

Designation	Wire color	Description
S1	Grey	+ Signal
S2	Grey	- Signal
GND	Blue	Shield

The bus cable must be grounded, **but in one end only**. This is done by grounding the termination unit GND wire.

Figure 69 illustrates the termination of the Advant Fieldbus 100 twisted pair cable. It shows the termination in the first and the last stations. At the first station the terminator GND wire is connected to ground. At the last station the terminator GND wire is not connected at all. It is only the outermost, that is the first and the last stations, on the bus segment that are terminated.

TERMINATION PRINCIPLE:

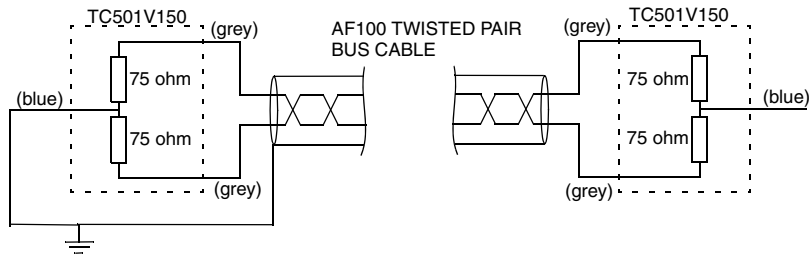

TERMINATION BY USING TC505 AND TC501V150:

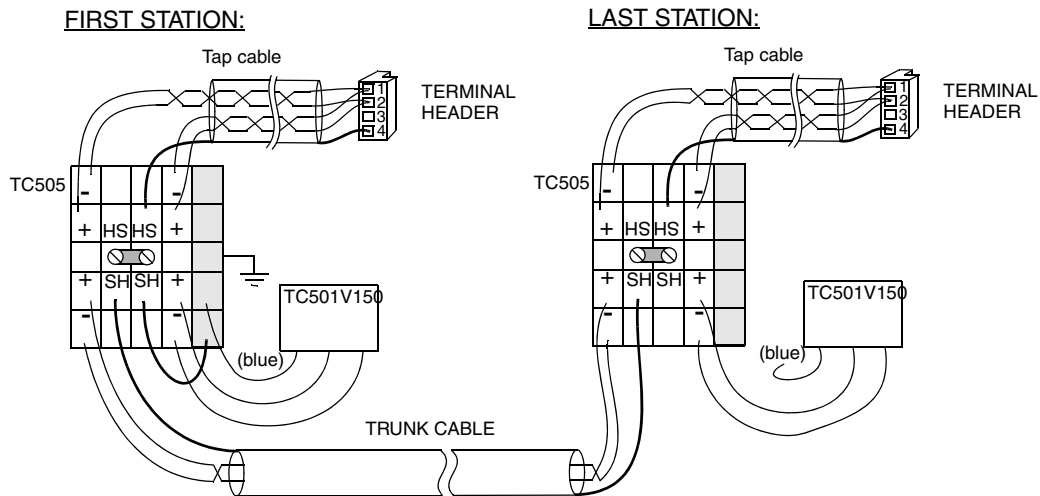

Figure 73. Installing the Twisted Pair Termination unit

Installation of Single Twisted Pair Bus

When connecting a CI520/CI522/CI526 to the bus the communication interface is connected to the TC512 modem with modem cable TK515/TK593/TK803. Units with integrated modems are connected directly to the bus cable.

When single media is used the bus cable must be connected to the Line 1 connector on Advant Controller 70 (PM810) and S800 I/O Station (CI810).

Figure 74 illustrates a twisted pair media installation.

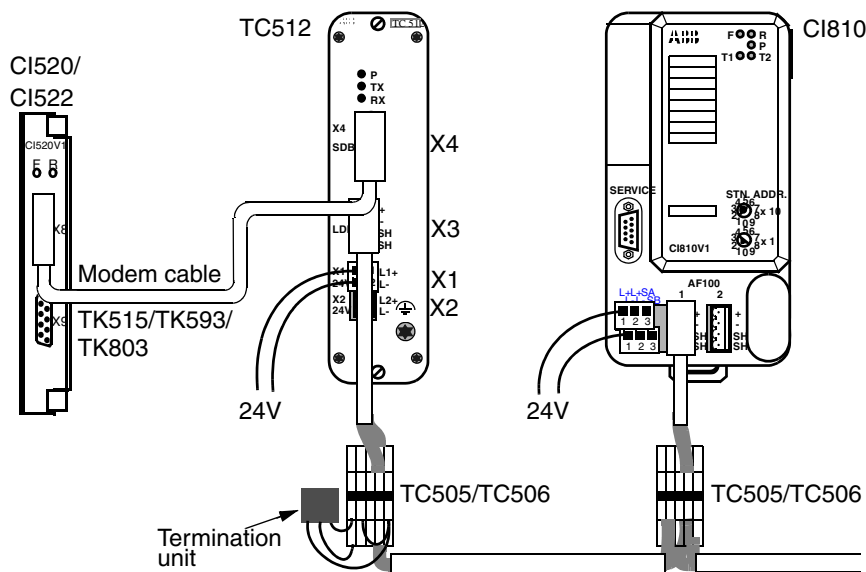
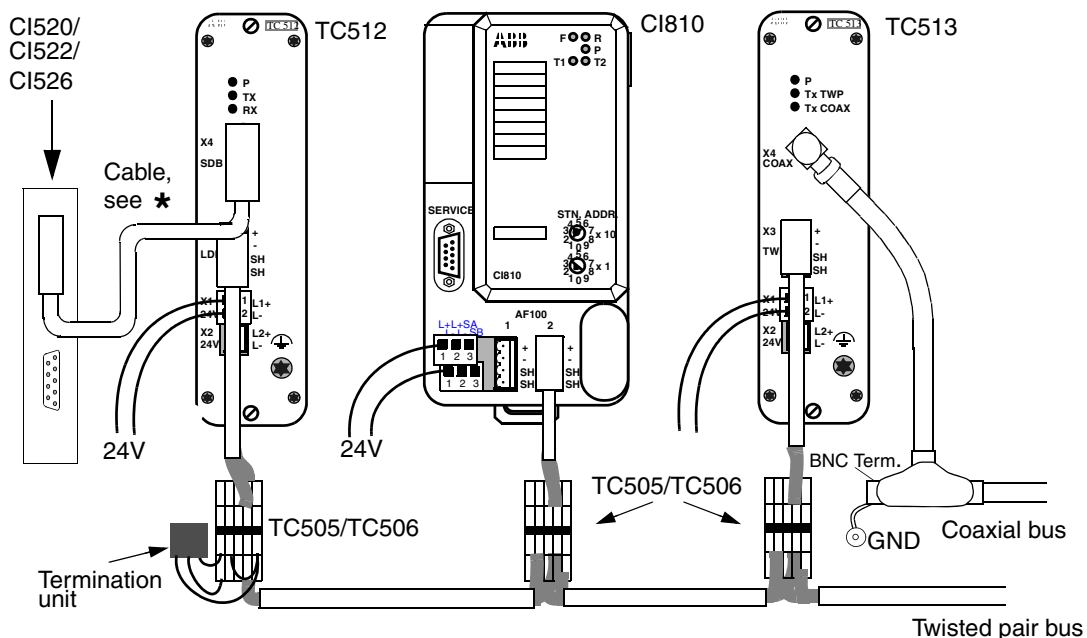

Figure 74. Twisted Pair Single Bus Configuration

TC512	X1, X2	2-pol Jack Screw-connector
TC512	X3	4-pol Jack Screw-connector
TC512	X4	DIN 9-pol connector

Figure 75 illustrates a twisted pair media installation with conversion to coaxial media.



- * For CI520 - Use cable TK515 (AC 450/AC 460) or TK593 (AC 410)
- For CI526 - Use cable TK515
- For CI522 - Use cable TK803V018 (AC 450/AC 460) or TK803V036 (AC 410)

Figure 75. Single Twisted Pair Configuration with Media conversion

TC513	X1, X2	2-pol Jack Screw-connector
TC513	X3	4-pol Jack Screw-connector
TC513	X4	DIN 9-pol connector.

Installation of Redundant Twisted Pair Bus¹

When connecting a CI520/CI522/CI526 to the redundant bus each line 1 and 2 on the communication interface is connected to one TC512/TC516 modem with modem cable TK515/TK593/TK803. For units with integrated modems, each line 1 and 2 is connected directly the bus cable 1 resp. 2.

[Figure 76](#) illustrates a redundant twisted pair media installation with conversion to coaxial media. See also [Figure 1](#) and [Figure 2](#) to learn more about media respective communication interface redundancy for Advant Controller 450.

1. Consult [Table 6](#) for information about communication interfaces supporting redundant media

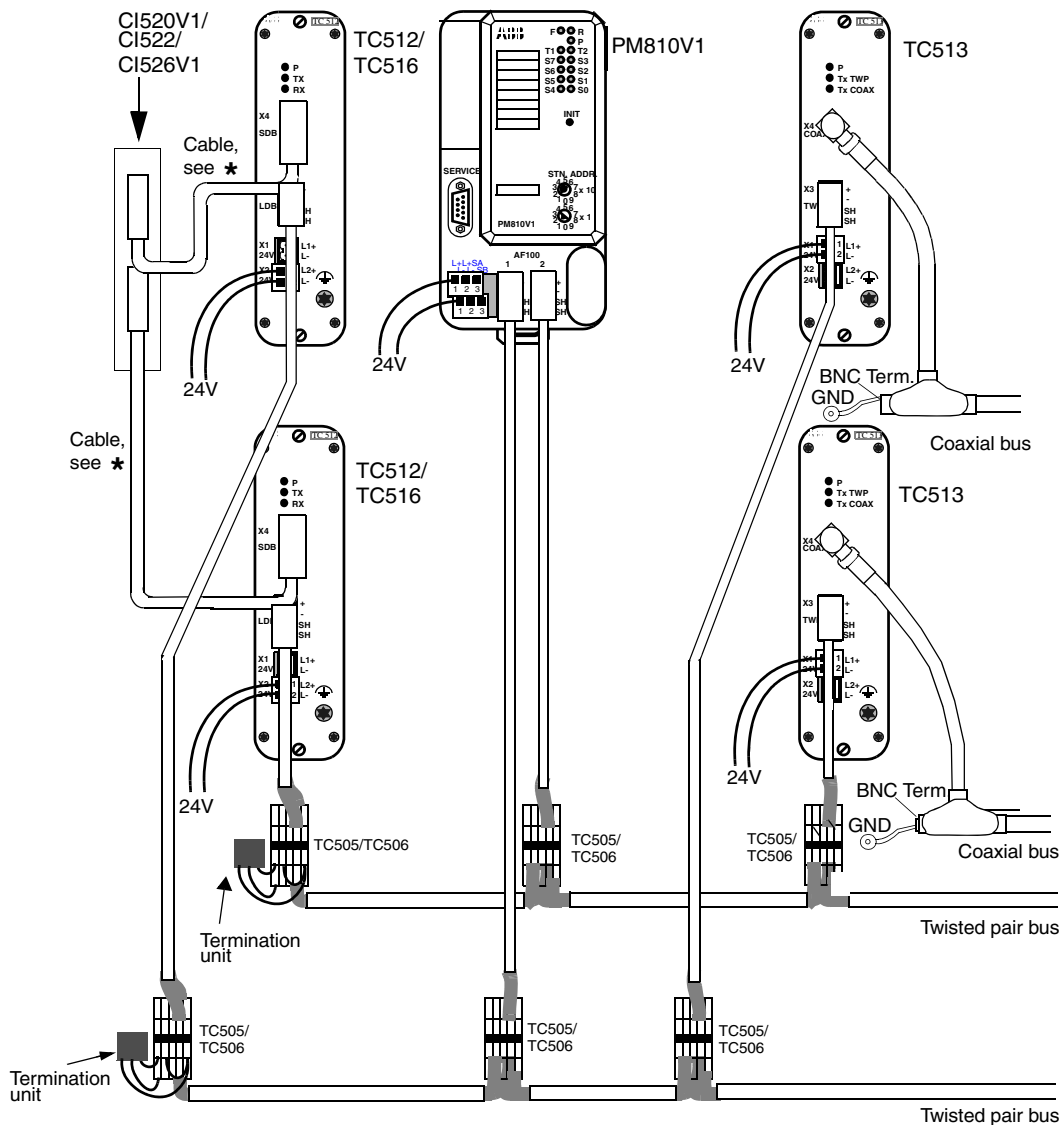

- * For CI520V1 - Use cable TK515 (AC 450/AC 460) or TK593 (AC 410)
- For CI526V1 - Use cable TK515
- For CI522 - Use cable TK803V018 (AC 450/AC 460) or TK803V036 (AC 410)

Figure 76. Redundant Twisted Pair Configuration with Media conversion

Installing Redundant CI522 and Twisted Pair modem TC516

Twisted pair modem TC516 has two connectors to be used for redundant CI522s. Each TC516 connects one channel from each CI522 to the corresponding AF 100 Bus cable. This means that for instance channel one from CI522 Module 1 is connected to connector X4 on one TC516 and channel one on CI522 module 2 is connected to X5 on the same TC516. The TC516 connector X3 is then connected to AF 100 bus cable 1. The same applies for the two CI522s channel 2 which are connected to the other TC516. This second TC516 is then connected to AF 100 bus cable 2.

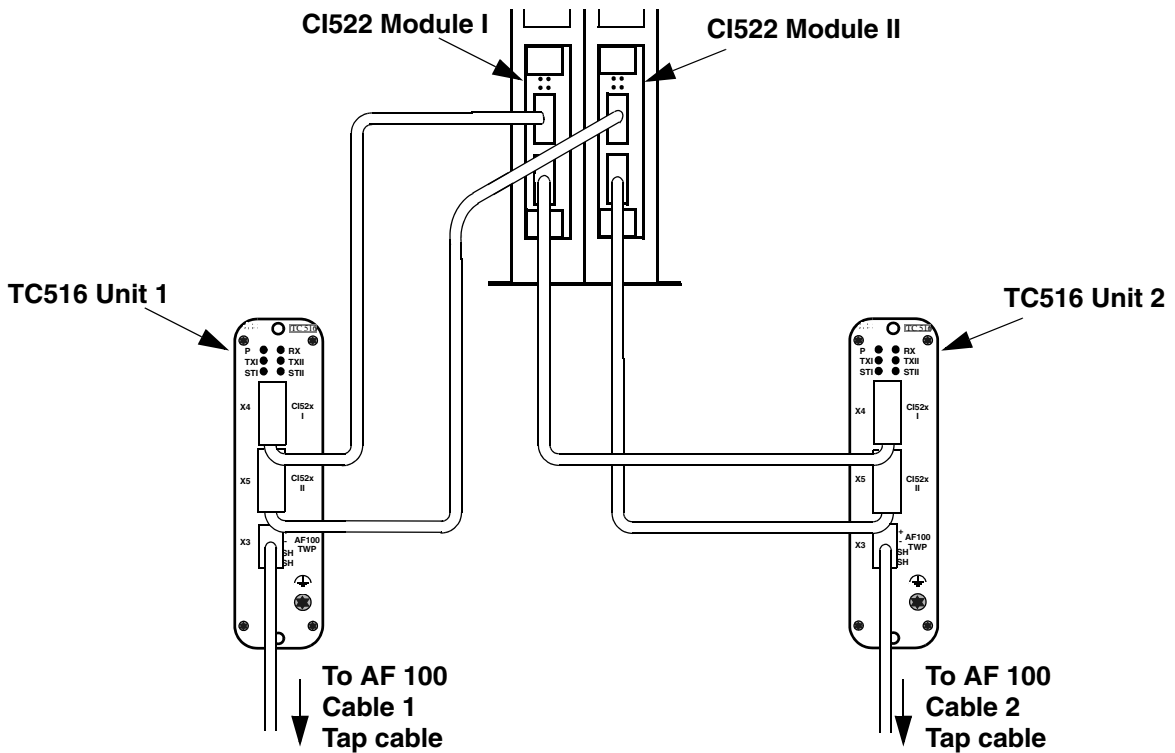

CI522		TC516	
Module number	Channel number	Unit number	Connector
I	1	1	X4
	2	2	X4
II	1	1	X5
	2	2	X5

Table 45. Connection of CI522 to TC516 when using redundant CI522s

Installing Coaxial Cable

Installation of Single Coaxial Bus Cable

For each connected communication interface there will be two bus cables that are connected to the communication interface, one leading to the previous communication interface and one leading to the next. These are connected using a BNC T-connector.

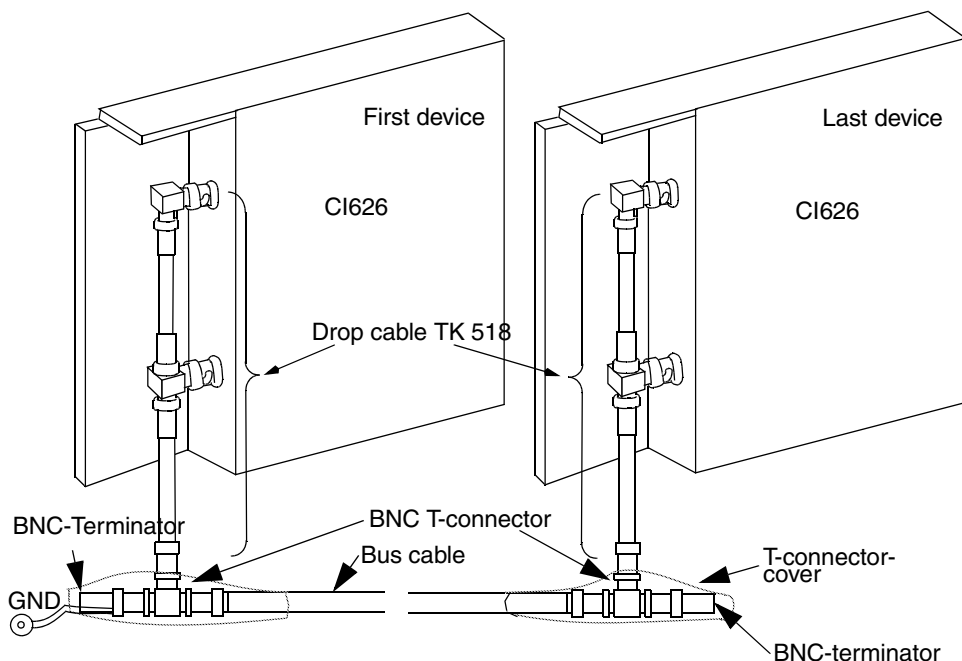

Figure 77. Installing the Coaxial Bus Cable

From the BNC T-connector the connection to the BNC bus connector on the device is done over the drop cable TK516 (modem) or TK518 (CI626/CI630) and a right angle connector. During operation the T-connector section must be isolated which is achieved using the T-connector cover (see [Figure 77](#)).

The bus cable must be terminated in both ends. In the two communication interfaces situated at the end of the bus, only one bus cable is connected. The other part of the BNC T-connector is used for termination of the bus with the bus terminator plug.

The bus cable must be grounded, **but only in one end of the bus segment**. This is done by grounding the wire on the bus termination plug in one (and only one) end of the cable.

For installation with redundant cables, each of the two cables must be grounded.

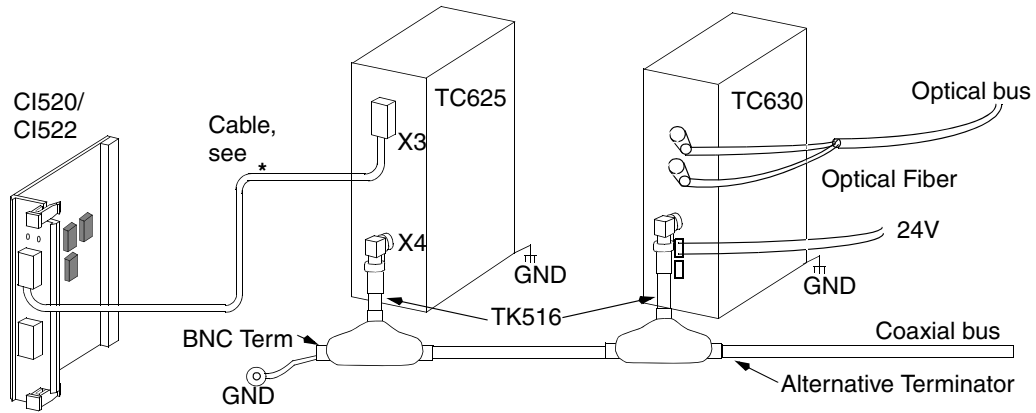

- * For CI520 - Use cable TK515 (AC 450/AC 460) or TK593 (AC 410)
- For CI526 - Use cable TK549
- For CI522 - Use cable TK803V018 (AC 450/AC 460) or TK803V036 (AC 410)

Figure 78. Optical Bus Configuration

TC625 X3 9-pol D-SUB, PIN

TC625 X4 75 ohm, BNC-connector jack.

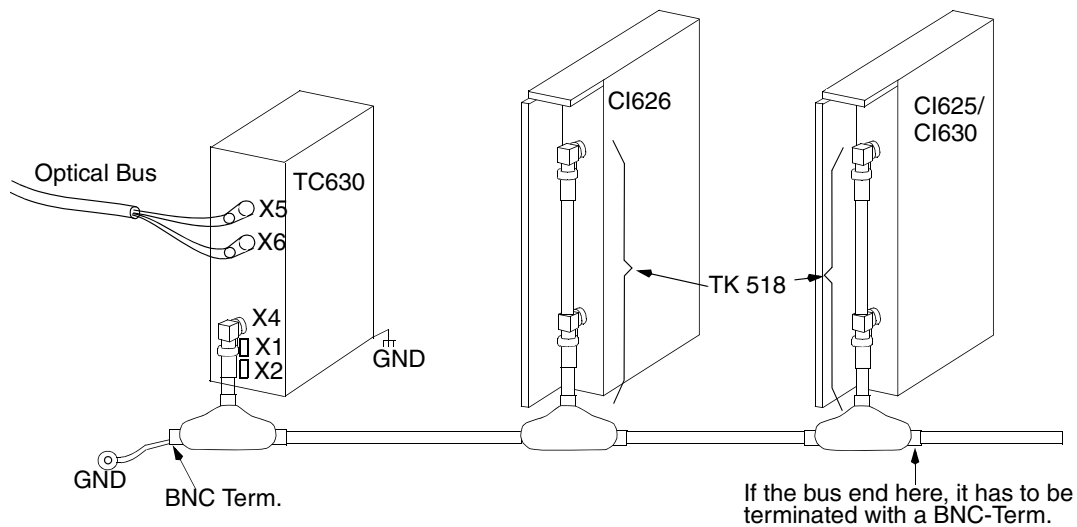
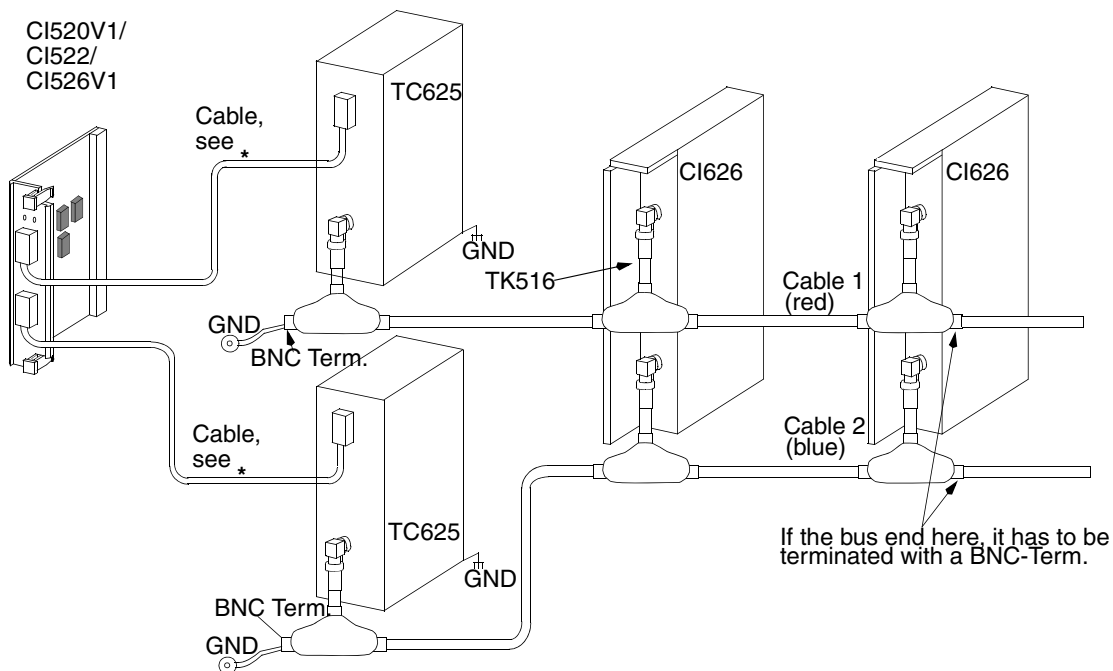

Figure 79. Optical Bus Configuration

- TC630 X1, X22-pol Jack SCREW-connectors
- TC630 X4 75 ohm BNC connector jack
- TC630 X5, X6 Optical connectors ST-style.

Installation of Redundant Coaxial Cable

The user must also choose between a single bus media installation and a redundant media installation. In the redundant case two bus media are needed for each communication interface, as depicted in [Figure 80](#).



- * For CI520V1 - Use cable TK515 (AC 450/AC 460) or TK593 (AC 410)
- For CI526V1 - Use cable TK549
- For CI522 - Use cable TK803V018 (AC 450/AC 460) or TK803V036 (AC 410)

Figure 80. Redundant Coaxial Bus Cable installation

When redundant cable is used, different colors for the bending protection are used to easily identify the lines (red for cable 1, blue for cable 2).

NOTES

Furthermore, the user must make sure that the cable length between any two stations on the bus is less than 1200 meter (3600 ft.). The communication on Advant Fieldbus 100 will not operate properly if this is not observed.

See [Table 6](#) for information concerning equipment capability.

If the cable is connected to the cable 1 connector it must be connected to the same connector on all communication interfaces.

Termination and Grounding of Coaxial Cables

The basic rules concerning Advant Fieldbus 100 terminations are as follows:

- Coaxial segments of an Advant Fieldbus 100 must be terminated on **both** ends.
- The coaxial sections end points **MUST** be terminated with a 75 ohm BNC terminating plug.

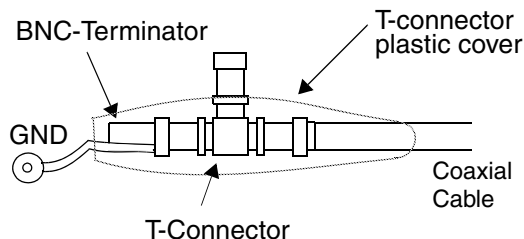

Figure 81. BNC Terminating Plug with Grounding Connection Wire

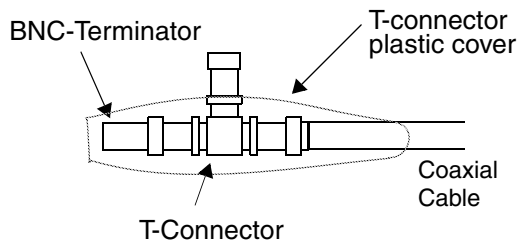

Figure 82. BNC Terminating Plug without Grounding Connection Wire

Shielding

The following rules generally apply with regard to the connection of Advant Fieldbus 100 to modems and modems:

- The shielding, when Coaxial or twisted pair cable is used, **must be** grounded. The shielding is grounded in **one end only**.
- All cable shielding connections **must be shorter than 50 mm ($\approx 2''$)**.

For further information regarding cable shield grounding and installation, please refer to the manual *Advant OCS Installation Rules*.

Connection of optical modem

The optical twin pair cable is installed between two optical modems. One of the two fibers in the cable shall be connected to the TX optical connector on the first optical modem and the RX connector on the second optical modem. The other fiber cable shall be connected in the opposite way, in the RX connector on the first optical modem and TX optical connector on the second optical modem.

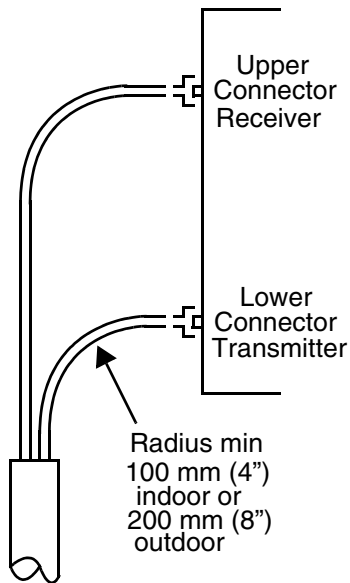

Figure 82-1. Side View of the Optical Connectors of TC514

The modem TC514 is connected to the dual fiber cable of the Advant Fieldbus 100 via the lower (transmitter) and upper (receiver) optical ST connectors.



It is recommended that optical connectors be screwed in place with the fingers as the threads on the connectors can be easily damaged if tools are used.

Sufficient space should remain beneath the modem to permit a certain minimum bending radius of the cable (R in the figure above). This radius depends on the cable type and is normally 100 mm for apparatus cable and cable for indoor industrial environments. For underground and submarine cable, a radius equal to or greater than 200 mm ($\approx 8''$) is normally required. The manufacturer of the cable should be contacted in the event of uncertainty.

Contact the optical cable manufacturer about info how to handle the optical cable during installation. The installation of optical connectors on the cable is a precision work which should be performed by specialists. The cable supplier can usually recommend such experts.

The optical connectors are of the ST type.

Starting an Advant Controller 70

When the network has been installed, the Advant Controller 70 (PM810) can be started.

Initial Start-up

When an Advant Controller 70 communication interface is started, its CDPs are be configured. As the communication interface can not be a Bus Administrator, its CDPs are configured on the Bus Administrator which currently is master. This is performed when the Advant Controller 70 is started and connected to the bus or when a Bus Administrator configured as master has started.

At start up all LEDs on the Advant Controller 70 front are lit for about a second during the hardware init.

The station is running when the R (RUN) indicator is lit.

Selecting Station Address

Before starting the Advant Controller 70, it must have been assigned a station number. The station number is selected with the address switches on the PM810 front. The station number must be in the range of 1 to 79. Please refer to the Advant Controller 70 documentation for further information.

The station address has no relation to the order of the stations along the bus. They merely represent physical addresses which are used to refer to specific stations.

The Advant Controller station number acts as the hardware address of the communication interface on the Advant Fieldbus 100.

Restarting Advant Controller 70

There is no difference between starting the first time, and later.

LED Indicators on PM810

When starting (or restarting) a PM810, the LEDs (T1 and T2) concerning Advant Fieldbus 100 on the front panel are handled as follows.

All LEDs are lit during the hardware init, about one second. The R (RUN) LED is lit when the station is running. The T1 and T2 Leds are lit when the modem can detect any bus traffic (receiving or sending) on line 1 respective line 2.

Exchange of a PM810

To exchange a PM810, the following procedure must be followed.

As the Advant Fieldbus 70 can not be bus master the communication between other nodes can not be disturbed while exchanging PM810s.

Before taking the new PM810 into operation the application must be loaded to the station and the station must be assigned the same station number as the replaced station.

Starting an Advant Controller 110 with a CI626/CI627

When the network has been installed, the Advant Controller 110 can be started.

Initial Start-up

When a CI626/CI627 communication interface is powered on for the first time, it has an invalid configuration in its nonvolatile memory.

The consequence of this is that the entire configuration table is deleted (that is no CDPs are configured anywhere as far as this communication interface is concerned).

The error indication on the CI626/CI627 is lit until the CI626/CI627 communication interface is restarted.

The error indication has no consequences for the operation of the communication interface.

It is merely a normal start up condition, and may be ignored.

Selecting Station Address

Before inserting the communication interface CI626/CI627 into the Advant Controller 110 backplane, the user must select a station address (in the range 1 - 79) on the Advant Controller 110.

The station address is selected on the thumb-wheel switch at the lower left of the backplane containing the basic station (refer to the Advant Controller 110 documentation for further information).

The station address has no relation to the order of the stations along the bus. They merely represent physical addresses which are used to refer to specific stations.

The Advant Controller 110 station number acts as the hardware address of the communication interface on the Advant Fieldbus 100. Note that the communication interface CI626/CI627 must be inserted in the second slot in the Advant Controller 110 backplane if it should be able to read the station address from the thumb-wheel.

Restarting Advant Controller 110

When restarting a communication interface, the configuration stored in nonvolatile memory will be valid, and the communication interface will use the loaded parameters rather than the default parameters. Otherwise, there is no difference between starting the first time, and later.

LED Indicators on CI626/CI627

When starting (or restarting) a CI626/CI627 communication interface, the LEDs of the front panel, are handled as follows.

The red “FAULT” LED is on, the green “RUN” LED is off, as are all the yellow LEDs. During initialization of the communication interface, the “MASTER” LED will be turned on, and the “CONFIG OK” LED will flash shortly while the scan table is generated

When the initialization is done and the relevant hardware checks are performed, the “FAULT” LED goes off indicating that the CI626/CI627 communication interface is ready to be configured.

When it has been configured it is automatically set operational (by the CPU), which is indicated by turning on the green “RUN” LED.

The Traffic LED is lit when the modem can detect any bus traffic (receiving or sending) on the line 1 or line 2.

Exchange of a CI626/CI627

To exchange a CI626/CI627 communication interface (for example in case of failure), the following procedure must be followed.

If the transmission between the other still remaining communication interfaces shall not be disturbed it is important to make sure that the communication interface is never removed while the LED “MASTER” is on. This can be achieved by switching off the power of the affected station or removing the bus cable immediately after the LED “MASTER” goes off (which means that the responsibility for the bus master function has been passed over to the next communication interface). The remaining communication interfaces will automatically continue to share the bus master responsibilities between them and ignore the removed station.

To replace the communication interface with another CI626/CI627 communication interface, just insert the new one in the slot from which the old one was removed, and insert and fix the bus cables. The CPU in Advant Controller 110 will automatically detect that the communication interface has been exchanged, and reload the user defined configuration into the new communication interface.

Be sure the station number is not changed while exchanging CI626/CI627s. If the station number is changed the whole bus might need to be restarted.

Starting an Advant Controller 400 Series with a CI520/CI522

When the network has been installed, it is time to start Advant Controller stations.

Initial Start-up

When a CI520/CI522 communication interface is started for the first time, it has an invalid configuration in its nonvolatile memory.

The consequence of this is that the entire configuration table is deleted (that is no CDPs are configured anywhere as far as this communication interface is concerned).

Selecting Station Address

On the Advant Controller 400 Series the station number is specified in the CI520/CI522 data base element.

The station address have no relation to the order of the stations along the bus. They merely represent physical addresses which are used to refer to specific stations.

Restarting Advant Controller 400 Series

When restarting a communication interface, the configuration stored in nonvolatile memory will be valid, and the communication interface will use the loaded parameters rather than the default parameters. Otherwise, there is no difference between starting the first time, and later.

LED Indicators on CI520

When starting (or restarting) a CI520 communication interface, the LEDs of the front panel are handled as follows:

1. The red “FAULT” LED is on, the green “RUN” LED is off.
2. When the initialization is done and the relevant hardware checks are performed, the “FAULT” LED goes off indicating that the CI520 communication interface is ready to be set operational.
3. When it has been configured it is automatically set operational (by the CPU), which is indicated by turning on the green “RUN” LED.

Exchange of a CI520

In order to minimize the disturbance during exchange of a communication interface, for example in case of failure, the following procedure should be followed:

1. Reset the IMPL terminal on the CI520 data base element.
2. Remove the modem cable from the CI520 HW-module.
3. Change CI520 modules.
4. Connect the modem cable to the new CI520.
5. Set the IMPL terminal on the CI520 data base element.

The Advant Controller 400 Series will automatically detect that the communication interface has been exchanged, and reload the proper configuration into the new communication interface.



Be sure the station number is not changed while exchanging CI520s. If the station number is changed the whole bus might need to be restarted.

LED Indicators on single CI522

When starting (or restarting) a CI522 communication interface, the LEDs of the front panel are handled as follows:

1. The red “FAULT” LED is on, the green “RUN” LED is off.
2. When the initialization is done and the relevant hardware checks are performed, the “FAULT” LED goes off indicating that the CI522 communication interface is ready to be set operational.
3. When it has been configured it is automatically set operational (by the CPU), which is indicated by turning on the green “RUN” LED.

LED Indicators on redundant CI522

When starting (or restarting) a CI522 redundant communication interface, the LEDs of the front panel are handled as follows:

1. The red “FAULT” LED is on, the green “RUN” LED is off.
2. When the initialization is done and the relevant hardware checks are performed, the “FAULT” LED goes off indicating that the CI522 communication interface is ready to be set operational.
3. In the beginning of the configuration of the CI522 the “PRIMARY” LED is lit on the module to become primary.
4. When it has been configured it is automatically set operational (by the CPU), which is indicated by turning on the green “RUN” LED.
5. When a CI522 in a redundant communication interface pair is in redundancy mode, the “DUAL” LED is lit.

Exchange of a single CI522

The CI522 is connected to two interface units. In order to minimize the disturbance during exchange of a communication interface, for example in case of failure, the following procedure should be followed:

1. Reset the IMPL terminal on the CI522 data base elements.
2. Remove the modem cables from the CI522 HW-module.
3. Change CI522 modules.
4. Connect the modem cable to the new CI522.
5. Set the IMPL terminal on the CI522 data base elements.

The Advant Controller 400 Series will automatically detect that the communication interface has been exchanged, and reload the proper configuration into the new communication interface.



Be sure the station number is not changed while exchanging CI522s. If the station number is changed the whole bus might need to be restarted.

Exchange of a redundant CI522



Before doing any changes of modules according to the specification below, please check that the CI522 versions are exchangeable.

The CI522 is connected to two interface units. In order to minimize the disturbance during exchange of a communication interface, for example in case of failure, the following procedure should be followed:

1. Remove the modem cables from the back-up CI522 HW-module.
2. Change the back-up CI522 modules.
3. Connect the modem cable to the new module.
4. Generate a change-over by setting the CH_OVER-terminal on the CI522 DB-element to “yes” or ordering a change-over from the Operator Station.
5. The former back-up is now primary and the former primary has become back-up.
6. Remove the modem cables from the new back-up CI522 HW-module.

7. Change the back-up CI522 modules.
8. Connect the modem cable to the new module.

The Advant Controller 400 Series will automatically detect that the communication interface has been exchanged, and reload the proper configuration into the new communication interface.



Be sure the station number is not changed while exchanging CI522s. If the station number is changed the whole bus might need to be restarted.

Starting an S800 I/O Station

When the network has been installed, the S800 I/O Station (CI810) can be started. The S800 I/O Station is subordinated an Advant Controller and can not start while the superior station is not started up on the bus.

Initial Start-up

An S800 I/O Station is configured and started from a superior Advant Controller. At start up the Advant Controller initiates the CI810 before it sends the configuration parameters to the CI810. The CI810 configures according to the received parameters. As the communication interface can not be a Bus Administrator its CDPs are configured on the Bus Administrator currently being a bus master.

The station is running when the R (RUN) indicator is lit.

Selecting Station Address

Before powering up of the CI810, it must have been assigned a station number. The station number is selected with the address switches on the CI810 front. **The station number must be in the range of 1 to 79.** Please refer to the S800 I/O documentation for further information.

The station address has no relation to the order of the stations along the bus. They merely represent physical addresses which are used to refer to specific stations.

The CI810 station number acts as the hardware address of the communication interface on the Advant Fieldbus 100.

Restarting S800 I/O Station

There is no difference between starting the first time, and later.

LED Indicators on CI810

When starting (or restarting) a CI810, the LEDs concerning Advant Fieldbus 100 of the front panel are handled as follows:

1. All LEDs are lit during the hardware init, about one second.
2. The R (RUN) LED is lit when the station is running.
3. The T1 and T2 Leds are lit when the modem can detect any bus traffic (receiving or sending) on line 1 respective line 2.

Exchange of a CI810

As the CI810 cannot be bus master the communication between other nodes can not be disturbed while exchanging CI810s.

The new CI810 is started from the Advant Controller as at the initial start up.

Starting an AC 800M Controller with CI869

For information about the start-up of AC 800M controller and CI869, and the LED indicators, see the *AC 800M Controller Hardware and Operation (3BSE036351*)* manual.

Exchange of Single CI869

A CI869 module connected to an AC 800M controller through the CEX-bus can be exchanged with another CI869 module, without switching off the power to the controller.



The new CI869 module must have a firmware version compatible to the AC 800M System software.



The communication with this station on the AF 100 bus is interrupted during exchange of the module.

To exchange a CI869 module:

1. Remove the CI869 unit from its termination plate.
2. Insert the new CI869 unit to the termination plate.

The AC 800M controller automatically detects that the communication interface is exchanged, and reloads the proper configuration to the new communication interface.

Exchange of a Redundant CI869

In a redundant configuration, the primary and backup CI869 modules connected to the AC 800M controller through the CEX-bus can be exchanged with new CI869 modules, without switching off the power to the controller.



The new CI869 module must have a firmware version compatible to the AC 800M System software.



The communication with this station on the AF 100 bus is not interrupted during exchange of the redundant modules.

To exchange redundant CI869 modules:

1. Remove the CI869 unit that functions as backup, from its termination plate.
2. Insert the new CI869 backup unit to the termination plate.
3. Wait until the status of this new backup is up and running as indicated by the DUAL LED on both the Primary and the Backup CI869.
4. Remove the primary CI869 unit from its termination plate. The new backup unit (inserted in Step 2) becomes the primary.
5. Insert the new CI869 unit to the termination plate.

Selecting the Station Address

The station address of AC 800M controller and the CI869 module is selected in the hardware tree in the Control Builder. See the Control Builder Online Help for details.

The station address has no relation to the order of the stations along the bus. They represent the physical address which is used to refer the specific stations.

Extending the Bus

Extending the Bus cable



It is not possible to extend a single media bus without disconnecting some nodes.

The effect of doing this is that the bus communication is disturbed during the procedure of extending the bus.

In installations with redundant cable, however, it is possible to extend the bus cables one by one. When one bus cable is unusable, the communication interfaces just use the other cable.

Changing the logical Bus length

The bus has to be restarted in order to change the logical bus length.

The following procedure describe how the logical length can be changed.

1. Reset IMPL on all stations on the bus.
2. Change the bus length on all considered stations on the bus.
3. Set IMPL on the stations one by one.

Section 5 Maintenance and Fault Tracing

This chapter describes the faults that might occur in an Advant Fieldbus 100 network, how to diagnose and trace them, and what can be done to repair them.

All faults are detected and reported by the communication interface itself. They may concern the module as a whole, or they may concern the configured DSPs only.

For each of the errors that may be reported by the communication interface, it is described what the error means, what might have caused the error, and how to repair.

Errors concerning the configured DSPs are described in [DataSet Peripheral Errors](#) on page 223.

Only errors of the type “no operation” concerning the module as a whole can cause any of the communication interfaces to stop operation completely and to light its red “FAULT” LED.

Error Detection In Advant Controller 400 Series

Not in Operation

Fatal module errors cause the communication interface to restart and to remain in error state thereafter.

The individual error indications are described below. Most of the errors indicate fatal hardware errors, requiring that the communication interface must be replaced.

The reasons why the CI520/CI522 is not in operation are:

- The CI520/CI522 data base element terminals IMPL/SERVICE are reset.
- The module is out of order.
- Several stations are using the same station number.
- The bus is not terminated correctly, for example termination is missing or the cable is broken.

- The CI520 (only capable of running on a bus configured for 2000m) is connected to a bus that is configured for 8500 meters or 15000 meters.

Restarts during Operation

This type of errors usually occurs when the communication interface is master on the Advant Fieldbus 100. Special hardware supervisions on each communication interface cause a hardware reset if more than 50% of the traffic on the Advant Fieldbus 100 was faulty or if a communication interface as master on the Advant Fieldbus 100 network receives data that was not sent by itself (that is, by an other communication interface being master on the same bus).

This type of error is likely to occur if:

- The bus cable is turn apart.
- Two separate busses are connected. Each bus have a bus master. When the two busses are connected to one bus there are two bus masters on the same bus. This leads to that one of the bus masters is error marked and restarts.
- The bus cable is not properly connected.
- No bus terminators are connected.
- Several stations have been given the same station number. The station number in the Advant Controller 400 series is specified on the CI520/CI522 data base element, in the Advant Controller 110 it is specified by the position of the thumbwheel switch on the backplane and on Advant Controller 70 and S800 I/O Station it is specified by the position of the address switches on the front panel.
- If the communication interface is defective.

If the bus cables and terminations are intact and properly fixed and the addresses are set up correctly, the user should try to replace the communication interface.

If after the restart the module remains not operational, see [Not in Operation](#) on page 203.

To restart the CI520/CI522 the IMPL and SERVICE terminals must be set. At the restart the bus is initialized, the DataSet Peripheral and EventSet are configured. The following ways to start up the CI520/CI522 can be used:

1. Set the IMPL and SERVICE flags. This leads to a start up of the CI520/CI522.
2. In case the data base is correctly defined, but the CI520/CI522 still is not operating, a rough method of starting the CI520/CI522 is to pull the module out followed by, after more than five seconds, a plug in of the module again.

If the all the diodes in the front of the CI522 is turned off and the CI522 restarted and the same happens again, it is likely that the CI522 is configured with a different bus length than the bus master currently running the bus.

This usually results in a system message that contains the system error H'8000 0000. See code -4 in [Advant Fieldbus 100 related System Messages](#) on page 206.

In Operation with Error Indications

The communication interface detects many minor errors that will cause the WARNING attribute of its data base element become set. The module will however not discontinue or interrupt its operation due to this type of error.

If the reason for the error is not found by observing the LEDs, check the following points in the listed sequence:

1. Check if the configured number of cables corresponds to the installed number, that is a bus that is configured for single also is installed with single cable and a bus that is configured for redundant cable also is installed with redundant cables.
As the data transmission on both lines is supervised it is important to configure the actually installed situation.
2. Check whether two (or more) communication interfaces in the network has been given the same hardware address (specified by the STATION terminal on the CI520/CI522 data base element). This error would cause all operational communication interface in the network to report an error. A hardware restart can also be a result of this wrong setup. It is mandatory to give the Advant Fieldbus 100 stations different addresses in order to enable proper operation of the Advant Fieldbus 100.

3. Check if the error persists on several communication interfaces. This type of error would be caused by a defective communication interface blocking some part of the communication on the Advant Fieldbus 100. The defective communication interface should be replaced.

Advant Fieldbus 100 related System Messages

The system messages, generated in the Advant Controller 400 Series, are displayed on the connected Advant Station 100 Series engineering station.

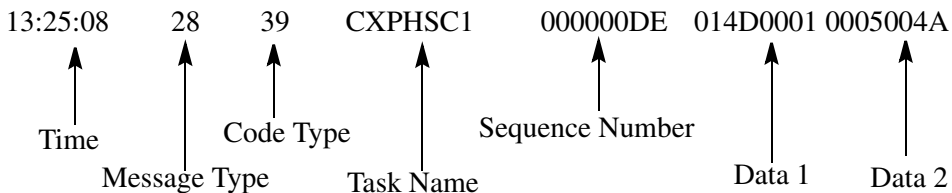

All Advant Fieldbus 100 related system messages have message *type* 28.

The *tasks* that generate Advant Fieldbus 100 related system messages are described in [Table 46](#).

Table 46. Tasks for AF 100 related system messages

	CXPIOP0	the init task.
AC 410/AC 450 * 1.1, *1.2		
	CXPC19x	the Advant Fieldbus 100 supervision task.
	CXPHSCx	the S800 I/O supervision task.
AC 410/AC 450 * 1.3 and later		
	CXPHSCx	the Advant Fieldbus 100 supervision and S800 I/O supervision task.
AC 450 * 2.0 and later		
	CXPHS10, CXPHS20	Advant Fieldbus 100 redundant CI522 Switch over tasks

In [Table 46](#), *x* is a number between 1 and 4 for Advant Controller 410 and between 1 and 8 for a Advant Controller 450.

The *sequence number* contains code specific information. If the system message is sent by CXPIOP0 or CXPHSC*x* the MSW of the sequence number field contains an internal error code.

Data1 always consists of the concept number 14D, for CI520/CI522, or 14E, for Advant Controller 110, Advant Controller 70, S800 I/O Station and Advant Fieldbus 100 Station, followed by the logical record number.

When nothing else is said, *Data2* contains logical address information.

If CXPCI9*x*/CXPHSC*x*/CXPHS*x*0 sends the system message is MSW = bus number and

LSW = station number. If CXPHSC*x* or CXPIOP0 sends the system message the first byte from the left contains bus number, the second station number, the third cluster number and the fourth byte contains module position within an S800 I/O Station.

[Table 47](#) provides a short description of the possible *code* values:

Table 47. Code values and description

Code	Description
20	Contact between system CPU and communication interface is lost.
21	Fatal hardware error. There is a fatal hardware error on the device/station.
39	Device/Station OK. The device/station is no longer erroneous.
72	Device/Station address error. The address specified in the data base is invalid.
73	Device/Station type error. The device/station type specified in the data base is invalid.
120	Access failure. An error occurred when communicating with the device/station

Table 47. Code values and description

Code	Description		
-1	Process error. The CI520/CI522 has a process error		
	<i>Data2</i> : 32-bit process error information	H'80000000	"Redundant Line failed" One of the redundant lines has failed. Check the bus cable
		H'40000000	"Simultaneous bus masters" Two or more bus masters has occurred on the bus. Check the installation.
		H'20000000	"More than 50 errors" More than 50 errors has been detected by the CI520/CI522. Check the configuration.
-4	System error. The CI520/CI522 has a system error		
	<i>Data2</i> : 32-bit system error information.	H'80000000	"Invalid bus length" The CI520/CI522 is configured for a bus length not valid on the bus. Check the bus length for the different stations on the bus.
		H'40000000	"Simultaneous Time Masters" Several stations on the bus are defined as Time Sync Masters. Check the Time sync definitions. The error message can also indicate disturbances on the bus. Check the installation.
		H'20000000	"Bus master Synchronization lost" The current bus master has failed. Check station numbers and the installation

Table 47. Code values and description

Code	Description	
	H'10000000	"Too many signal addresses"
	H'08000000	"Permanent sender detected"
	H'04000000	<p>"Multiple devices"</p> <p>One or more stations use the same station number as this station. Check the station number in the different stations on the bus.</p> <p>The error message can also indicate disturbances on the bus. Check the installation.</p>
	<p>Sequence Number = H'B86:</p> <p><i>Data2</i>: 32-bit redundancy object system error bits</p>	<p>H'00000004</p> <p>"Too High Station Number"</p> <p>Too high bus master station numbers are used on the bus, quick switch over times can not be guaranteed.</p> <p>When CI522 redundancy is used in an AC 410 or AC 450 a requirement is that at least two bus masters or one redundant CI522 pair is given station number 5 or lower.</p> <p>The message is displayed once at start of the redundant CI522 pair, for example at system start up.</p>
-5	Minor device/station error. The device/station has some minor error that does not make the device/station unusable.	
-6	Communication error. There is no contact with the device/station.	
-9	<p>Fatal bus error. Either Advant Fieldbus 100 cable, modem or driver error.</p> <p><i>Data2</i>: 32-bit device error diagnostics</p>	

Table 47. Code values and description

Code	Description
-10	Redundant cable break. <i>Data2</i> : MSW = Bus number. <i>Data2</i> : LSW = Cable number.
-11	Redundant cable OK <i>Data2</i> : MSW = Bus number. <i>Data2</i> : LSW = Cable number.

Error Detection In Advant Controller 110/160

Not in Operation

Fatal module error cause the communication interface to restart and to remain in error state thereafter. See [Table 4](#) for usage of CI630/CI631.

The individual error indications are described below. Most of the errors indicate fatal hardware errors, requiring that the communication interface must be replaced.

The reasons why the CI626/CI627/CI630/CI631 is not in operation are:

- The CI626/CI627/CI630/CI631 data base element terminal IMPL is set to zero.
- The module is out of order.
- Several stations are using the same station number.
- The station number defined in data base differs from the value defined on the thumbwheel switch.
- If the bus is not terminated, the CI626/CI627/CI630/CI631 do not work properly.
- The CI626/CI627/CI630/CI631 (only capable of running on a bus configured for 2000m) is connected to a bus that is configured for 8500 meters or 15000 meters.

Restarts during Operation

Since the communication interfaces CI520/CI522 and CI626/CI627/CI630/CI631 are based on the same bus coupler firmware, the reasons for restart of CI626/CI627/CI630/CI631 might be the same as described in [Restarts during Operation](#) on page 204.

Besides, Advant Controller 110 permanently performs background diagnosis for all modules. If the diagnosis detects an error on the CI626/CI627/CI630/CI631, the re-configuration is started in case of parameter mismatch between application software and CI626/CI627/CI630/CI631. During that action, errors described in [CI626/CI627/CI630/CI631 Status Information](#) on page 99 may occur, and other communication interfaces on the bus may be affected, too.

If the CI626/CI627 still performs restarts, a rough way of initialization can be used by pulling out the module for at least five seconds.

If after the restart the module remains not operational, see [Not in Operation](#) on page 210.

In Operation with Error Indications

As described above, the background diagnosis of AC 110 automatically detects errors on CI626/CI627 during operation and makes error messages visible in the error report which is provided by Advant Station 100 Series engineering station. A list of all possible error messages for the CI626/CI627 is shown in [CI626/CI627/CI630/CI631 Status Information](#) on page 99. Device, system and process errors are summary error messages. Detailed information, for example the reasons described below, is readable by using diagnosis tool for Advant Controller 110/160.

Device errors are in general fatal module errors which lead to restarts of the communication interface and make an exchange of the module necessary. There are no device errors defined for DSPs.

System errors are severe errors that - in contrast to device errors - do not lead to restarts of the communication interface. Process errors in general are a sign for a wrong configuration of the Advant Fieldbus 100 and do also not lead to restarts. Both, system and process errors, may refer to the communication interface itself or to DSPs, configured by the user.

The following table describes some reasons for system and process errors and actions for removing those errors. Errors referring to DSPs are explained in [Advant Controller 110/160 and Advant Controller 70](#) on page 229.

Table 48. Error Message Information

Error type	Reason	Action
system error	No time master	Define one 'MASTER' for time synchronization in the network or define no time synchronization for all slaves.
	Simultaneous time masters	There are more than one time master on the network. Only one time master is allowed.
	Wrong parameter memory / Invalid configuration table	This may occur after insertion or restart of the CI626/CI627 and disappears after configuration of the communication interface.
	Bus administrator version conflict	Check for CI625 that have enabled bus administrator functions. In networks with CI626/CI627 and CI625 only CI626/CI627 are to be bus administrators.
	Permanent sender detected	Check network for faulty CI626/CI627, which have the 'MASTER' LED permanently enabled. Exchange those modules.
process error	Redundant line failed	One of the communication lines failed. Check the lines. In case of not connected but configured redundant line, either connect this line or configure a non-redundant network at CI626/CI627 data base element.

Error Detection In Advant Controller 70

Not in Operation

PM810 cannot detect many of the errors that CI520/CI522 or CI626/CI627 detects because it is only a slave on the Advant Fieldbus 100. Moreover the communication interface of the PM810 cannot be separately restarted, if a serious error occurs. PM810 then continues execution without Advant Fieldbus 100 data transfer.

The individual error indications are described below. Most of the errors indicate fatal hardware errors, requiring that the PM810 must be replaced.

The reasons why the communication interface of the PM810 is not in operation are:

- Wrong number of cables. Single media configured and redundant used or redundant media configured and single used.
- Several stations are using the same station number.
- The station number defined in data base differs from the value defined on the address switch on the front panel of the PM810 module.
- The bus number defined in data base differs from value defined on BUSNO terminal on CI520/CI522 data base element or the bus terminal on the CI626/CI627 data base element.
- If the bus is not terminated, it will not work properly.

If the data base is correctly defined and correct address is set on PM810 a rough way to restart the module is to perform an init on the module.

If this does not help, replace the module.

In Operation with Error Indications

The background supervision of Advant Controller 70 automatically detects some errors on the communication interface of the processor module PM810 and gives a summary error message “Errors during BAP access” visible in the error report which is provided by Advant Station 100 Series engineering station. By means of the diagnosis tool, more detailed error messages are available. A list of all possible error messages for the PM810 is shown in [Table 49](#). If the Advant Controller 70 is supervised from an Advant Controller 400 Series the status information is also displayed on the DIAG terminal on the Advant Controller 70 data base element.

A list of all possible values of status messages are shown in [AF 100 Station and Advant Controller 70/110 Station Status information](#) on page 151.

Table 49. Possible Error Messages for PM810

Error type	Reason	Action
system error	Time synchronization lost	Define one 'MASTER' for time synchronization in the network or define no time synchronization for all slaves.
	Simultaneous time masters	There are more than one time master on the network. Only one time master is allowed.
	Multiple devices (address on Advant Fieldbus 100 used twice)	Check configuration of station address for multiple used numbers.
device error	Illegal Station	Check station address selected in Advant Station 100 Series engineering station and adjusted at PM810 front panel switches. Choose same values.
	BAP memory corrupt	This is a hardware error. Exchange PM810.
	BAP failure	This is a hardware error. Exchange PM810.
	BAP DMA error	This is a hardware error. Exchange PM810.
	Fatal Advant Fieldbus 100 error	Check connection of Advant Fieldbus 100 cable to PM810.
process error	Redundant line failed	One of the communication lines failed. Check the lines. In case of not connected but configured redundant line, either connect this line or configure a non-redundant network at PM810 data base element, Advant Fieldbus 100 part.

Error Detection In S800 I/O Station

Not in Operation

CI810 cannot detect many of the errors that CI520/CI522 or CI626/CI627 detects because it is only a slave on the Advant Fieldbus 100. Moreover the communication interface of the CI810 cannot be separately restarted, if a serious error occurs CI810 stops and remains in error state.

The individual error indications are described below. Most of the errors indicate fatal hardware errors, requiring that the communication interface must be replaced.

The reasons why the CI810 is not in operation are:

- The CI810 data base element terminal IMPL/SERVICE is set to zero.
- The module is out of order.
- Single media configured and redundant used or redundant media configured and single used.
- Several stations are using the same station number.
- The station number defined in data base differs from the value defined on the address switch on the front panel of the CI810.
- The bus number defined in data base differs from value defined on BUSNO terminal on CI520/CI522 data base element or the bus terminal on the CI626/CI627 data base element.
- If the bus is not terminated, it will not work properly.

To restart CI810 set the IMPL terminal in the data base.

If the data base is correctly defined and correct address is set on CI810 the next step is to force a restart of the module:

1. Remove the Advant Fieldbus 100 bus cable from the CI810 for at least five seconds before setting it back again.
2. If this does not work a rough way to restart the module is to break the power. Pull out one of the power cables and put it back again.
3. If the module still don't work try to replace it with another.

In Operation with Error Indications

The background supervision of S800 I/O Station automatically detects some errors on the communication interface of the CI810. S800 I/O Stations are always supervised by Advant Controller 400 Series or Advant Controller 110 and the status messages are displayed on the DIAG terminal of the Advant Fieldbus 100s data base element, the possible values on the DIAG terminal are listed in [CI810 Status Information](#) on page 105.

Error Detection in AC 800M and CI869

Not in Operation

For details regarding the error detection in AC 800M controller and CI869, see the *AC 800M Controller Hardware and Operation (3BSE036351*)* manual.

In Operation with Error Indications

The error and warning indication for CI869 and AC 800M controller is displayed in the Unit Status tab of the corresponding hardware editor in the Control Builder.

[Table 50](#) describes the various status that appear in the Unit Status of CI869.

Table 50. Unit Status for CI869

Value	Displayed Message and its Description	Status Type	Indication	Alarm/Event	Severity
0x80000000	Internal HW error (see CI log). Set when a fatal software hardware error has been detected. See controller log and the CI log for more information.	ErrorsAndWarnings	Error	Alarm	High
0x40000000	Internal FW Error (see CI log). Set when a fatal software error has been detected. See controller log and the CI log for more information.	ErrorsAndWarnings	Error	Alarm	High
0x20000000	Error task is not responding. Set when the task supervision detects that a task is not responding. See controller log and / or CI log for more information.	ErrorsAndWarnings	Error	Alarm	High
0x00000001	BAP DMA error. The BAP fails to perform DMA access to the Traffic Memory.	ExtendedStatus	Error	Alarm	Medium
0x00000002	BAP failure. Malfunction of the BAP.	ExtendedStatus	Error	Alarm	Medium

Table 50. Unit Status for CI869

Value	Displayed Message and its Description	Status Type	Indication	Alarm/Event	Severity
0x00000004	Traffic memory corrupt. The Traffic Memory is corrupt.	ExtendedStatus	Error	Alarm	Medium
0x00000008	Redundant line A error. Bus traffic only on line 2. This is only reported if it is configured that cable redundancy should be used.	ExtendedStatus	Warning	-	-
0x00000010	Redundant line B error. Bus traffic only on line 1. This is only reported if it is configured that cable redundancy should be used.	ExtendedStatus	Warning	-	-
0x00000020	No bus traffic. No traffic at all on the AF 100 bus.	ExtendedStatus	Warning	Alarm	Low
0x00000040	Time sync lost. No time sync transmitted (slave frame) on the AF100 bus.	ExtendedStatus	Error	Alarm	Medium
0x00000080	Multiple time masters. The time sync CDP message is corrupt (Only tested if time sync mode = slave).	ExtendedStatus	Error	Alarm	Medium

Table 50. Unit Status for CI869

Value	Displayed Message and its Description	Status Type	Indication	Alarm/Event	Severity
0x00000100	Stn Status CDP not polled. No master frame for the CI869 station status CDP.	ExtendedStatus	Warning	-	-
0x00000200	Stn status CDP config err. Config error for the Station Status CDP.	ExtendedStatus	Error	Alarm	Medium
0x00000400	Stn status CDP not addressed. The Station Status CDP is not sent on the bus.	ExtendedStatus	Error	Alarm	Medium
0x00000800	Backup address is 255.	ExtendedStatus	Warning	-	-
0x00001000	Partner sup not active. Partner supervision is not active.	ExtendedStatus	Warning	-	-
0x00002000	Backup unreachable	ExtendedStatus	Warning	-	-
0x00004000	Invalid bus length. The CI869 is configured for a bus length not valid on the bus.	ExtendedStatus	Warning	-	-
0x00008000	Too many CDPs on the bus.	ExtendedStatus	Warning	-	-

Table 50. Unit Status for CI869

Value	Displayed Message and its Description	Status Type	Indication	Alarm/Event	Severity
0x00010000	Too many CDPs on CI869. Too many CDP has been configured on the CI869 (dependent on bus length, longer bus means less CDPs)	ExtendedStatus	Warning	-	-
0x00020000	No bus traffic on backup. There is no bus traffic through the backup CI869 module.	ExtendedStatus	Warning	Alarm	Low
0x00040000	Redundant line A error on backup. There is error in line A connected to the backup CI869	ExtendedStatus	Warning	-	-
0x00080000	Redundant line B error on backup. There is error in line B connected to the backup CI869.	ExtendedStatus	Warning	-	-
0x00100000	Permanent sender detected.	ExtendedStatus	Warning	-	-
0x00200000	Waiting for hardware initialization	ExtendedStatus	Warning	-	-
0x00800000	Incompatible version primary. Version of the Running Primary is incompatible.	ExtendedStatus	Error	Alarm	High

Table 50. Unit Status for CI869

Value	Displayed Message and its Description	Status Type	Indication	Alarm/Event	Severity
0x01000000	Incompatible version backup. Version of the Running Backup is incompatible.	ExtendedStatus	Warning	Alarm	Medium
0x02000000	Not preferred version primary. Version of the Running Primary is not preferred.	ExtendedStatus	Warning	Alarm	Medium
0x04000000	Not preferred version backup. Version of the Running Backup is not preferred	ExtendedStatus	Warning	Alarm	Medium
0x08000000	Watchdog timeout on backup.	ExtendedStatus	Warning	Alarm	Low
0x10000000	Backup device failure. The backup CI869 is not functioning properly.	ExtendedStatus	Warning	Alarm	Low
0x20000000	Switchover in progress.	ExtendedStatus	Warning	Event	Low
0x40000000	Redundant mode enabled.	ExtendedStatus	-	-	-
0x80000000	Unit B acts primary. The backup CI now acts as primary.	ExtendedStatus	-	-	-

DataSet Peripheral Errors

When the communication interface detects errors in connection with DataSet Peripheral communication, they are indicated by clearing the VALID attribute of the DataSet Peripheral element. In addition to that the ERR attribute of the communication interface is set.

In the following sections, the built in supervisions that may cause the VALID attribute to be cleared (and the ERR attribute of the module), are described.

Advant Controller 400 Series

In the Advant Controller 400 Series DSP errors are indicated with system messages and the VALID and ERR terminals on the DB element.

DataSet Peripheral not Configured

The configuration of the CI520/CI522 might fail because of several reasons, see [Table 51](#).

If the configuration of the communication interface fails new attempts to configure the DSPs are performed once every minute, unless the definition of the DSP is considered not correct or the CI520/CI522 not working.

There are several ways to restart the configuration of the communication interface. These are:

- Reset followed by set of one DSP's ACT terminal. Setting the ACT terminal leads to at most four attempts to configure the current DSP.

- Add a new DSP defined for the current bus. This leads to new attempts to configure all un-configured DSPs defined for the current bus.

Table 51. CI520/CI522 Configuration Fail Reasons

Reason	Indication	Action
<p>The DSPs are badly defined for example non existing bus or so many DSPs are defined in such way, in sense of transmission interval or number of DATs, it would result in a bus overload. This indicates that the DSPs in question cannot be configured. The error persists until the DSPs are redefined (for example with a larger cycle time or fewer DAT Elements, thus reducing the bus load).</p> <p>The DSPs are configured in groups of up to 100 elements. If one or several of these are badly defined, due to bus overload, the configuration of all DSPs in the group fails, that is even the elements that are correctly defined!</p>	<p>System message giving the first DSP, of up to 100, for which the error occurred. The DSPs are error marked. Check the DB element terminal DIAG for the cause of the error.</p>	<p>Update the definition of the DSP, set the DSP ACT terminal.</p>
<p>The communication interface is not in service.</p>	<p>System message giving the first DSP, of up to 100, for which the error occurred. The DSPs are error marked</p>	<p>Check that the IMPL/SERVICE terminals on the CI520/CI522 are set. Check that the CI520/CI522 is working and placed in the slot, defined on the data base element.</p>

Table 51. CI520/CI522 Configuration Fail Reasons (Continued)

Reason	Indication	Action
No DSPs can be configured.	System message giving the first DSP for which the error occurred. All the following DSPs defined for the current bus are error marked.	There are two ways to restart the configuration: 1. Reset followed by a set of the ACT terminal. This leads to configuration of the current DSP 2. Add a new DSP defined for the current bus. This leads to configuration of all un-configured DSPs defined for the bus.
The communication interface was busy at the time of configuration.	System message giving the first DSP, of up to 100, for which the error occurred. The DSPs are error marked.	The DSPs will automatically be configured in a later attempt after about one minute.

DataSet Peripheral not Addressed

This indicates that no bus master function for the DSP in question is detected. Either there are no bus masters, or the sending DSP has not (yet) been configured.

The error persists until the DSP in question is being addressed by the bus master.

To repair the error, make sure that the corresponding sending DSP is configured, and that

the associated communication interface is operational. When this is the case, the DSP will sooner or later be configured in the network, and the error will disappear.

DataSet Peripheral Data not Received

DataSet Peripheral data is not Received. There are four possibilities why data is not received, see [Table 52](#).

Table 52. Possibilities why Data is not Received

Reason	Indication	Action	Remarks
No data is sent to this DSP, that is the sending DSP is removed or in error state or its station is in error state.	System message giving the first DSP for which data has not been received. The VAILD terminal of concerned DSPs and of their DATs is cleared.	Find the sending DSP, check the DSP definition, the state of the communication interface and the state of the station.	
The contact with the communication interface is lost.	System message giving the first DSP for which the error occurred. The ERR and VAILD terminals of the concerned DSPs and the VALID terminal of their DATs are cleared.	Check the CI520/CI522 module and its data base.	
The CYCLETIM of one or several receiving DSPs is longer than the cycle time of the sending elements.	The VALID flag of the receiving DSP and its referenced DATs is oscillating. Not all sent data is received.	Change the CYCLETIM value so the CYCLETIM values of the sending and receiving DSPs correspond.	
The CYCLETIM value, of the receiving DSP, is shorter than the basic cycle time.	One system message at the start up of the system. The VALID flag is constantly 1, but the received data is not updated as often as specified.	Check the basic cycle time with the APP command. To change, the value, the system has to be restarted. As the very first thing change the basic cycle time with the APP command.	As the receiving data is not updated as often as specified data might be missing.

DataSet Peripheral Data not Sent

The DSP element indicates only one reason of why data is not sent, see [Table 53](#).

If DSP can update the communication interface further errors in transmission of the data is only indicated by the bus routines or at the receiving DSPs.

Table 53. DSP Element Reason why Data is not Sent

Reason	Indication	Action	Remarks
DataSet Peripheral Data not Sent. The contact with the communication interface is lost.	System message giving the first DSP for which the error occurred. The ERR and VAILD terminals of the concerned DSPs and the VALID terminal of their DATs are cleared.	Check the CI520/CI522 module and database	System message is sent for the first DSP for which the communication is broken.
Communication Overload has appeared for at least one sending DSP, the rest of the sending DSPs in the same list also fails in configuration. No indication of the error is given except that no data is received in the receiving end.	No data is received in the receiving end.	Calculate the bus load according to Bus Load Calculation on 2000 meters on page 129, and reconfigure the current DSP with a larger CYCLETIM.	No indication of Configuration Overload is given in the Advant Controller 400 Series.

DataSet Peripheral related System Messages

The system messages, generated in the Advant Controller 400 Series, are displayed on the connected Advant Station 100 Series engineering station.

13:25:08 39 1 CXAPC01 00250054 01E50005 0000811A

↑ ↑ ↑ ↑ ↑ ↑

Time Message Type Code Task Name Sequence Number Data1 Data2

All DataSet Peripheral related system messages have message *type* 39.

The *tasks* that generate DataSet Peripheral related system messages are:

- CXPIOP0, the init task.

Advant Controller 410/Advant Controller 450 *1.1:

- CXAP000, DSP task

Advant Controller 410/Advant Controller 450 *1.2 and later:

- CXAP000, DSP scan task
- CXAPC0x, DSP supervision tasks.
 x is a number between 1 and 4 for Advant Controller 410 and between 1 and 8 for Advant Controller 450.

The *sequence number* in the DSP system messages contains code specific information.

Data1 with a few exceptions consists of the concept number and the logical record number of the first DSP for which the error has occurred or the first DSP in a group of up to 100 for which the error has occurred.

Below follows a short description of an extract of the possible *code* values:

Table 54. Code values and description

Code	Description
1	Configuration error due to module busy or module hardware error <i>Data2</i> : Internal information.
3	Configuration error in configuring a group of up to 100 DSPs. <i>Data2</i> : Internal information
4	Basic cycle time used. One or several DSPs defined for a faster cycletime than the DSP scan time. <i>Data2</i> : The DSP scan time.

Table 54. Code values and description

Code	Description
5	<p>Un-configured DSPs exists.</p> <p>Un-configured DSPs exists after the configuration, they might be configured at automatic configuration. The configuration has failed or the DSPs are defined for a non-existing bus.</p> <p><i>Data2</i>: No data</p>
6	<p>Contact with the CI520/CI522 is lost.</p> <p>The CI520/CI522 is in error state or removed.</p> <p><i>Data2</i>: Reference number to DAT or no data.</p>
7	<p>Illegal bus number.</p> <p>The DSP bus number does not correspond to any bus number in use.</p> <p><i>Data2</i>: Reference number to DAT or no data.</p>

Advant Controller 110/160 and Advant Controller 70

DataSet Peripheral not Configured

This indicates that the DSP in question cannot be configured, as this would result in a bus overload. The error persists until the DSP is re-configured (for example with a larger cycle time or fewer DAT Elements, thus reducing the bus load).

The only way to resolve problems due to too high bus load is to reduce the number (or size) of the DSPs, or to make the cycle times larger.

DataSet Peripheral not Addressed

This indicates that no bus master function for the DSP in question is detected. Either there are no bus masters, or the sending DSP has not (yet) been configured.

The error persists until the DSP in question is being addressed by the bus master.

To repair the error, make sure that the corresponding sending DSP is configured, and that

the associated communication interface is operational. When this is the case, the DSP will sooner or later be configured in the network, and the error will disappear.

DataSet Peripheral not Received

This indicates that no data is received for a certain DSP, although the bus master function is active. The error persists until data is received.

The reason for this error can be found at the Advant Controller which contains the sending DSP. Probably the Advant Controller containing the sending DSP has crashed, or the sending DSP is currently not active.

AC 800M Controller and CI869

In the Control builder hardware tree with CI869, the DSPs (DSP Send and DSP Receive) are located under the hardware units *My DSP Group*, *DSP Group*, and *AF 100 Station with DSPs*.

If one or several DSPs are error marked or not transferred on the bus, the DSP device specific status is displayed in the Unit Status tab of the hardware editor in Control Builder.

[Table 55](#) provides the status indications and their description for the DSP Send or DSP Receive hardware unit.

Table 55. Unit Status indications for DSP Send and DSP Receive

Value	Displayed Message and its Description	StatusType	Indication
0x02000000	Consistent DSP transfer not updated. 32 bytes data consistency have been enabled but the Consistent DSP Transfer channel is not updated. The result in that data is not sent.	ErrorsAndWarnings	Error
0x04000000	DSP OK. The CDP is successfully sent (in case of DSP Send) or the CDP data is valid (in case of DSP Receive).	ErrorsAndWarnings	-

Table 55. Unit Status indications for DSP Send and DSP Receive

Value	Displayed Message and its Description	StatusType	Indication
0x08000000 ⁽¹⁾	Possible collision. Check-sum error on Slave Frame possible due to collision.	ErrorsAndWarnings	Error
0x10000000	Bus full. The master could not add this CDP because the bus is full. (only set if Owner = Yes)	ErrorsAndWarnings	Error
0x20000000	Owned by other station. The master could not consider this CDP because it is already in use (only set if Owner = Yes).	ErrorsAndWarnings	Error
0x40000000 ⁽¹⁾	Source no response. Master Frame but no Slave Frame for the CDP on the bus.	ErrorsAndWarnings	Error
0x80000000	Source not polled. No master frame for the CDP on the bus.	ErrorsAndWarnings	Error
0x00000001	Deleted. Deleted is the state of an unused CDP.	ExtendedStatus	-
0x00000002	Active. The CDP is fully operational.	ExtendedStatus	-
0x00000004	Passive. The CDP is configured, but not used.	ExtendedStatus	-

Table 55. Unit Status indications for DSP Send and DSP Receive

Value	Displayed Message and its Description	StatusType	Indication
0x00000010	Config running. The CDP is about to be configured at the bus master.	ExtendedStatus	-
0x00000020	Configured. Configuration with the bus master finished. Still no data transferred: written or received.	ExtendedStatus	Warning
0x00000040	Config error. The bus master has rejected the CDP.	ExtendedStatus	Error
0x00000080	DSP not active. The CDP is not Active even though two macro cycles (2*4096 ms) has been elapsed since the configuration is completed. This status is more likely to occur for DSP Receive. This status occurs because there is no owner of the DSP.	ExtendedStatus	Warning

(1) Only for DSP Receive.



If the ExtendedStatus of a DSP Receive hardware unit is in the state *Configured* or *Config Running*, or *Deleted* or *Passive*, its channel status displays the value 16#00000020 (Not Initialized).

EventSet Errors in the Advant Controller 400 Series

In the Advant Controller 400 Series errors are detected with system messages and the EVS(R) data base element ERR and WARNING terminals. EventSet uses message transfer on Advant Fieldbus 100 and therefore no configuration is performed and by this no configuration errors can appear. Errors depends on not received events, there are two possibilities why data is not received see [Table 56](#).

Table 56. Possibilities why Data is not Received

Reason	Indication	Action	Remarks
The EventSet (EVS(R)) is not receiving any events from the sending EventSet (EVS(S)) in the Advant Controller 110 node depending on a bad value on the S_USER, S_BUS and S_STATION terminals.	The EVS(R) data base element ERR terminal is set.	Check and correct the S_USER, S_BUS and S_STATION DB element terminals.	
The source EventSet does not answer, that is it is switched off, the contact with the communication interface is lost or a communication error has occurred on the used communication media.	The EVS(R) data base element WARNING terminal is set.	Find the EVS(S) element, check the EVS(S) definition, the state of the communication interface, the state of the station and the communication media.	

Appendix A Technical Data

CI520¹ Communication Interface

The CI520 communication interface is used in the Advant Controller 400 Series. The communication interface CI520 is a submodule which can handle about 4000 CDPs and have full functionality of a bus administrator, it can be a bus master on the bus.

Front Panel of the Communication Interface CI520

The front panel of the CI520 contains the ordinary green “R” (Run) LED and the red “F” (Fault) LED.

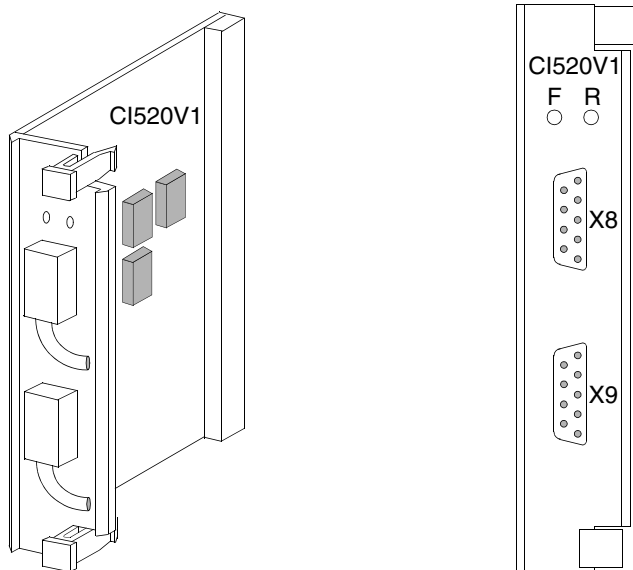

Figure 83. Front Panel of CI520V1

1. See [Table 6](#) for information about CI520 variants

CI520 Strappings

CI520 has one strapping bar X12. X12 is used for test purposes only and must not be strapped.

Technical Data of Communication Interface CI520

The communication interface CI520 is inserted into the Advant Controller 450/460 submodule carrier or in the Advant Controller 410 CPU.

Power Consumption

Power consumption of the CI520 is 3.7 W (+5V) and 2 x 2.5 W (+24V).

Connection Specifications

Bus connection X8, cable 1 and X9, cable 2 on CI520:

- Type of connector D-sub female, 9 pin
- Output voltage RS-485, GND, 24 V
- Output current max. 60mA
- Input voltage RS-485
- Input impedance type 12 kohm
- Modem cable
 - Cable number TK515 (Used for AC 450)
- Connection CI520 to TC625, TC512 or TC516
- Cable length 1.80 m (5.9 ft.)
- It is connected one-to-one
 - Remarks Right hand angled hood in CI520 end.
 - Modem cable
 - Cable number TK593 (Used for AC 410)
- Connection CI520 to TC625, TC512 or TC516

- Cable length 3.60 m (11.8 ft.)
- It is connected one-to-one
 - Remarks Right hand angled hood in CI520 end.

CI522¹ Communication Interface

The CI522 communication interface is used in the Advant Controller 400 Series. The communication interface can handle about 4000 CDPs and have full functionality of a bus administrator, it can be a bus master on the bus.

Two CI522s can form a redundant CI522 pair in which one board acts as primary while the other acts as back-up.

Front Panel of the Communication Interface CI522

The front panel of the CI522 contains four LEDs and two contacts for connection to Advant Fieldbus 100 Modems.

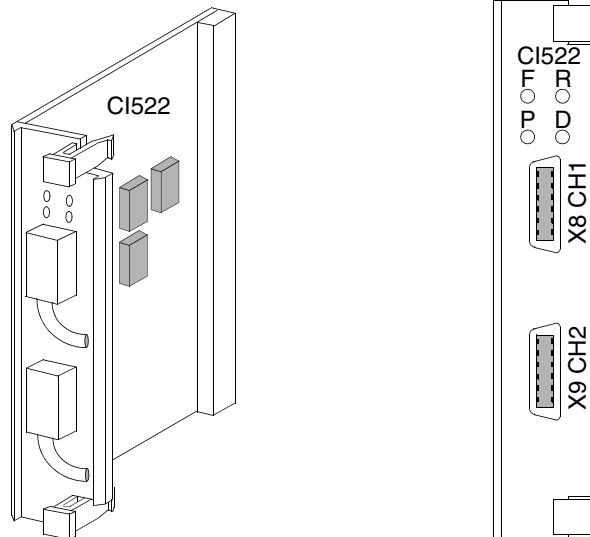

Figure 84. Front Panel of CI522

1. See [Table 6](#) for information about CI522 variants

The meaning of the LEDs is explained in the following [Table 59](#).

Table 57. Meaning of Front LEDs of CI522

LED	Indicates
R (RUN)	Green LED indicating that the CI522 is in OPERATIONAL state, i.e. executing. In case the module is configured as Bus Administrator it is now taking part in the administration of the communication on the bus.
F (FAULT)	Red LED, set when the CI522 is in FAULT state and does not take part in any communication.
P (PRIMARY)	Yellow LED, set when the module is primary in a redundant CI522 configuration.
D (DUAL)	Green LED, set in a redundant CI522 configuration when the back-up is ready to handle switch over.

Technical Data of Communication Interface CI522

The communication interface CI522 is inserted into the Advant Controller 450/460 submodule carrier or in the Advant Controller 410 CPU.

Power Consumption

Power consumption of the CI522 is 3.7 W (+5V) and 2 x 2.5 W (+24V).

Connection Specifications

Bus connection X8, cable 1 and X9, cable 2 on CI522:

- Type of connector Special female
- Output voltage RS-485, GND, 24 V
- Output current max. 60mA
- Input voltage RS-485
- Input impedance type. 12 kohms

Modem cable:

- Cable number. TK803V018 (Used for AC 450)

- Connection. CI522 to TC625/ TC512/TC516
- Cable length 1.80 m (5.9 ft.)
- It is connected one-to-one.
 - Remarks. Right hand angled hood in CI522 end.
 Modem cable:
 - Cable number. TK803V036 (Used for AC 410)
- Connection. CI522 to TC625/TC512/TC516
- Cable length 3.60 m (11.8 ft.)
- It is connected one-to-one.
 - Remarks. Right hand angled hood in CI522 end.

CI526¹ Communication Interface

The communication interface CI526 is used for connection of an AC 100 OPC Server based Personal Computer to the Advant Fieldbus 100. It can handle up to 3999 CDPs and have full functionality of a bus administrator, it can be a bus master on the bus. It is used for the PC based operator station application. CI526 has the capability to both send and receive the time synchronization signal.

Technical Data of Communication Interface CI526

The communication interface CI526 is mounted in an ISA slot in the Personal Computer.

CI526 Interface for Advant Fieldbus 100 Hardware

The Advant Fieldbus 100 Interface hardware consists of the following:

- **CI526 interface board**
The CI526 interface board fits in the IBM PC AT ISA bus and supports single or redundant bus cabling.
- **TC625/TC512/TC516 modems**

1. See [Table 6](#) for information about CI525 and CI526 variants

One or two TC625 modems (single or redundant) for Coaxial cable or, alternatively, one TC630 modem for single optical cable.

- **RA545 mounting plate**

For mounting of the modems and the power supply unit

- **SB512 power supply unit**

Power supply for the TC625/TC512/TC516 modem mounted on the same mounting plate.

- **TK549 connection cable**

A cable for connection between the CI526 board and the TC625 modem(s).

Front Panel of the Communication Interface CI526

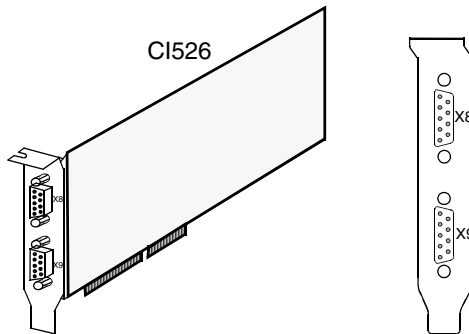

Figure 85. Front of CI526

CI526 Strappings

CI526 has four strapping bars X12, X13, S1 and S2. X12 and X13 are not strapped while S1 and S2 shall always be strapped according to the figure.

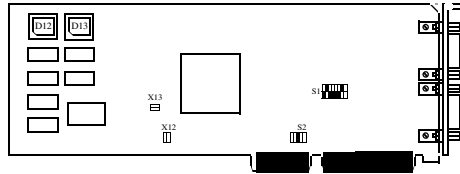

Figure 86. CI526 Strappings

Power Supply

Power consumption of the CI526 are 3.7 W (+5V).

Modem Installation

TC625 modem installation

Connect the TK549 connection cable to the CI526 interface board, the TC625 modem and the SB512 power supply unit, as shown in [Figure 83](#).

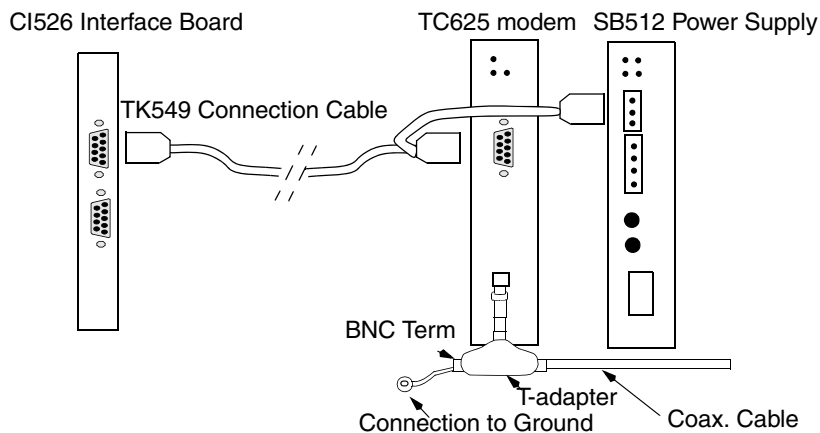

Figure CH-1. TC625 Modem Installation (Coax. Cable)

The TC625 modem is connected to the Advant Fieldbus 100 network with a BNC T-adapter.

A redundant media modem/coax. cable is mounted in a similar way to the other connector on the interface unit.

TC512/TC516 Modem Installation

Twisted pair media is connected to the interface by the TC512/TC516 modem in a similar way as the TC625 modem.

Connection Specifications

Bus connection X8, cable 1 and X9, cable 2 on CI526:

- Type of connector D-sub female, 9 pin
- Output voltage RS-485, GND
- Input voltage RS-485
- Input impedance type. 12 kohms.

Modem cable for coaxial media:

- Cable number. TK 549

- Connection. CI526 to TC625
 - Cable length 1.80 m (5.9 ft.)
 - It is connected straight through.
 - Remarks. Conn. for external 24 V power supply in the TC625 end.
- Modem cable for twisted pair media:
- Cable number. TK 515
 - Connection. CI526 to TC512/TC516
 - Cable length 1.80 m (5.9 ft.)
 - It is connected straight through
 - Remarks. Right hand angled hood in CI526 end.

CI527 Communication Interface

The communication interface CI527 is a half length PCI module which is mounted in a PCI slot in the Personal Computer. It is used in the AC 100 OPC Server. CI527 has two integrated twisted pair modems and is connected directly to the AF 100 bus.

Technical Data of Communication Interface CI527

CI527 can handle up to 3999 CDPs and have full functionality of a bus administrator which means it can be a bus master on the bus. It has the capability to both send and receive the time synchronization signal.

Front Panel of the Communication Interface CI527.

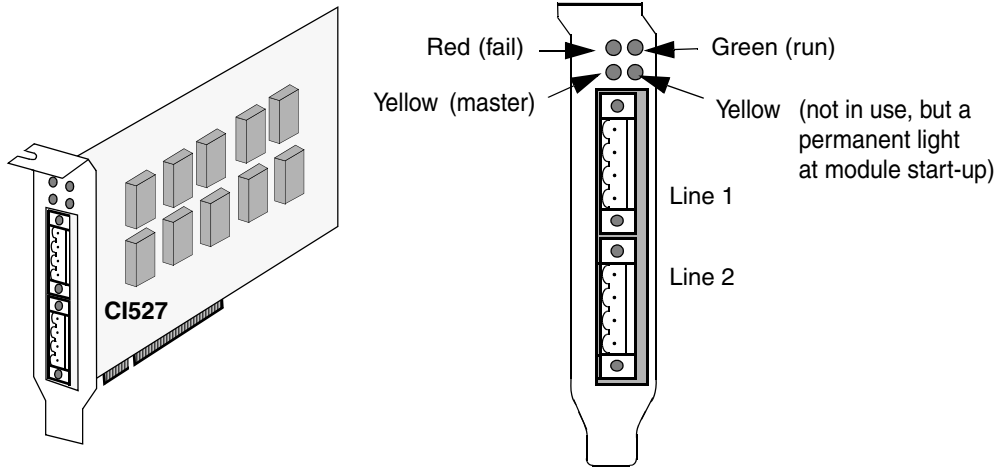

Figure 87. Front of CI527

The meaning of the LEDs is explained in the following [Table 59](#).

Table 58. Meaning of Front LEDs of CI527

LED	Indicates
RUN	Green LED indicating that the CI527 is in OPERATIONAL state, i.e. executing. In case the module is configured as Bus Administrator it is now taking part in the administration of the communication on the bus.
FAULT	Red LED, set when the CI527 is in FAULT state and does not take part in any communication.
MASTER	Yellow LED, set when the CI527 is active bus master on the Advant Fieldbus 100. For the case the CI527 module is the only master on the bus the led is set steadily. If more modules are defined as master the led is set while the module is active master, that is for one, two or four seconds depending on the CDP configuration.

CI626¹ Communication Interface

The communication interface CI626 can be used in both Advant Controller 110 and Advant Controller 160. The module has full bus administrator functionality and by this it can act as bus master on the bus.

In Advant Controller 110 the communication interface CI626 can configure up to 200 CDPs and in Advant Controller 160 it can configure up to 400 CDPs.

Technical Data of Communication Interface CI626

The communication interface CI626 is inserted into the Advant Controller 100 Series backplane, which also powers the module.

1. See [Table 6](#) for information about CI626 variants

Front Panel of the Communication Interface CI626

The front panel of the CI626 contains the ordinary green RUN LED and the red FAULT LED, as all modules. Additionally, three LEDs are used for auxiliary status information (see [Figure 88](#) below).

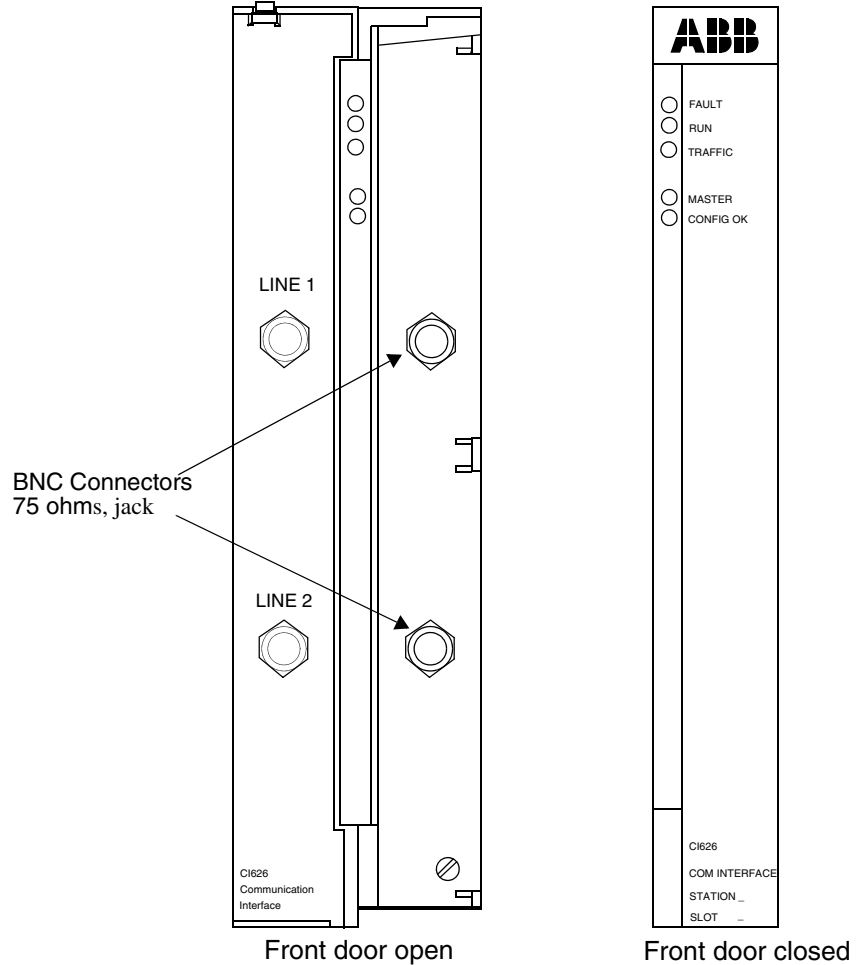

Figure 88. CI626 Front Panel

The meaning of the LEDs is explained in the following [Table 59](#).

Table 59. Meaning of Front LEDs of CI626

LED	Indicates
TRAFFIC	This green LED is set when the CI626 finds another device on the bus, or have dynamic data running without being bus master.
MASTER	This LED is set when the CI626 is bus master on the Advant Fieldbus 100. This yellow LED will be set on only one interface on the bus at any given time. Since every bus administrator passes on the master responsibilities every one, two or four seconds, this LED can be seen to migrate between all the communication interfaces in the network.
CONFIG OK	This yellow LED indicates that the CI626 has the same perception of the dynamic data configuration as the (current) master communication interface. It will thus participate in the sharing of the master responsibilities.

Power Consumption

Power consumption from the backplane voltage 24 V is 11 W.

Connection Specifications

Cable connection 1 and 2 on CI626:

- Type of connector BNC 75 ohms, jack
- Cable number TK 518 (single cable)
TK 516 (redundant cable).

CI627¹ Communication Interface

The communication interface CI627 can be used in both Advant Controller 110 and Advant Controller 160. The module has full bus administrator functionality and by this it can act as bus master on the bus.

In Advant Controller 110 the communication interface CI626 can configure up to 200 CDPs and in Advant Controller 160 it can configure up to 400 CDPs.

Technical Data of Communication Interface CI627

The communication interface CI627 is inserted into the Advant Controller 100 Series backplane, which also powers the module.

1. See [Table 6](#) for information about CI627 variants

Front Panel of the Communication Interface CI627

The front panel of the CI627 contains the ordinary green RUN LED and the red FAULT LED, as all modules. Additionally, three LEDs are used for auxiliary status information (see [Figure 89](#) below).

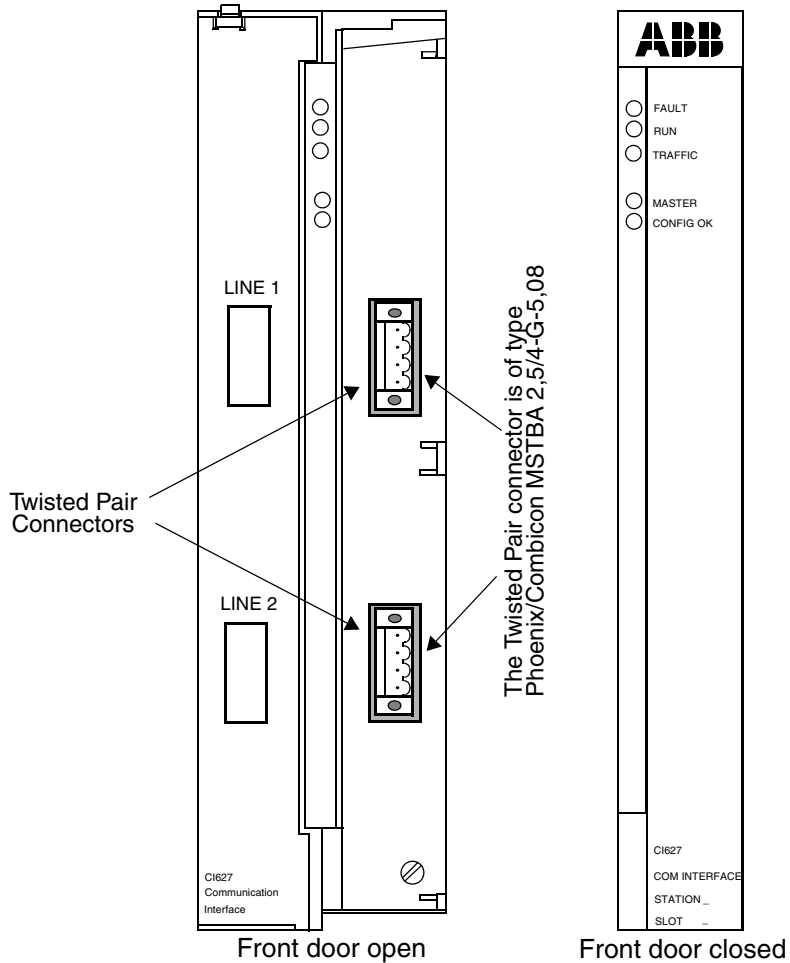

Figure 89. CI627 Front Panel

The meaning of the LEDs is explained in the following [Table 60](#).

Table 60. Meaning of Front LEDs of CI627

LED	Indicates
TRAFFIC	This green LED is set when the CI627 finds another device on the bus, or have dynamic data running without being bus master.
MASTER	This LED is set when the CI627 is bus master on the Advant Fieldbus 100. This yellow LED will be set on only one interface on the bus at any given time. Since every bus administrator passes on the master responsibilities every one, two or four seconds, this LED can be seen to migrate between all the communication interfaces in the network.
CONFIG OK	This yellow LED indicates that the CI627 has the same perception of the dynamic data configuration as the (current) master communication interface. It will thus participate in the sharing of the master responsibilities.

Power Consumption

Power consumption from the backplane voltage 24 V is 11 W.

Connection Specifications

The cable connectors in the front are of type:

- Twisted Pair connectors of type Phoenix/Combicon MSTBA 2,5/4-G-5,08.

CI630/CI631¹ Communication Interface

The communication interface CI630/CI631 can be used in Advant Controller 160. The module has full bus administrator functionality and by this it can act as bus master on the bus.

CI630/CI631 can, in Advant Controller 160, configure up to 400 CDPs.

Technical Data of Communication Interface CI630/CI631

The communication interface CI630/CI631 is inserted into the Advant Controller 160 backplane, which also powers the module.

1. See [Table 6](#) for information about CI630 and CI631 variants

Front Panel of the Communication Interface CI630

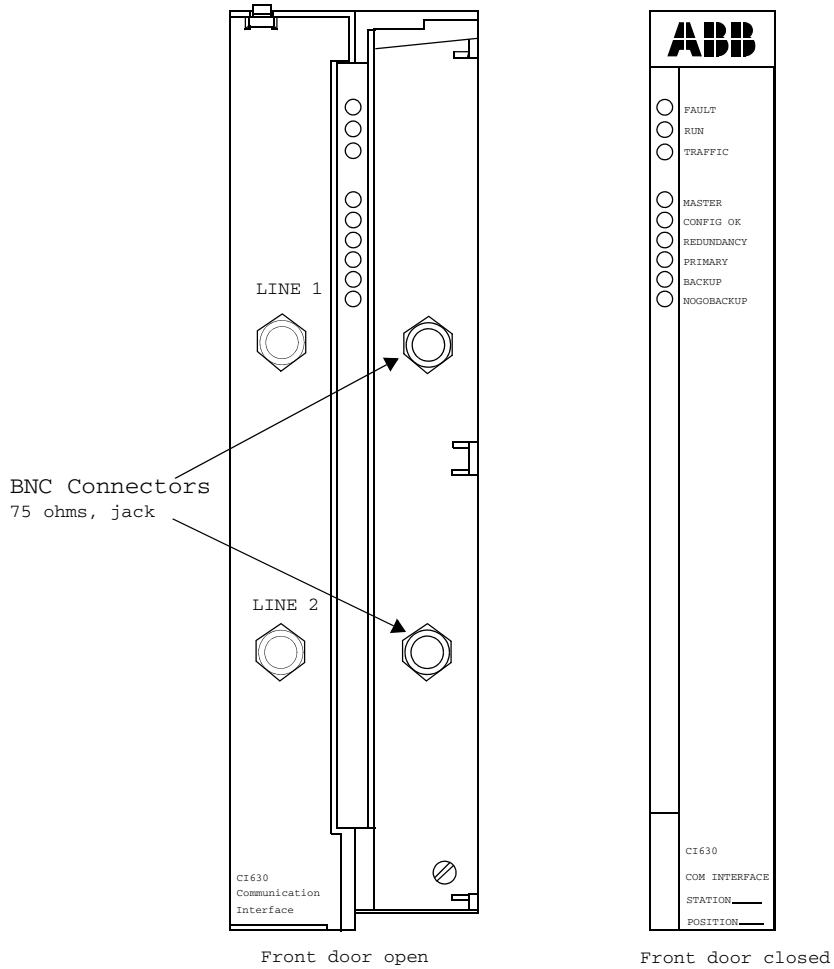

Figure 90. CI630 Front Panel

Front Panel of the Communication Interface CI631.

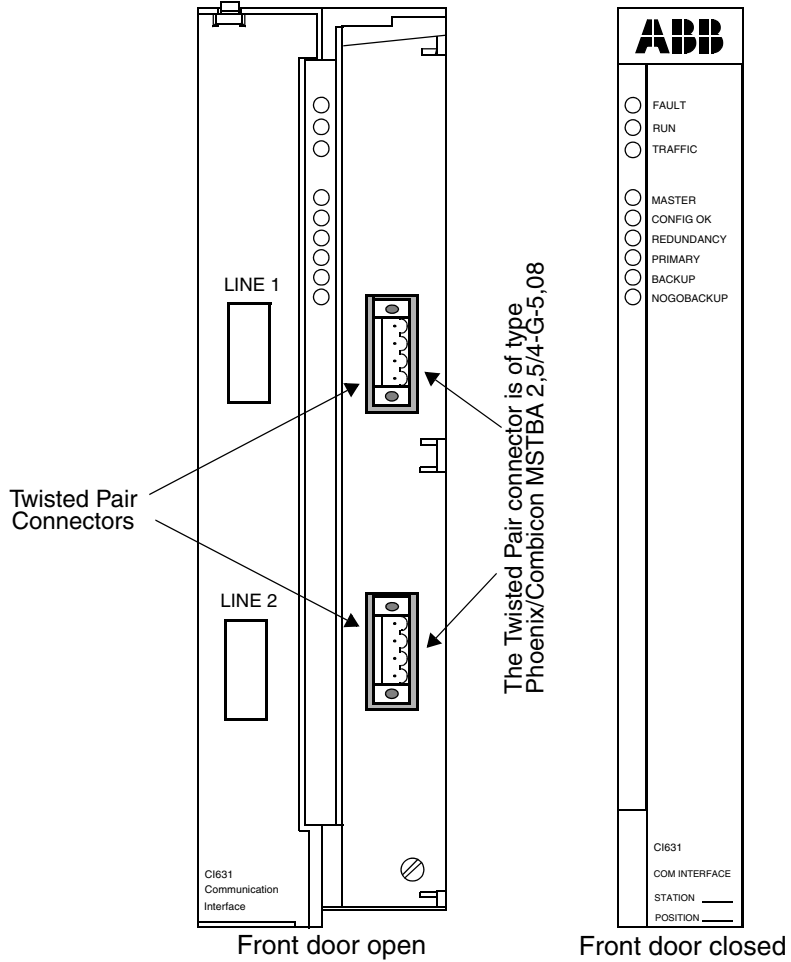

Figure 91. CI631 Front Panel

CI630/ CI631 LEDs

The front panel of the CI630 and CI631 contains the ordinary green RUN LED and the red FAULT LED, as all modules. Additionally, LEDs are used for auxiliary status information

The meaning of the LEDs is explained in the following [Table 60](#).

Table 60-1. CI630 and CI631 Front LEDs

LED	Indication
FAULT	The Communication Interface has detected a fatal hardware error and stopped communication via Advant Fieldbus 100. In this case, the meaning of all other LEDs are different from the following descriptions—they are then used for diagnostic purposes.
RUN	The Communication Interface is fully configured and operational.
TRAFFIC	If bus master: The LED indicates that the CI630/CI631 got an answer from another station on the bus. If not bus master: The LED indicates that the CI630/CI631 had been addressed by another station.
MASTER	This LED is on when the CI630/CI631 acts as bus master on the AF 100. This LED will be on at exactly one CI630/CI631 at a time in the network due to rotating bus master responsibility.
CONFIG OK	This LED indicates that the CI630/CI631 has the same perception of the data set configuration as the (current) master Communication Interface. It will therefore participate in the sharing of the master responsibilities if the MASTER function is enabled and the module is operational and synchronized.
REDUNDANCY	This LED is on when CI630/CI631 is configured as redundant.
PRIMARY	This LED indicates that the module is currently primary.

Table 60-1. CI630 and CI631 Front LEDs

LED	Indication
BACKUP	This LED indicates that the module is currently backup.
NOGOBACKUP	This LED is on when a primary module can not be forced to go to backup by the Processor Module. In case of NOGOBACKUP at the time for a switch over Advant Controller 160 will handle this by accomplishing the switch-over when the module is ready to go to Backup

Power Consumption

Power consumption from the backplane voltage 24 V is 11 W.

Connection Specifications

The type of cable connectors in the front for AF 100 are:

- For CI631: Twisted Pair connectors of type Phoenix/Combicon MSTBA 2,5/4-G-5,08.
- For CI630: BNC 75 ohms, jack

CI869 Communication Interface

For Technical Data regarding CI869, see the *AC 800M Controller Hardware and Operation (3BSE036351*)* manual.

CI810¹ Fieldbus Communications Interface (FCI)

The CI810 Fieldbus Communications Interface (FCI) is an intelligent communication interface between an Advant Controller via the Advant Fieldbus 100 and the S800 I/O modules via the MODULEBUS.

The termination board is a unit where most of the connections to the outside takes place. It is grounded to the DIN-rail through a metallic spring connector. The board carries screw terminals for power supply and redundant power supply monitoring, screw terminals for Advant Fieldbus 100 twisted-pair.

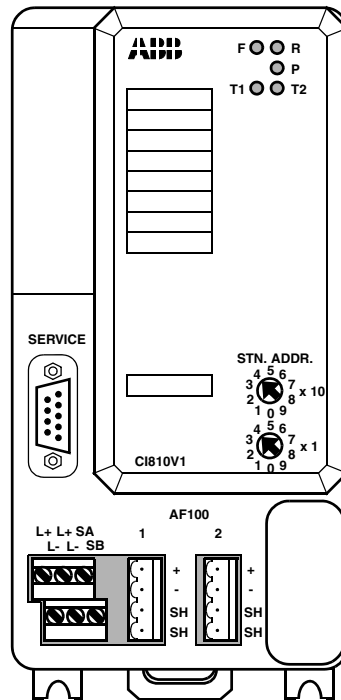

Figure 92. CI810V1 Fieldbus Communications Interface (FCI)

1. See [Table 6](#) for information about CI810 variants

Redundant S800 I/O Fieldbus Interface

The Redundant S800 I/O Interface is **build by two CI820 and one TB815**. See [Figure 21](#).

CI820 FCI Module

The CI820 Fieldbus Communications Interface (FCI) is an intelligent communication interface and a part of a Redundant S800 I/O Fieldbus Interface.

The CI820 is designed to be a part of a Redundant Fieldbus Communications Interface use together with a second CI820 connected as a unit by a Connection Unit TB815.

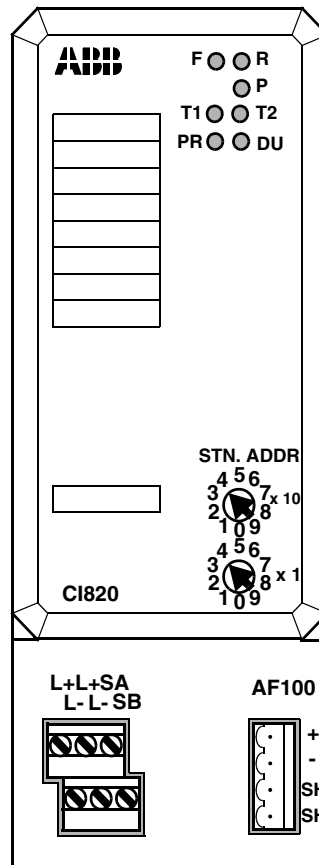

Figure 93. CI820 A Part of a Redundant Fieldbus Communication Interface (FCI)

PM810¹ Processor Module (Advant Controller 70)

The Advant Controller 70 station consists of a PM810 and S800 I/O modules mounted to a DIN-rail. It can communicate to an Advant Controller 400/110 station through a single or redundant media twisted pair Advant Fieldbus 100 (refer to [Figure 94](#)).

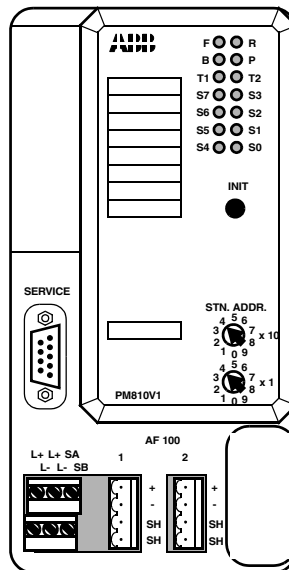

Figure 94. PM810V1 Front Panel

1. See [Table 6](#) for information about PM810 variants

Cables

Coaxial Cable

The communication interfaces CI520, CI522 and CI526 use TC625 as external modems while CI626 has integrated coaxial media modems. The modems are able to drive a 700 meter (2300 ft.) of 75 ohms coaxial cable with 80 AF 100 Stations connected.

The modems are galvanically isolated from the communication interface. The modems are HF/HV grounded through a capacitor. Furthermore, the Advant Fieldbus 100 must be grounded, but only in one end. If redundant cables are used they should be grounded in the same place (see [Section 4, Installation and Start-up](#)).

The Communication Interface CI520V1, CI522, CI526V1 and CI626V1 can handle two redundant bus cables (see [Section 4, Installation and Start-up](#)) but CI520V1, CI522, CI526V1 and CI526 must have one modem (TC625) per bus cable.

Each station connection consists of two bus cables, one drop cable and a BNC T-connection. One bus cable leading to the next communication interface, one to the previous communication interface and the drop cable leading to the actual node.

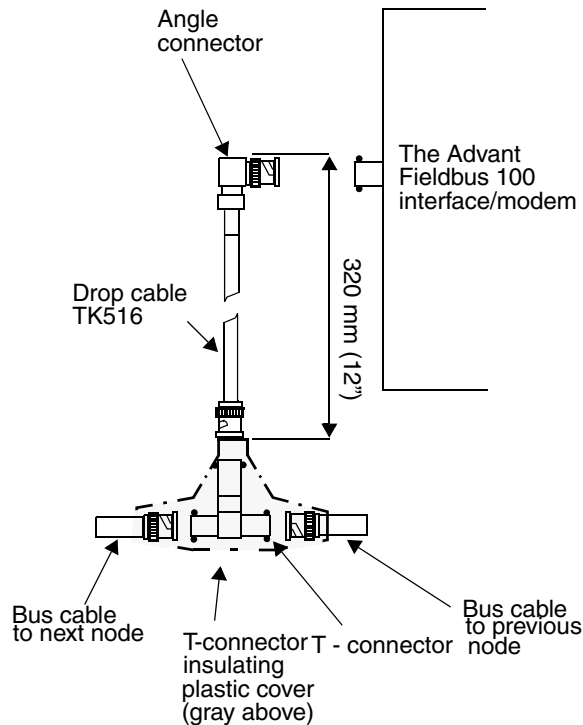

Figure 95. Drop Cable TK516 - Cable for use with Redundant Coaxial Media

These two cables are connected to a BNC T-connector (see [Figure 95](#)), which, in turn is connected through the drop cable TK516 to the BNC bus connector on the communication interface. The T-connector cover is required to isolate the BNC-connectors from all metallic connections.

Electric characteristics of the Advant Fieldbus 100 coaxial cable interface:

- Output voltage 6.3...7.3 V
- Output current max. 0.4 A
- Input voltage 4.0...7.3 V
- Input impedance typical. 50 kohm
- Test voltage 500 Vrms/1 min.

Coaxial bus cable:

- Coaxial cable 75 ohms RG59 or RG11
- Cable diameter 7 mm (RG59), or 11 mm (RG11).
- Cable length max. 300 m (1000 ft.) (RG59), 700 m (2300 ft.) (RG11)
- Maximum number of stations per segment 80
- Maximum difference in redundant cables length between any two stations on the bus. 1200 m (4000 ft.)

For connection of communication interfaces and modems to Advant Fieldbus 100 and termination of Advant Fieldbus 100 there are special connection and termination kits.

Optical Fiber

Optical bus cable:

- Optical fiber Duplex 62.5/125 μ
Multimode, graded index
 - Cable length max. 1700 m (5500 ft.)
 - Cable connector ST Style
- Maximum difference in redundant cables length between any two stations on the bus. 1200 m (4000 ft.)

Twisted Pair Cable

The communication interfaces CI520, CI522 and CI526 use TC512/TC516 as external modems for twisted pair media. CI527 uses integrated Twp modems. AC70 and S800 I/O Station contains internal modems for twisted pair media.

The modems are able to drive a 750 meter (2500 ft.) of 150 ohms twisted pair cable with 32 AF 100 Stations connected. The bus cable can be connected directly to the AF 100 Stations and modems or through a Connection unit TC505/TC506, see [Figure 96](#).

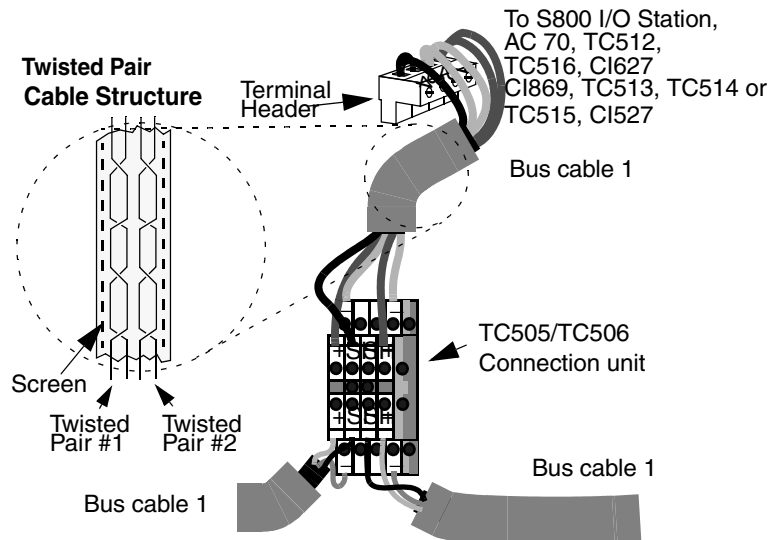

Figure 96. Installing the Bus Cable on TC505

In TC505/TC506 all shield connections (SH) are connected internally, + connections are internally connected vertically and - connections are internally connected vertically. In [Figure 97](#) a schematic picture over how the cables must be connected and the terminal connection in TC505/TC506 is shown.

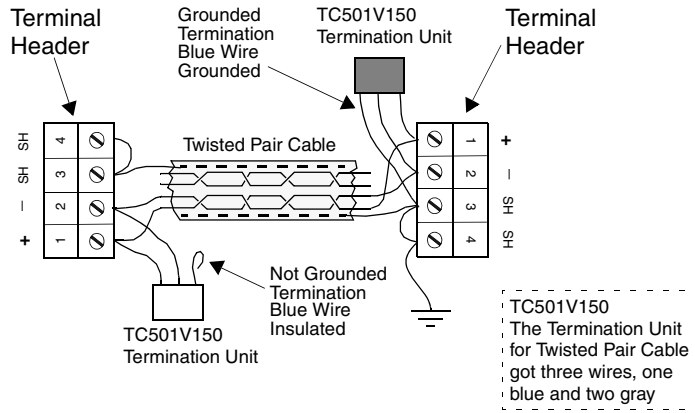

Figure 97. Schematic Image of One Twisted Pair Media Point-to-Point Connection

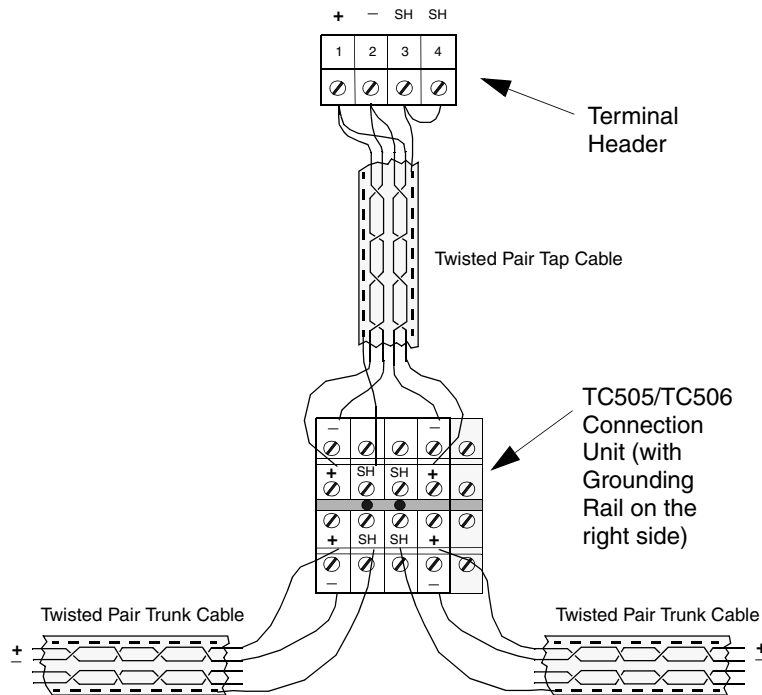

Figure 98. Schematic Image of One Twisted Pair Media Tap Connection

Electric characteristics of the Advant Fieldbus 100 twisted pair cable interface:

- Output voltage 5.5...9.0V
- Output current max. 0.2 A
- Input voltage 1.5...9.0 V
- Input impedance typ. >8 kohm

Twisted pair bus cable:

- Twisted pair cable 150 ohms
- Cable length max. 750 m (2500 ft.)
- Maximum number of stations per segment 32
- Maximum difference in redundant cables length between any two stations on the bus. 1200 m (4000 ft.)

Modems

Coaxial Cable Modem TC625

The coaxial cable modem TC625 provides a connection between the CI520, CI522 and the CI526 communication interface and the Advant Fieldbus 100 coaxial bus. It implements a transceiver/modem function for one bus. [Figure 99](#) shows a TC625. If redundant cables shall be installed, it requires two TC625. In [Figure 7](#) the principle connection with redundant cables is shown.

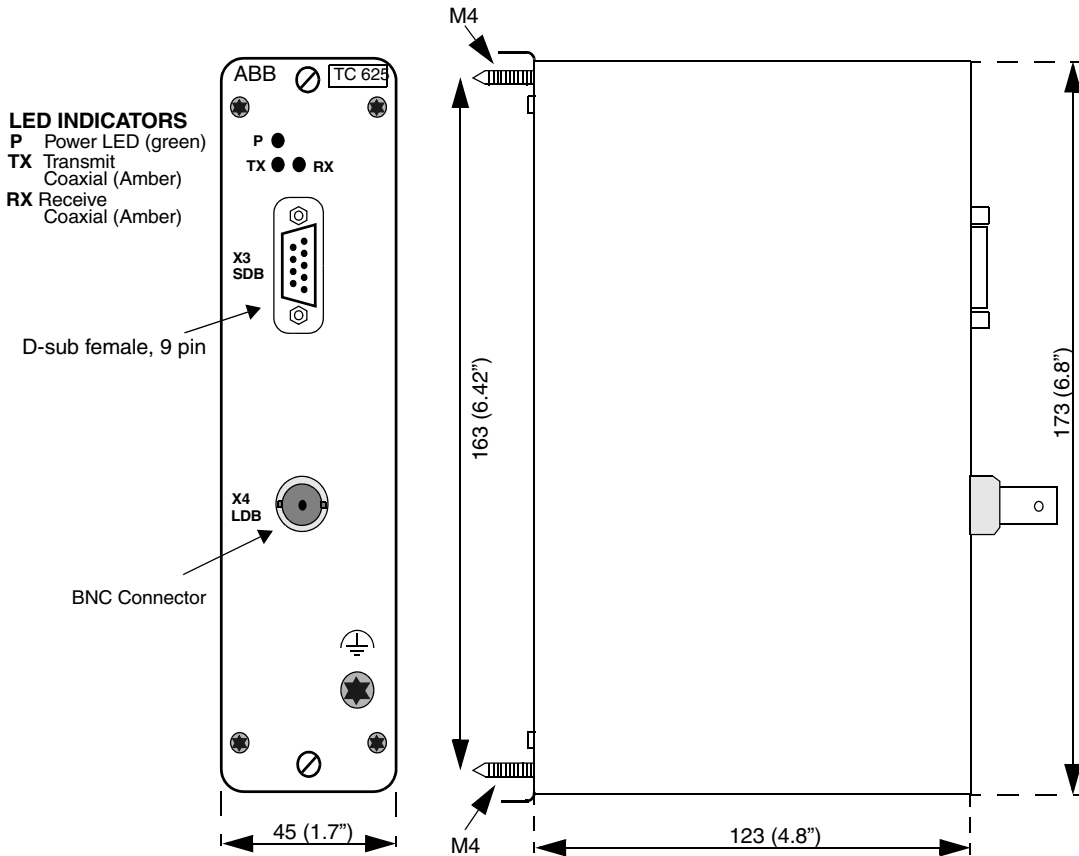

Figure 99. TC625 Coaxial Cable Modem - measurements in mm (inches)

Coaxial/Optical Modem TC630

The optical cable modem TC630 provides a point-to-point duplex optical cable connection between two Advant Fieldbus 100 coaxial networks. For the function of the bus the TC630 is total transparent. Figure 100 shows a TC630. Since it provides a point-to-point connection, it always requires two TC630 to realize a connection, see Figure 8. Each Optical Cable Modem TC630 must be calculated as 150 meters cable equivalent.

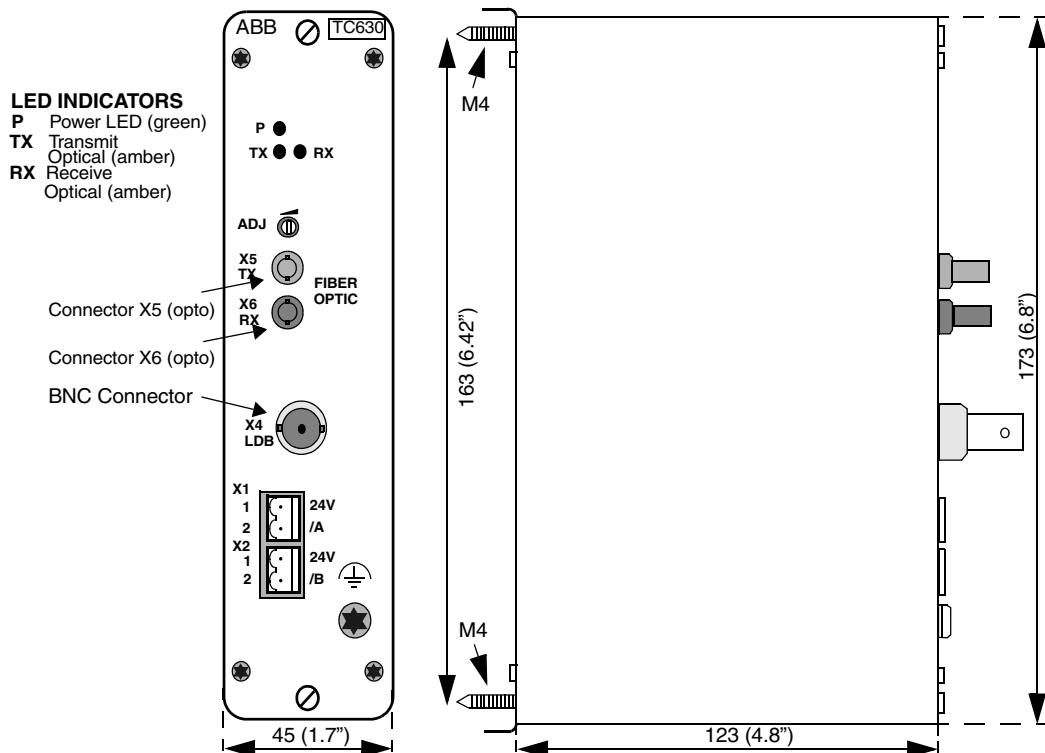

Figure 100. TC630 Opto Cable Modem - measurements in mm (inches)

The ADJustment potentiometer on the front panel is used to decrease the signal in the optical fiber. It shall normally be set to max (clockwise). If distortion occurs due to signal overload no contact between stations can be established or the contact is lost periodically. In case of distortion, attenuation can be made by screwing ADJust counter clockwise (ccw). The following approximate values give a guidance:

Number of turns (ccw)	3	5	7	9	17 to 18 (Max ccw)
Approx. Attenuation (dB)	0 to -3	-3 to -5	-5 to -6	-6 to -7	-9

Twisted Pair Modem TC512¹

The twisted pair modem TC512 provides a connection between the CI520, CI522 and the CI526 communication interface and the Advant Fieldbus 100 twisted pair bus. It implements a transceiver/modem function for one bus. [Figure 101](#) shows a TC512. If redundant cables shall be installed, two TC512 are required.

1. See [Table 6](#) for information of TC512 variants

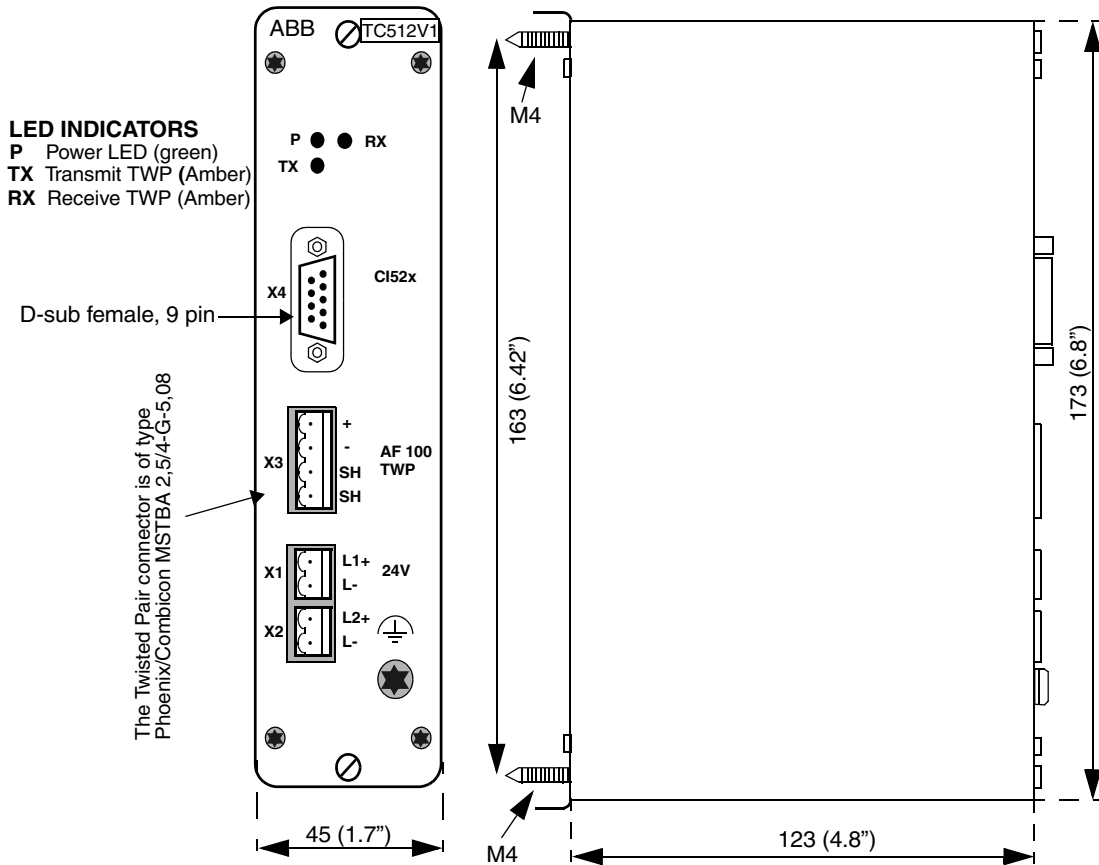

Figure 101. TC512V1 Twisted Pair Modem - measurements in mm (inches)

Twisted Pair/Coaxial Modem TC513¹

The TC513 is a modem to change media between twisted pair and coaxial media. For the function of the bus TC513 is totally transparent. The coaxial and Twisted pair media are electrically isolated from each others in the modem. One TC513 is equivalent to 150 meter (500 ft.) cable which must be noticed when calculating total bus length. If redundant cables shall be installed, it requires two TC513.

1. See [Table 6](#) for information about TC513 variants

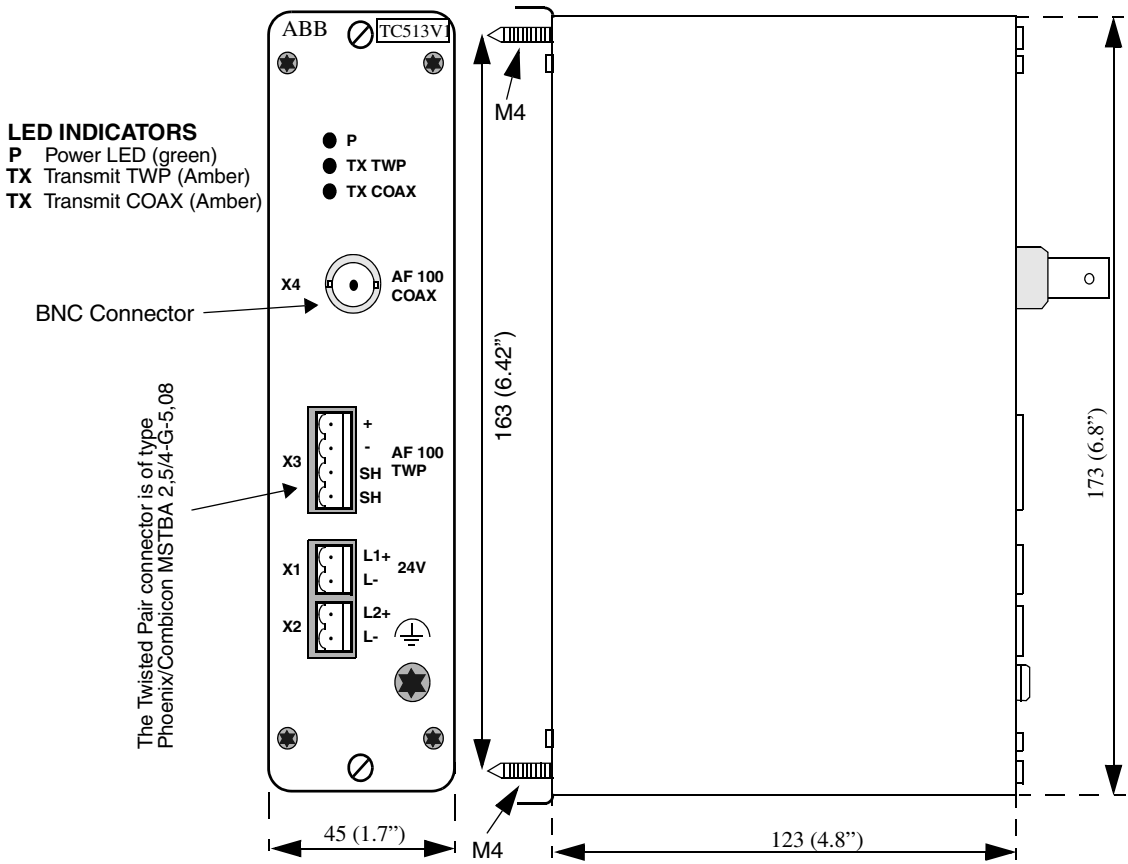

Figure 102. TC513V1 Modem Twisted Pair / Coaxial - measurements in mm (inches)

Twisted Pair/Optical Modem TC514¹

The TC514 is a modem to change media between twisted pair and optical fiber media. For the function of the bus, TC514 is totally transparent. One TC514 is equivalent to 150 meter (500 ft.) cable, which must be noticed when calculating total bus length. Protection class IP20.

1. See [Table 6](#) for information about TC514 variants

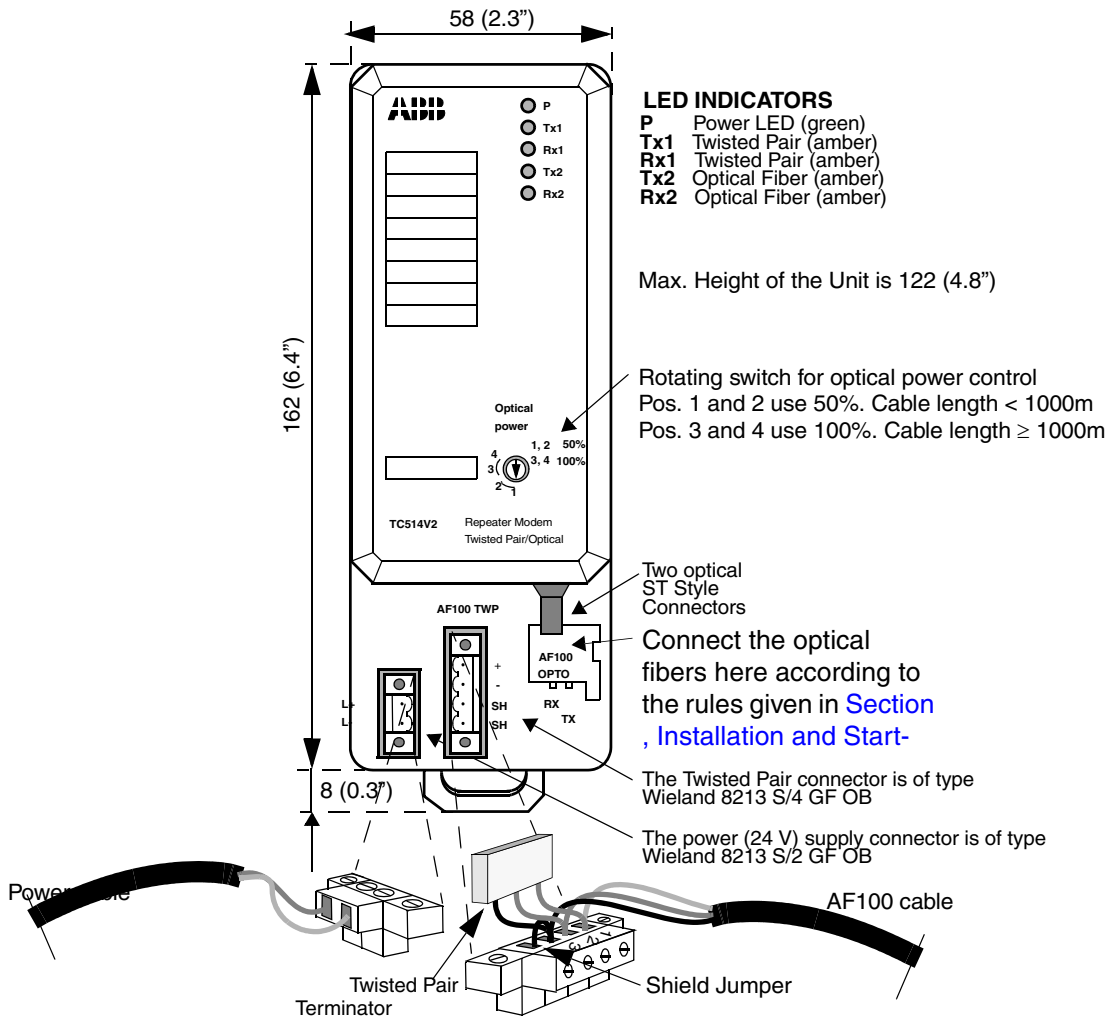

Figure 103. Twisted Pair/Optical Fiber Modem TC514V2 - measurements in mm (inches)

Mounting/Demounting of Twisted Pair/Optical Fiber Modem TC514

The Twisted Pair/Optical Fiber Modem TC514 is mounted on a DIN-rail. The DIN-rail is mounted to a metal sheet in a cabinet or on an enclosure wall with fastening screws every 100 mm, to ensure a good chassis ground connection. The modem has a snap locking device that attaches it to the mounting rail. It is possible to mount the modem both vertically and horizontally. To mount the modem, place it on the top edge of the DIN-rail, release the rail latch with a flat bad screw driver and snap the bottom mechanism into place. When the unit is in place on the DIN-rail and in vertical position, take away the screw driver and the rail latch will fix the unit in position on the DIN-rail. Release the unit from the DIN-rail in a similar way (Figure 104).

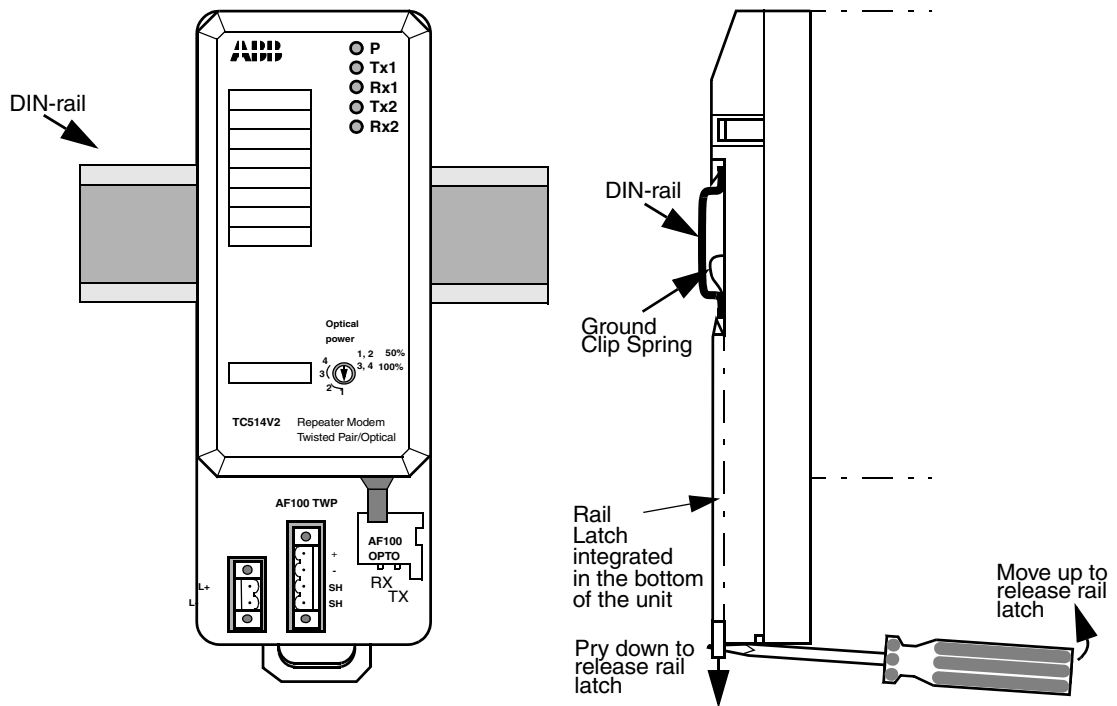

Figure 104. Mounting/Demounting the TC514 Modem Unit

Snapping the Modem to the DIN-rail makes contact by the Ground Clip Spring with the chassis.

Twisted Pair/Twisted Pair Modem TC515¹

The TC515 is a modem to expand the length of a twisted pair media part. Each section of the twisted pair media between two modems may be up to 750 meter (2500 ft.). The two Twisted pair media are electrically isolated from each others in the modem. For the function of the bus TC515 is totally transparent. One TC515 is equivalent to 150 meter (500 ft.) cable, which must be noticed when calculating total bus length. Protection class IP20.

1. See [Table 6](#) for information about TC515 variants

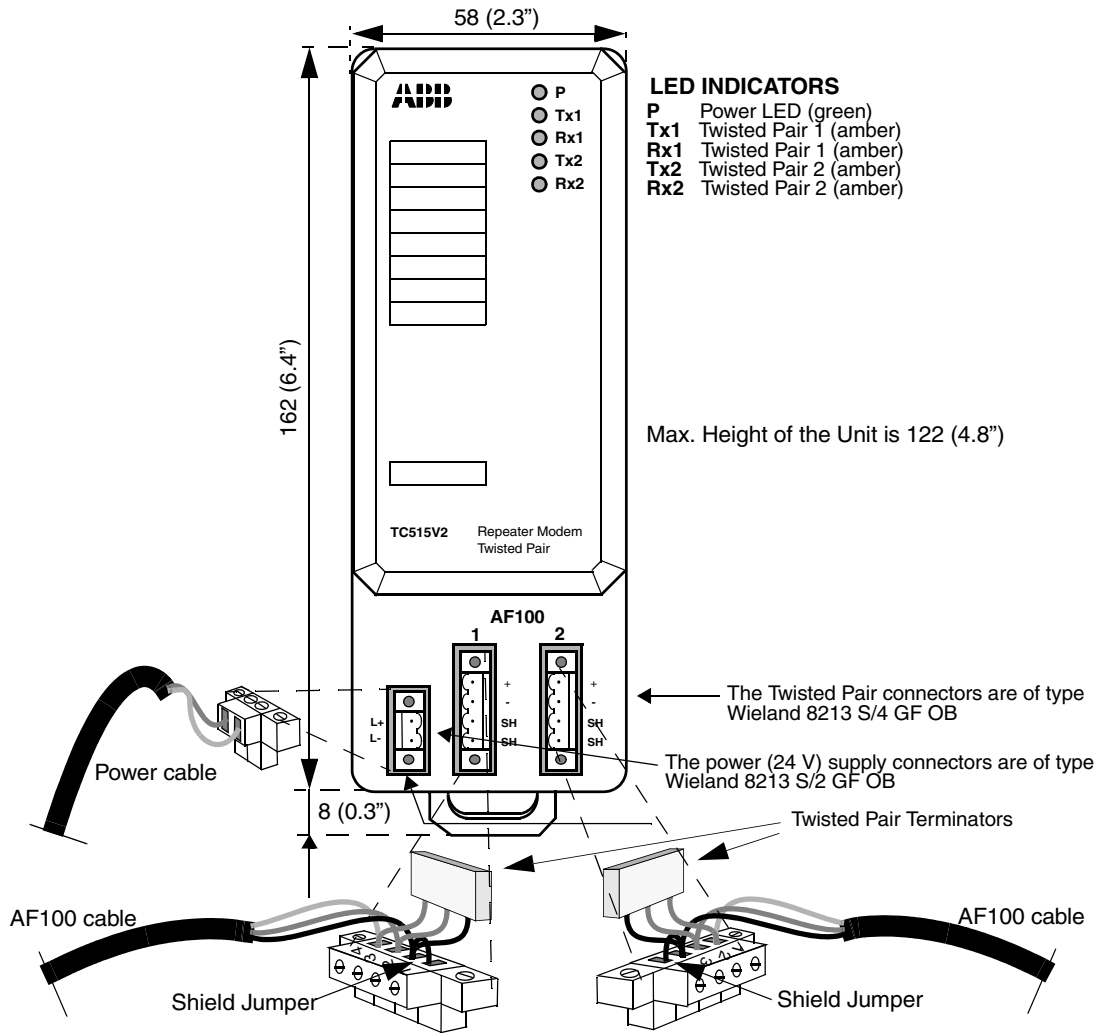

Figure 105. Twisted Pair/Twisted Pair Modem TC515V2 - measurements in mm (inches)

Mounting/Demounting the Twisted Pair/Twisted Pair Modem TC515

The Twisted Pair/Twisted Pair Modem TC515 is mounted on a DIN-rail. The DIN-rail is mounted to a metal sheet in a cabinet or on an enclosure wall with fastening screws every 100 mm, to ensure a good chassis ground connection. The modem has a snap locking device that attaches it to the mounting rail. It is possible to mount the modem both vertically and horizontally. To mount the modem, place it on the top edge of the DIN-rail, release the rail latch with a flat screw driver and snap the bottom mechanism into place. When the unit is in place on the DIN-rail and in vertical position, take away the screw driver and the rail latch will fix the unit in position on the DIN-rail. Release the unit from the DIN-rail in a similar way (Figure 106).

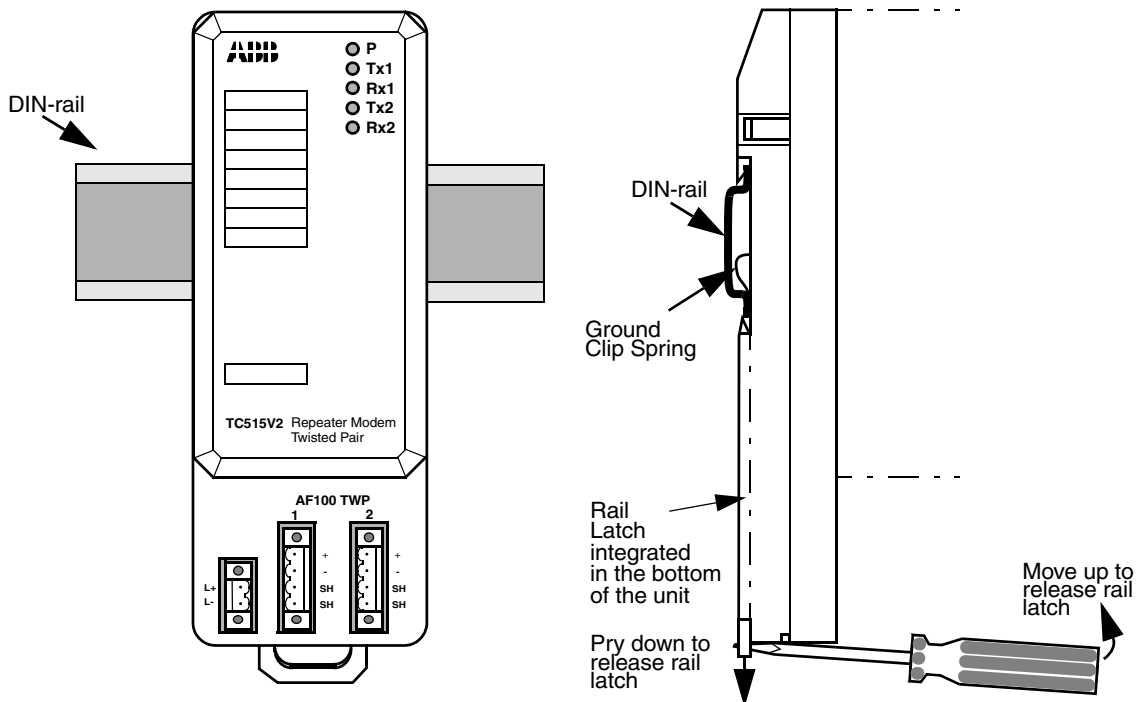

Figure 106. Mounting/Demounting the TC515 Modem Unit

Snapping the Modem to the DIN-rail makes contact by the Ground Clip Spring with the chassis.

Twisted Pair Modem TC516

The twisted pair modem TC516 is used to connect the CI522 bus coupler module to the Advant Fieldbus 100 twisted pair medium and is used when communication interface (CI522) redundancy is required. TC516 can also be used when single communication interfaces, CI520, CI522 and CI526, are used. If redundant cables shall be installed, two TC516 are required. [Figure 107](#) shows a TC516.

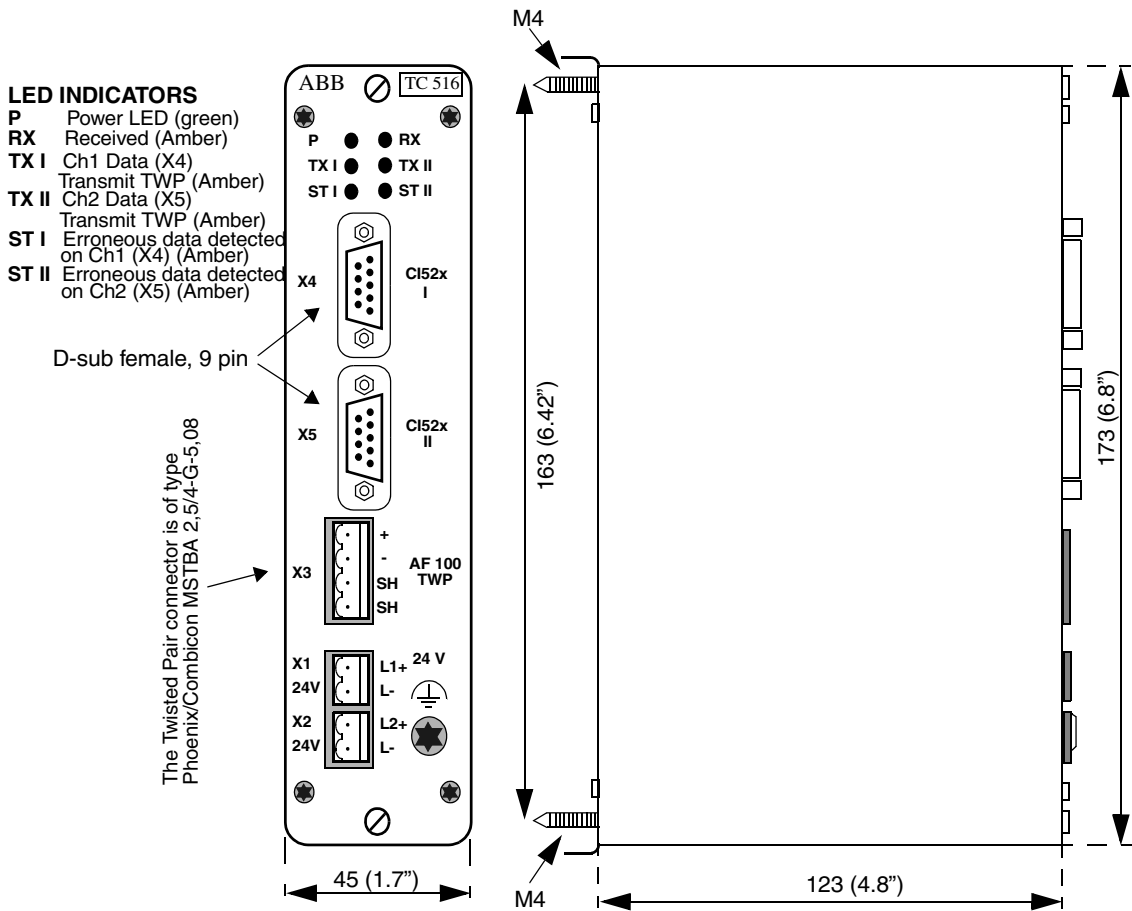

Figure 107. TC516 Twisted Pair Modem - Measurements in mm (inches)

Appendix B Low Layers of Advant Fieldbus 100

This appendix describes some technical details of the lower layers implementing the AF 100 communication. The information presented is by no means necessary to install and maintain an Advant Fieldbus 100 network. It merely completes the technical description and is intended for the curious reader only.

Basic Communication Principles

All communication on the Advant Fieldbus 100 is based on the concepts of “Master Frames” and “Slave Frames”. The bus master sends a master frame, and some other modules (or the communication interface itself) responds with a slave frame (see [Figure 108](#)).

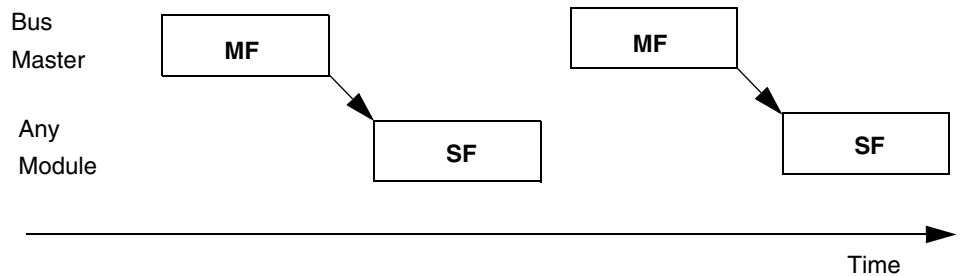

Figure 108. Master and Slave Frames

It is not required that a slave frame be sent after each master frame. Even during normal operation, it is a common event that a slave frame is missing. The master frame merely offers an opportunity to respond with a slave frame. Thus, when no bus master is present, no communication is possible at all.

Broadcast

All frames are broadcast on the Advant Fieldbus 100. This means that all attached communication interfaces are able to receive and interpret data. However, as some frames are intended for a single destination only (for example frames used for message transfer), some built-in hardware filters are available. They enable a communication interface to receive exactly the frames that it wants and not be bothered with frames destined for other communication interfaces.

Master Frames

The structure of the master frame is depicted in [Figure 109](#).

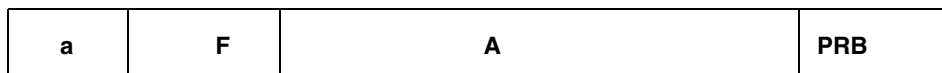

- a** Synchronization preamble (9 bits)
- F** Function code (4bits)
- A** Address/control field (12 bits)
- PRB** CRC protection byte (8 bits)

Figure 109. Master Frame

The function code determines the interpretation of the address/ control field. The function codes are categorized as depicted in [Table 61](#) below.

The individual functions, and the contents and interpretation of the address/control field, are described in the subsections below. Function codes not indicated in [Table 61](#) are currently unused.

Table 61. Function Codes

Function code	Meaning
0 - 4	Process data transfer
8	Bus Master transfer
9,13,14	Event location
12	Message transfer
15	Module status

Slave Frames

Five different slave frames of different size are defined, see [Figure 110](#).

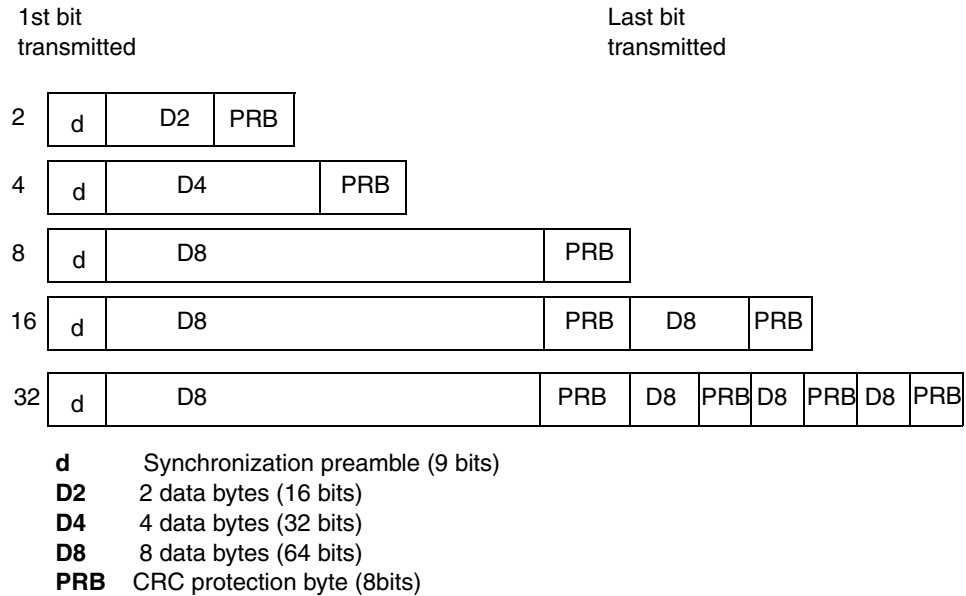

Figure 110. Slave Frames

The interpretation of the data contents in the data frames depend on the preceding master frame.

Data Security

All frames are encoded according to the Manchester II Bi-phase L Coding standard and protected by CRC protection bytes providing excellent security. The generator polynomial is:

$$G(X) = X^7 + X^6 + X^5 + X^2 + 1$$

extended with an overall even parity bit. In order to build the protection byte, all eight bits computed are inverted.

The master and slave preambles are two different bit patterns which both violate the Manchester II coding rules. They therefore pose a high security against wrong synchronization of the frames.

Process Data Transfer

Process data transfer is implemented through the concept of signal addresses. The signal address is a logical address uniquely identifying the sender of a certain process data value, corresponding to a sending DSP.

The signal addresses are assigned automatically by the Advant Station 100 Series Engineering Station from the IDENT and STATION attributes of the DSPs. The concept of signal addresses has thus been hidden from the user.

When process data transfer is attempted, the address/control field of the master frame contains the signal address identifying the process data value. The communication interface which is source for the signal address in question (that is the communication interface where the corresponding sending CDP is configured) responds with the slave frame proper (see [Figure 110](#)), containing the current data of the CDP.

The signal address also acts as a filtering mechanism. Each communication interface may define a table of signal addresses which it would like to receive. This facility is employed by the communication interface to ignore all signal addresses but those for which a receiving DSP has been defined.

The size of the slave frame depends on the function code. The correlation appears from [Table 62](#) below.

Table 62. Slave Frame size

Function code	User data in slave frame
0	2 bytes
1	4 bytes
2	8 bytes
3	16 bytes
4	32 bytes

It is important that the sender of the slave frame has the same conception of the data size as the bus master. Otherwise, it is not possible to send the slave frame. This results in a time out for the associated receiving DSPs and, eventually, the clearing of the VALID attribute (see [Defining the Communication Interface for PM810](#) on page 101). A similar problem exists on the receiving size. Size mismatches can be avoided by assuring that associated receiving DSPs and “send” have exactly the same DAT elements connected (see [Defining the Communication Interface for PM810](#) on page 101).

Message Transfer

Message transfer is sent in an event driven manner, that is only when one or more communication interfaces have something to send. The contention problems that may arise when more than one communication interface has something to send are described in [Event Location](#) on page 288.

As no slave frame can be larger than 32 bytes, messages must be divided into smaller parts, denoted packets, and assembled by the receiver. This is a higher layer protocol function, the description of which is beyond the scope of this document. Here, we shall be concerned with the transmission of packets only.

When the bus master has established that a communication interface wants to send a packet, it sends a master frame with function code 12, and the address of a communication interface in question in the address/control field. This address is the very same address configured on the thumbwheel on the Advant Controller 110 stations (see [Selecting Station Address](#) on page 192). The communication interface with the designated address responds with a 32 byte slave frame containing 2 bytes of control information and 30 bytes of user data (see below).

Bit offset

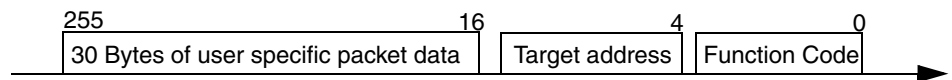

Figure 111. Packet Contents

The first two bytes of the slave frame contain the transmission mode (4 bits) and the target address (12 bits) of the frame. Several transmission modes are defined, however, the communication interface employs only the target addressing mode. This means that the frame is received by the communication interface the target address designates.

Module Status

Each communication interface connected to the Advant Fieldbus 100 supports a module status word. The status word is a two byte entity indicating whether the communication interface has a valid configuration, is able to share the bus master responsibilities, and if it wants to update the configuration of sending CDPs.

The module status is a facility which is used among the communication interfaces only. It has no significance for the CDP communication and message transfer at all.

When a communication interface is bus master, it periodically attempts reading the module status of all possible modules attached to the Advant Fieldbus 100. It thus obtains information about which communication interfaces are available, and which state they are in.

The module status is read by sending a master frame with function code 15. The address/control field contains the address of the designated communication interface. If the communication interface is present, it answers with a slave frame containing the module status word (that is two bytes of data).

Bus Master Transfer

At the end of every 1024, 2048 or 4096 millisecond cycle, time is determined by the CDP with the longest cycle time, the bus master attempts to transfer the bus master responsibilities to the next communication interface in line. The pass-over is a two-step algorithm which also includes synchronization between all communication interfaces. [Figure 112](#) shows the scenario where the bus master (with address 2) tries to transfer the bus master responsibilities to another communication interface, which is an active bus administrator (with address 3).

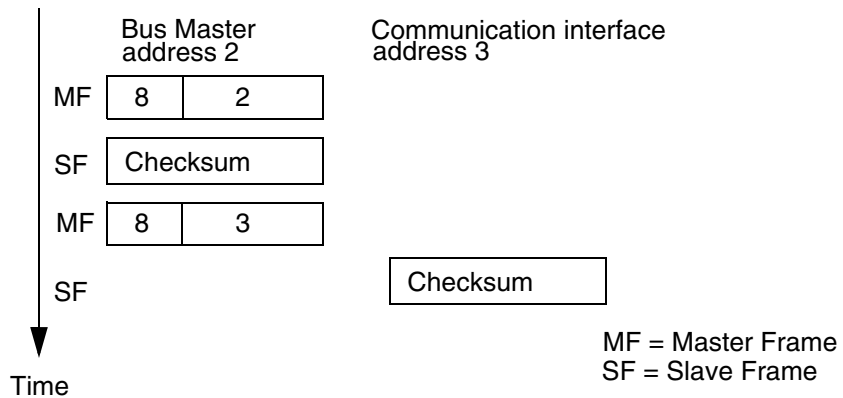

Figure 112. Bus Master Transfer

The bus master first sends a master frame with function code 8, and its own address in the address/control field. It responds itself with a two byte slave frame containing a check sum of the current configuration.

The master frame is always transmitted at a fixed time in the last time slot. The reception of this frame can thus be used for synchronization of the internal timers in all communication interfaces. Furthermore, the slave frame is used to check the validity of the configuration.

Now, the bus master sends a new master frame with function code 8 and the address of the communication interface to take over in the address/control field. This communication interface responds with a slave frame containing its own view of the current configuration (that is the check sum). If the check sum matches that of the previous slave frame, the pass-over is successful, and the new communication interface takes over the bus master responsibilities. Otherwise, the old bus master remains bus master for another 1024, 2048 or 4096 millisecond cycle.

Event Location

Message transfer is, as mentioned earlier, performed in an event driven manner. Three different master frames are available to determine which communication interfaces want to send a packet.

The event location is performed in a series of rounds. In each round, every communication interface is given the opportunity of sending a packet (see [Message Transfer](#) on page 285).

Starting a new Round

In each round, the bus master first sends a master frame with function code 9 (see [Figure 113](#)).

9	Event mode	Event type	reserved
---	------------	------------	----------

Figure 113. Event Location Master Frame

The address/control field specifies some general parameters for the event location. The event mode field (4 bits) specifies whether a new round may begin, and whether an answer is expected at all.

The event type field (4 bits) specifies the type of event (message transfer or process data). Event driven transmission of process data is currently not used in the Advant Fieldbus 100 network.

When a new round begins, all communication interfaces may answer if they want to send a packet. If more than one communication interface answers such a master frame, the result will be a collision on the bus. This situation can be detected by the bus master, however, it can not obtain the answer from any of the answering communication interfaces.

Searching for Communication Interfaces

In case of a collision the bus master now employs function code 13 and 14 to search for the communication interfaces that want to send something. Both these frames contain a pattern in the address/ control field, which only allows a part of the communication interfaces to answer.

The next master frame it sends allows only half of the communication interfaces to answer. In case of another collision, the number of communication interfaces that may answer is again halved, etc. If, during this search procedure, no answer is received, the bus master just switches to the other half and continues from there.

The event location algorithm can be depicted as a search down a binary tree.

For an example, see [Figure 114](#) below where the search tree for a configuration with 16 communication interfaces is depicted. The dots on the bottom line represent the communication interfaces. Two communication interfaces desiring to send a packet are indicated with an arrow.

At point 1 (the root of the search tree) the new round is begun. Here a collision is detected, that is at least two stations have data to send. The bus master transfers to point 2 in the tree and uses function codes 13 and 14 to search for a communication interface which wants to send a packet. Only the communication interfaces attached to the sub-tree below point 2 may answer.

Now, no answer is received, and the bus master transfers to point 3. Again, no answer is received, and the bus master transfers to point 4. Here, another collision is detected, and the communication interface transfers to point 5, where only a single answer is received.

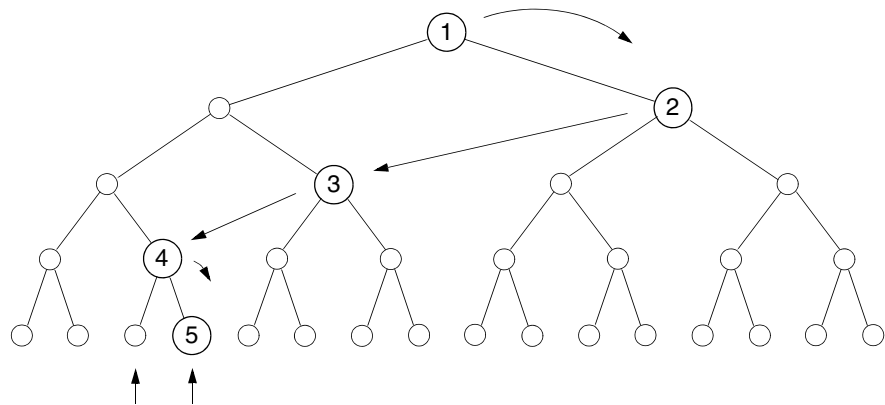

Figure 114. Event Location Procedure

Serving a Communication Interface

Eventually, only a single answer is received (a two byte slave frame). These two bytes contain a function code and an address/control field, exactly like a master frame. The slave frame constitutes a master frame which the bus master must send when possible in order to serve the communication interface that answered.

For message transfer, the two byte slave frames (to be used as master frames) will contain function code 12 and the address of the communication interface in question in the address/ control field. When the bus master sends this frame as a master frame, the other communication interface is able to transmit its packet, as described in [Message Transfer](#) on page 285.

Completing the Round

If collisions were detected during the above event location procedure, the bus master starts again from the top (using function code 9). However, this time no new round is initiated, meaning that only the communication interfaces which have not already been served may answer! This guarantees that all communication interfaces will eventually be served, and that no starvation problems occur.

When all communication interfaces have been served, the bus master starts with function code 9 again, indicating that a new round is to begin, thus allowing all communication interfaces to answer.

CDP Configuration

When a sending CDP is configured or updated, the associated communication interface engages in a configuration protocol with the other communication interfaces.

First, it requests to become bus master, as the configuration protocols require that only the bus master may distribute configuration data on the Advant Fieldbus 100. Then it distributes the configuration changes to the other communication interfaces, one by one. These, in turn, regenerate their scan tables in order to support the new configuration.

In case a communication interface, not master defined, has CDPs to be configured or updated, this is performed through a master defined communication interface.

This in turn distributes the configuration changes to the other master defined communication interfaces

When all the other communication interfaces have been updated and have generated their scan tables, the master communication interface hands over the bus master responsibilities to the next communication interface in line. From that very moment, the new configuration is in effect.

Updating Communication Interfaces

Another task performed by the current bus master communication interface is to locate communication interfaces with an invalid configuration and make sure that they are updated.

During synchronization, the individual communication interfaces may check the state of their configuration. The bus master is able to locate communication interfaces with an invalid configuration, and send a copy of the currently valid configuration to such communication interfaces.

A typical situation where a communication interface may have an invalid configuration is when an interface is exchanged. Due to the configuration protocols, however, the new communication interface will soon receive the valid configuration, and be able to participate in the sharing of the bus master responsibilities.

Contact us

www.abb.com/800xA
www.abb.com/controlsystems

Copyright© 2003-2014 ABB.
All rights reserved.

3BSE000506-600

Power and productivity
for a better world™

