



## CAT 4900

Parflex Ultra High Pressure Thermoplastic Hose,  
Fittings and Accessories 2018



ENGINEERING YOUR SUCCESS.

Extra care is taken in the preparation of this literature but Parker is not responsible for any inadvertent typographical errors or omissions. Information subject to change without notice. The information in this catalog is only accurate as of the date of publication.

For a more current information base, please consult the Parflex® Division web site at [www.parker.com/pfd](http://www.parker.com/pfd).



**FAILURE OR IMPROPER SELECTION OR IMPROPER USE OF THE PRODUCTS AND/OR SYSTEMS DESCRIBED HEREIN OR RELATED ITEMS CAN CAUSE DEATH, PERSONAL INJURY AND PROPERTY DAMAGE.**

This document and other information from Parker Hannifin Corporation, its subsidiaries and authorized distributors provide product and/or system options for further investigation by users having technical expertise. It is important that you analyze all aspects of your application and review the information concerning the product or system in the current product catalog. Due to the variety of operating conditions and applications for these products or systems, the user, through its own analysis and testing, is solely responsible for making the final selection of the products and systems and assuring that all performance, safety and warning requirements of the application are met.

The products described herein, including without limitation, product features, specifications, designs, availability and pricing, are subject to change by Parker Hannifin Corporation and its subsidiaries at any time without notice.

## **Offer of Sale**

The items described in this document are hereby offered for sale by Parker Hannifin Corporation, its subsidiaries or its authorized distributors. This offer and its acceptance are governed by the provisions stated in the "Offer of Sale".

# Welcome to The Parflex Division



Manistowoc, WI  
Ravenna, OH  
Fort Worth, TX  
Randleman, NC  
Stafford, TX  
Monterrey, MX

## Our Charter

To be the global leader in engineered polymer-based products while providing system solutions for the conveyance and control of fluids.

As part of the Parker Fluid Connectors Group, the Parflex Division is responsible for the design and manufacture of hoses and tubing to handle extreme applications. Products include thermoplastic and fluoropolymer hose and tubing, hose bundles, instrumentation tubing, harnesses and accessories.

The Parflex Division includes the Ravenna division headquarters in Ohio, and manufacturing facilities in:

- Manistowoc, WI
- Fort Worth, TX
- Stafford, TX
- Randleman, NC
- Monterrey, Mexico

# How to Use This Catalog

## **Table of Contents**

For quick, easy listing of topics covered by section, reference the Table of Contents on page 3-4.

## **Information by Part Number**

See the Part Number Index in each chapter.

## **Information by Pressure**

Reference the Pressure Selection Chart found at the beginning of the hose section in the catalog.

## **Information by Market**

Reference the market information section, beginning on page 8.

## **The Parker Part Numbering System**

The part numbering system for hose begins on page A-8. Fitting nomenclature is on page B-4.

## **International Symbols**

An explanation of the symbols and their meaning used in the product tables can be found on page 5.

# Table of Contents

## A Hose

Why Thermoplastic?.....A-4	Hose Nomenclature.....A-8
<b>polyflex</b> Hose Safety .....A-6	Hose Selection Charts.....A-12
How to Read the Hose Section.....A-7	Hoses by Series .....A-18

## B Fittings

Hose Fitting Nomenclature.....B-4	Hose Fittings by Series .....B-10
Hose Fitting Configuration Chart.....B-6	PolyflexLok .....B-74
How to Read the Fitting Section .....B-9	

## C Adapters and Valves

Part Number Nomenclature.....C-4	NPT.....C-26
Type M.....C-7	JIC .....C-43
20,000 psi - Medium Pressure .....C-11	Valves — Medium Pressure .....C-47
30,000/60,000 psi High Pressure .....C-21	Valves — High Pressure.....C-50

## D Quick Couplings

Quick Coupling Part Number Nomenclature.....D-3	
Rogan Series—30,000 psi Maximum Working Pressure.....D-5	
C Series Hydraulic Couplers—29,800 psi Maximum Working Pressure.....D-12	

## E Accessories

Heavy Duty Abrasion Cover .....E-3	Support Grips.....E-4
Heavy Duty Abrasion	Dies .....E-5
Cover Sleeves .....E-3	Warning Tags.....E-5
Spring Guards .....E-3	Pressure Containment Shield.....E-4
Bend Restrictors.....E-3	Anti-Gall Lubricant.....E-5
Containment Grips .....E-4	

continued on next page



# Table of Contents



## F General Technical



Chemical Resistance Table, Typical Waterblast and General Hydraulics .....	F-10
Chemical Resistance Table, Offshore Hoses .....	F-26
Engineering Manual (PFDE-ES28): Recommended Practices for Handling, Maintenance and Inspection of Large Bore Hoses and Assemblies Used in Oil & Gas Applications .....	F-19
Engineering Manual (PFDE-ES29): Technical Matrix for Parker <b>polyflex</b> Offshore Hoses .....	F-14
Gas Permeability of Plastics.....	F-8
Hose Dash Sizes .....	F-4
Hose Installation Tips .....	F-5
Pressure Drop - Determination of Pressure Drop in the Line .....	F-7
Recommended Tightening Procedures.....	F-9
Selection of Hose Diameter from Flow Rate and Velocity.....	F-6
Selection, Installation and Maintenance of <b>polyflex</b> Hose and Hose Assemblies.....	F-3

Safety Guide.....	F-32
Offer of Sale.....	F-39
Part Number Index .....	F-41

# Symbols

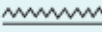
Symbol	Meaning
#	Part Number
	Hose Inner Diameter (I.D.)
	Hose Outer Diameter (O.D.)

Symbol	Meaning
	Working Pressure
	Minimum Bend Radius
	Thread Size

Symbol	Meaning
	Hex Size
	Diameter
	Weight

## ICON Identification Key

Hose markets/applications are identified using the following icons:



Oilfield Service



Waterblast



Hydraulic

# Selecting the Right Hose

## Choosing Your Hose

Before selecting hoses from Catalog 4900, it will be easier if you familiarize yourself with the basics of high pressure thermoplastic hoses. If you review the symbols on page 5 and the hose and fitting part number explanations in Sections A and B, respectively, you will have a foundation for selecting your hose. Also, the Hose Selection Charts (located at the beginning of Section A) will help pinpoint the hose you require. You can use the catalog to identify individual hoses by:

- Brief general description
- Specific size with corresponding working pressure
- Market application
- Core tube material
- Reinforcement/type of construction
- Cover material

For fittings, refer to the visual indexes in Section B.

## General Construction

Construction standards may vary between specific thermoplastic hoses.

Specific braid materials, wire reinforcements, spiral reinforcements and distinguishing features are clearly called out with each hose product. Perforated and non-perforated hoses are available based on application.

Hoses are engineered and manufactured to appropriate burst pressure to working pressure ratios according to application. Never operate a hose beyond its published working pressure.

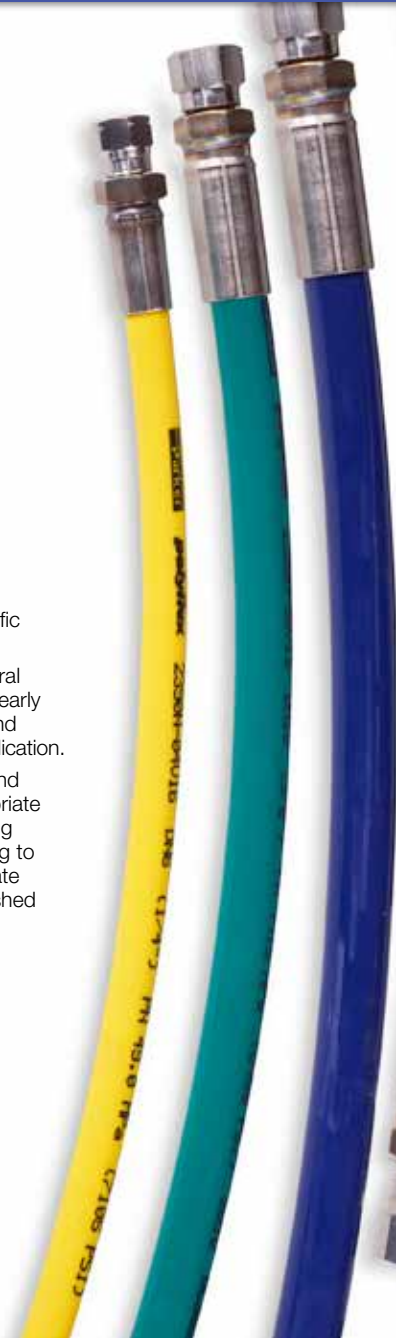





## “STAMPED”

### Size

The appropriate inside and outside diameters and length of the hose should be determined

### Temperature

The ambient and/or maximum temperature of the material being conveyed

### Application

External conditions including abrasion, climate, heat, flexing, crushing, kinking, and degrees of bending

### Media

The composition of the substance being conveyed and chemical compatibility with the hose inner core and, if applicable, the outer cover

### Pressure

The maximum pressure of the system, including pressure spikes

### Ends

The appropriate end connection and attachment method for the application

### Delivery

Testing, quality, packaging, and delivery requirements



# Waterblast / Water Jetting



Parker Parflex provides the best ultra high pressure hoses and fittings to fill the needs of the market segments that utilize water blast and water jetting technologies.

Parflex provides the power generation and refining markets with small diameter, low volumetric expansion hoses for tight routing applications, such as high pressure heat exchanger tube cleaning in petro-chemical and power plants.

**polyflex** hoses are also ideal for construction applications such as hydrodemolition, industrial cleaning and surface preparation.

**polyflex** hoses are also used in industries where water cutting is utilized — cutting through everything from chicken,

in the food processing industry, to more industrial mediums like glass and concrete.

**polyflex** hoses are the highest quality ultra high pressure thermoplastic hoses on the market. The new TOUGHJACKET™ design is sleeker and more durable than a PVC covered hose. See additional features on next page.

The water jetting icon above indicates hoses that are suitable for these applications. A visual index of these hoses is on pages 10-11.

## Applications

- Heat exchanger tube cleaning
- Water jet cutting: metal, concrete, glass, ceramics, plastics/rubber, stone
- Surface preparation
- Deburring
- Pavement Maintenance
- Tank cleaning
- Boiler cleaning
- Paint removal
- Cooling towers
- Hydrodemolition systems
- Sewer jetting
- Ship cleaning
- Rubber removal from airport runways
- Ultra high pressure food pasteurization
- Ultra high pressure water jet surgery



## Markets

- Industrial Cleaning
- Power Generation
- Chemical Refining
- Machine Tools
- Highway Maintenance
- Construction
- Marine
- Food Processing



# TOUGHJACKET™



**Built in abrasion resistance** eliminates the need for an additional PVC sleeve and lightens the hose by up to 16%.



TOUGHJACKET™ Hose

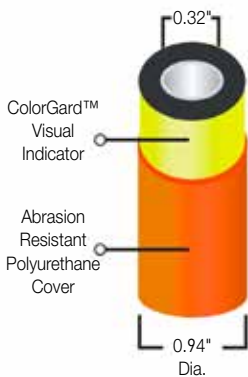



Traditional Water Blast  
Hose with PVC Cover





# Waterblast / Water Jetting





## Visual Index of Waterblast / Water Jetting Hoses

<b>2200 Series</b>	<b>2240D</b>	High pressure service for tube cleaning applications such as heat exchangers / Flexible lance	<b>2248D</b>	Tube cleaning hose
	 A-22		 A-22	



<b>2300 Series</b>	<b>2380N-...W</b>	Construction and shipbuilding industries / General industrial cleaning applications	<b>2388N-...W</b>	Construction and shipbuilding industries / General industrial cleaning applications
	 A-26		 A-30	

<b>2400 Series</b>	<b>2440D</b>	High pressure heat exchanger tube cleaning	<b>2440N</b>	Construction and shipbuilding industries / General industrial cleaning applications	<b>2448D</b>	High pressure heat exchanger tube cleaning
	 A-34		 A-36		 A-34	

<b>2500 Series</b>	<b>2580N</b>	General industrial cleaning in construction and shipbuilding industries / Hydrodemolition
	 A-40	

<b>2600 Series</b>	<b>2640D</b>	Construction and shipbuilding industries / General industrial cleaning applications	<b>2640N</b> <b>2648N</b>	Construction and shipbuilding industries / General industrial cleaning applications
	 <p>A-42</p>		 <p>A-44</p>	

<b>2700 Series</b>	<b>2740D</b> <b>2748D</b> <b>2749D</b>	Tight routing applications, such as high pressure heat exchanger tube cleaning
	 <p>A-46</p>	

<b>2800 Series</b>	<b>2840D</b> <b>2848D</b>	Water jet cutting equipment with water only or with abrasive additives / Hydroforming	<b>2849D</b>	Water jet cutting equipment with water only or with abrasive additives / Hydroforming
	 <p>A-48</p>		 <p>A-50</p>	

 <p><b>TOUGH JACKET</b><sup>TM</sup></p> <p>Available</p>	<p>2440N-08</p> <p>2740D-03</p> <p>2740D-05</p> <p>2840D-03</p> <p>2840D-05</p> <p>2849D-05</p>
--	---



The Parflex and Polyflex divisions of Parker Hannifin have been supplying a wide range of thermoplastic hose products to the oil and gas market for over 30 years.

With production plants in both the USA and Europe, supported by Parker's global sales and distribution network, customers can benefit from local service and the supply of quality parts wherever they are situated.

**polyflex** hoses can be used in a wide variety of Oil & Gas applications, both onshore and offshore, and are available with seawater resistant cover materials.

The Oil & Gas icon above indicates hoses with applications in the Oil & Gas industry, such as, umbilical and jumper hoses, BOP and hotline hoses, hydraulic control and testing hoses and large bore hoses for well servicing.

A visual index of Oil & Gas hoses can be found on pages 14-15.

## Applications

- Umbilical Hose
- BOP Stack Hose
- Oilfield Well Service
  - Cementing
  - Chemical injection
  - Well intervention
- Gas transfer
- High volume flow rate pumping offshore
- Wireline / Grease injection
- Pressure testing
- Snubbing and hydraulic workover systems
- Nitrogen pumping
- Perforating
- Well equalization lines



## Markets

- Onshore Drilling
- Offshore Drilling
- Offshore Production







## Visual Index of Oil & Gas Hoses







<b>2000 Series</b>	<b>2022N</b>	Long-length hose and hose umbilicals / Oilfield pressure control devices / Offshore oil applications
	 A-20	

<b>2300 Series</b>	<b>2380N</b>	Long-length subsea umbilical hose	<b>2388N</b>	Grease injection hose	<b>2390N</b>	Subsea hydraulic controls/Long-length hot line hose / BOP stack control lines
	 A-28		 A-30		 A-32	

<b>2400 Series</b>	<b>2440N</b>	Long-length subsea umbilical hose	<b>2448N</b>	Long-length subsea umbilical hose
	 A-38		 A-38	

<b>2600 Series</b>	<b>2640N</b>	Ultra high pressure umbilical hose
	 A-44	

<b>HP Series (See pg. A-56)</b>	<b>HP</b>	High Pressure Tools
		

<b>ChemJec</b>	<b>2440M</b>	Long-length subsea umbilical hose	<b>2448M</b>	Long-length subsea umbilical hose	<b>2640M</b>	Long-length subsea umbilical hose
	 A-68		 A-68		 A-68	



**Black  
Eagle /  
Golden  
Eagle**

<b>2240N-48V80</b>	Cementing Hose / Water and gas injection hose / Acidizing / Mud circulation	<b>2440N-48V80</b>	Cementing Hose / Water and gas injection hose / Acidizing / Mud circulation
			
A-62		A-62	
<b>2448N-32V80</b>	Cementing Hose / Water and gas injection hose / Acidizing / Mud circulation	<b>2580N-32V80</b>	Cementing Hose / Water and gas injection hose / Acidizing / Mud circulation
			
A-60		A-60	
<b>2640N-24V80</b>	Water and gas injection hose / Acidizing / Mud circulation	<b>2640N-48V80</b>	Cementing Hose / Water and gas injection hose / Acidizing / Mud circulation
			
A-58		A-62	
<b>2648N-32V80</b>	Water and gas injection hose / Acidizing / Mud circulation	<b>2240N-32V10</b> <b>2248N-32V10</b>	Cementing Hose
			
A-60		A-64	
<b>2580M-32V88</b>	Cementing Hose / Water and gas injection hose / Acidizing / Mud circulation	<b>2640M-24V88</b>	Cementing Hose / Water and gas injection hose / Acidizing / Mud circulation
			
A-66		A-66	

<b>HCR Series</b>	<b>HCR</b>	Offshore oil field exploration and production applications
		
A-52		

<b>Sea Wolf</b>	<b>57CR</b>	Offshore oil field exploration and production applications
		
A-54		

# Hydraulic



Parflex also offers a number of hoses for high pressure hydraulic applications.

**polyflex** hoses can be used to power hydraulic tools, such as torque wrenches and bolt tensioners. They are also used on rescue equipment such as the Jaws of Life and similar tools.

Hoses can be easily bonded to create twin-line and multi-line assemblies.

Other suitable hydraulic applications include test rigs and pressure testing equipment.

The hydraulic icon above indicates hoses that are suitable for hydraulic applications. A visual index of these hoses can be found on pages 18-19.

## Applications

- Rescue tools (i.e. Jaws of Life)
- Torque wrenches
- Bolt tensioners
- Pressure testing
- Power Units
- Hydraulic Jacks





## Markets



- Rescue Tools
- Hydraulic Tools
- Automotive
- Airports & Military Bases
- Engineering & Test Facilities
- Manufacturers using Hydraulic Presses
- Hydraulic Service/Repair Facilities
- Construction Equipment







## Visual Index of Hydraulic Hoses

<b>2000 Series</b>	<b>2020N</b>	Mini-hydraulic and gas applications/ Measuring and diagnostic systems	<b>2022N 10K</b>	High pressure hydraulics, pneumatics and lubricating oils / High pressure tools / Jacks / Test apparatus
	 <p>A-18</p>		 <p>A-20</p>	

<b>2300 Series</b>	<b>2380N</b>	Hydraulic controls / Test systems with synthetic and phosphate ester fluids (e.g. Skydrol)	<b>2388N</b>	Hydraulic Jacks / Bolt tensioning
	 <p>A-28</p>		 <p>A-30</p>	
	<b>2390N</b>	Pressure testing / Portable hydraulic tools / Offshore hydraulic systems	 <p>A-32</p>	

<b>2400 Series</b>	<b>2440N 2448N</b>	For use with petroleum or synthetic hydraulic fluids, gas applications and compressors
	 <p>A-38</p>	

<b>HCR Series</b>	<b>HCR</b>	Offshore oil field exploration; subsea hydraulics
	 <p>A-52</p>	



# Hose

High Pressure and  
Ultra High Pressure  
Thermoplastic



# Table of Contents

## Introduction

Why <b>polyflex</b> Thermoplastic Hose?.....	A-4
<b>polyflex</b> Hose Safety.....	A-6
How to Read the Hose Section.....	A-7
Hose Part Numbers - Nomenclature.....	A-8
Hose Assembly Part Numbers - Nomenclature.....	A-10
Hose Selection - by Working Pressure - Waterblast Hoses.....	A-12
Hose Selection - by Working Pressure - Hydraulic Hoses.....	A-14
Hose Selection - by Working Pressure - O&G Hoses.....	A-16

## **polyflex** Thermoplastic Hose

2000 Series.....	A-18
2020N.....	A-18
2022N.....	A-20
2200 Series.....	A-22
2240D/2248D.....	A-22
2300 Series.....	A-26
2380N - Waterblast Hose.....	A-26
2380N.....	A-28
2388N.....	A-30
2388N - Waterblast Hose.....	A-30
2390N.....	A-32
2400 Series.....	A-34
2440D/2448D.....	A-34
2440N - Waterblast Hose.....	A-36
2440N/2448N.....	A-38
2500 Series.....	A-40
2580N.....	A-40
2600 Series.....	A-42
2640D.....	A-42
2640N/2648N.....	A-44
2700 Series.....	A-46
2740D/2748D/2749D.....	A-46
2800 Series.....	A-48



## **polyflex** Thermoplastic Hose (continued)

2840D/2848D.....	A-48
2849D.....	A-50
57CR Series .....	A-54
HCR Series .....	A-52
<b>Black Eagle</b> .....	A-58
1-1/2" Black Eagle.....	A-58
2" Black Eagle.....	A-60
3" Black Eagle.....	A-62
Black Eagle Light .....	A-64
<b>Golden Eagle</b> .....	A-66
<b>ChemJec</b> .....	A-68

Fittings

B

Adapters & Valves

C

Quick Couplings

D

Accessories

E

General Technical

F

# Why Thermoplastic?

## Easy and Quick Installation

- ◆ Very small sizes starting with inner diameters of 2 mm (DN2 or -012). Typical disadvantages that come with using oversized hoses, such as extensive costs, waste of space, extensive weight, and complicated installation, can be avoided.
- ◆ Lightweight by design – possible weight reduction of more than 50% when compared to conventional hydraulic hoses.
- ◆ Very small outer diameters due to compact design.
- ◆ Small bend radii to save installation space.
- ◆ Long, continuous hose lengths up to 4000 meters help minimize scrap due to unusable cut-off pieces and often render connection joints unnecessary.
- ◆ Wide range of colors for easy identification of hose function and to harmonize the appearance of machine and hose.
- ◆ Easy cutting and processing, especially with textile fiber reinforced hose types.

## Outstanding Performance

- ◆ Very high working pressures up to 58,000 psi (4,000 bar).
- ◆ Reduced pressure loss due to smooth core tubes.
- ◆ Electrically conductive hoses according to SAE J517.
- ◆ Volumetric expansion according to customers needs.
- ◆ High purity of the extremely smooth core tube reduces the danger of contamination of the hydraulic system caused by deposits in the hose.
- ◆ Excellent abrasion resistance.
- ◆ High collapse pressure.
- ◆ Long shelf life.
- ◆ Individual customer hose bundles.
- ◆ Customer specific hose marking.

## Dedicated Features

- ◆ Outstanding chemical resistance
  - of hose outer cover against environmental effects
  - of hose core tube against media.
- ◆ Long service life due to excellent UV- and ozone-resistance.
- ◆ Seawater-resistant hose materials.
- ◆ Wide temperature range from -40°F (-40°C) up to 212°F (100°C) .
- ◆ Easily bond hoses together into twinline or multiline assemblies to achieve space-saving and compact units.
- ◆ Suitable for industrial gases.



Fittings

B

Adapters &amp; Valves

C

Quick Couplings

D

Accessories

E

General Technical

F

## For Your Safety

The hose assemblies listed in this catalog are all special constructions with the hose having up to eight spiral layers of steel wire. Due to this construction, pressures are achieved which far exceed international standards. These hose types are manufactured and tested according to the **polyflex** standards which have proved to be effective over many years.

**polyflex** hose assemblies are used at considerable working pressures. The critical area of a hose assembly is the connection between flexible hose and rigid fitting (crimping area). Only the use of original **polyflex** components (hose, fittings and tooling) and full compliance with the **polyflex** assembly instructions can guarantee safety and conformity with standards. It is essential that training be given to customers in the hose assembly process in order to make high quality **polyflex** maximum pressure hose assemblies.

For the production and testing of the hose assemblies relevant to the applications, the guidelines and technical regulations, as well as, the protection and hazard prevention rulings must be adhered to.

You, as the manufacturer of **polyflex** hose assemblies, are obliged to mark these hose assemblies according to the regulations and to verify their safety by a final pressure test.

Non-compliance with these rules can lead to the premature failure of the hose assembly and the loss of warranty.



- Treat high pressure hose with extreme caution. **polyflex** hoses are ultra high pressure hoses, not garden hoses, and should be treated like high pressure vessels.
- Always inspect for frayed, damaged or worn spots before using.
- Check the end connections for wear, rust, cracks or other deterioration which could produce a dangerous projectile.
- Know the working pressures and burst pressures of all hoses before using them.
- Always use clean, filtered medium to prolong hose life.
- Always clean, drain and coil hoses after use.
- Use only hoses assembled by an authorized Parker distributor.



- Never fix a hose at the sleeves.
- Never use a hose with cuts or wire showing through the outer cover.
- Never use a hose with bubbles, listers or kinks.
- Don't exceed the bend radius and pressure rating for each hose.
- Don't run over the or crush the hose with vehicles.
- Hoses with corroded or leaking end connections should be avoided.
- Avoid using dirty medium or medium with sulfur compound in it.
- Don't bend the hose over scaffolding or pull heavy equipment with the hose.
- Don't let hose support its own weight off towers or buildings.
- Never use hose without hose arrestors (containment grips).
- Don't expect water jetting or hydraulic hose to last forever.
- Don't change or repair a hose without instructions from the manufacturer.
- Never disconnect a hose under pressure.

# How to Read the Hose Section

- 1
- 2
- 3
- 4
- 5
- 6
- 7
- 8

Part Number	Jacket Color	Nominal I.D.			Maximum O.D.		Maximum Working Pressure		Minimum Bend Radius		Weight		Fitting Series
#													
		DN	inch	mm	inch	mm	psi	bar	inch	mm	lbs/ft	kg/m	
2440N-16V37	Gray	25	1	25.0	1.47	37.4	8,160	562	11.8	300	1.34	2.00	LX

NOTE: The imperial measurements are in black. The metric equivalents appear in blue.

## 1 Part Number

Hose Series Part Number - gives the construction and core tube material of the hose.

## 2 Jacket Color

Color of the hose jacket.

## 3 Inside Diameter

Distance between inner walls of the core tube.

## 4 Outside Diameter

Nominal diameter of the hose.

## 5 Working Pressure

Working pressure rating must meet or exceed the maximum operating pressure of the system including pressure spikes.

Working pressure listed is dependent on application. Water blast applications will typically have a 2.5:1 design factor. Hydraulic and Oil & Gas applications will typically have a 4:1 design factor. Contact Parflex division for detailed hose performance criteria.

## 6 Minimum Bend Radius

Minimum radius that the hose can be bent. Exceeding the bend radius can cause kinking, inner tube washout, or excessive stress on reinforcement resulting in shortened service life.

## 7 Weight

Provided in lbs/ft and kg/m.

## 8 Approved Fitting

Approved fitting series for selected hose. Technical information for fittings is provided in Section B.

# Hose Part Numbers

## Hose Part Number Build



**2440N-08V30/12**

**2440**

### 1. Reinforcement I

- 0 = No spiralizing
- 1 = Two open spiralized layers
- 2 = Two closed spiralized layers
- 3 = Two closed spiralized layers two open spiralized layers
- 4 = Four closed spiralized layers
- 5 = Four closed spiralized layers (increased pressure)
- 6 = Six closed spiralized layers
- 7 = Six closed spiralized layers (increased pressure)
- 8 = Eight closed spiralized layers
- 9 = Eight closed spiralized layers (increased pressure)

**2440**

**2440**

### 2. Reinforcement II (If Reinforcement I ≠ 0)

- 1 = Synthetic fiber (not aramid)
- 2 = Aramid fiber
- 3 = Stainless steel wire
- 4 = Steel wire
- 5 = Iron wire
- 6 = Cord strand
- 7 = Steel wire and open spiralized synthetic yarn
- 8 = Steel wire and open spiralized cord strand
- 9 = Other construction)

### 2. Reinforcement II (If Reinforcement I = 0)

- 0 = No braiding
- 1 = One braid of non-aramid fiber
- 2 = One braid of aramid fiber
- 3 = One braid of stainless steel wire
- 4 = One braid of steel wire
- 5 = One braid of iron wire
- 6 = one braid of iron wire, zinc-plated

### 3. Reinforcement III

- 0 = No braiding
- 1 = One braid of non-aramid fiber
- 2 = One braid of aramid fiber
- 3 = One braid of stainless steel wire
- 4 = One braid of steel wire
- 5 = One braid of iron wire
- 6 = One braid of iron wire, zinc-plated
- 7 = (open)
- 8 = Different pressure reinforcement

**N**

**08**

**4. Core Material**

D = POM [Delrin]  
 E = Ethylene tetrafluoroethylene (ETFE)  
 Ethylene chlorotrifluoroethylene (ECTFE)  
 F = Fluorinated ethylene propylene (FEP)  
 H =Thermoplastic Elastomer-Ether-Ester — Hytre!<sup>®\*</sup>  
 M = Mixture/co-extruded  
 N = Polyamide (Nylon)  
 P = Polyethylene (PE)  
 S = Special material  
 T = Polytetrafluoroethylene (PTFE)  
 U =Thermoplastic polyurethanes (TPU)  
 V = Polyvinylidene Fluoride (PVDF)

**5. Hose Size (I.D.)**

02 = 1/8" [3.2mm]  
 025 = 5/32" [4.0mm]  
 03 = 3/16" [4.8mm]  
 04 = 1/4" [6.4mm]  
 05 = 5/16" [7.9mm]  
 06 = 3/8" [9.5mm]  
 08 = 1/2" [12.7mm]  
 12 = 3/4" [19.0mm]  
 16 = 1" [25.4mm]  
 20 = 1-1/4" [31.8mm]  
 24 = 1-1/2" [38.1mm]  
 32 = 2" [50.8mm]  
 48 = 3" [76.0mm]

\* Registered trademark of DuPont™

**V30**

**V30**

**/12**

**/12**

**6. Cover Material**

0 = Polyurethane (PUR)  
 1 = Polyurethane (PUR)  
 -seawater-resistant  
 2 = PEE  
 3 = Polyamide (PA) -  
 Nylon (6, 11, or 12)  
 4 = Polyethylene (PE)  
 8 = Extra thick

**7. Cover Color**

0 = Black  
 1 = Black  
 (methanol-  
 washed hose  
 types)  
 2 = Blue  
 3 = Green  
 4 = Red  
 5 = Orange  
 6 = Yellow  
 7 = Gray  
 8 = Gold

**8. TOUGHJACKET  
Cover Material**

1 = Proprietary  
 Polyurethane (PUR)

**9. TOUGHJACKET  
Cover Color**

2 = Blue  
 4 = Red  
 5 = Orange  
 6 = Yellow  
 7 = Gray



Fittings

B

Adapters & Valves

C

Quick Couplings

D

Accessories

E

General Technical

F

# Hose Assembly Part Numbers

## *polyflex* Hose Assembly Nomenclature



2390N

06

01

2390N

06

01

### Hose

This series of numbers will indicate the hose base number. See pg. A-8 for detailed hose part number breakdown.

Example:  
2390N - 04V16

### Connection Type

These two digits will indicate the STYLE of connection End 1 and End 2

01	= NPT - Male
02	= NPT - Female
06	= JIC 37° Flare - Female
5Y	= Medium Pressure Female - Swivel
6A	= Code 62
6Y	= High Pressure Female - Swivel
8K	= API Hub with Flange
92	= BSP Female - Swivel
9G	= Straight Dual Seal
AY	= Type "M" Female - Swivel
C3/C9	= METRIC Female - Swivel
D9	= BSP Rigid - Male
HB	= API Hub
HE	= 2" Hammer Union, cone w/ Wing Nut, Male
HN	= Hammer Union, Cone Threaded End w/ Seal, Female
HY	= Waterblast Nozzle - Female
MB	= STECKO
TU	= Tube Stub Fitting
Y2	= Medium Pressure - Tube Nipple
Y4	= High Pressure - Tube Nipple
YH	= Waterblast Nozzle - Male
YM	= Waterblast Nozzle - Male Metric



**Hose Part Numbers - Nomenclature**—page A-8

**Fitting Part Numbers - Nomenclature**—page B-4



**06 08 04 C 16 - 600**

**06 08 04**

Connection Type			Hose Size		
These two digits will indicate the SIZE of connection - End 1 and End 2.			When specifying hose size, indicate the two-digit code.		
JIC/Type M	BSP	MP & HP Tube (Sized by nominal tube O.D.)	Hose I.D.	Hose Dash Size	Code
01 = 1/4" - 28 UNF	02 = G 1/8" - 28	04 = 1/4" - 28	5/64"	-012	1A
02 = 5/16" - 24 UNF	04 = G 1/4" - 19	06 = 3/8" - 24	1/8"	-02	02
03 = 3/8" - 24 UNF	06 = G 3/8" - 19	09 = 9/16" - 18	5/32"	-025	2B
04 = 7/16" - 20 UNF	08 = G 1/2" - 14	12 = 3/4" - 16	3/16"	-03	03
05 = 1/2" - 20 UNF	<b>NPTF</b>	16 = 1" - 14	1/4"	-04	04
06 = 9/16" - 18 UNF	01 = 1/16" - 27		5/16"	-05	05
07 = 5/8" - 18 UNF	02 = 1/8" - 27		3/8"	-06	06
08 = 3/4" - 16 UNF	04 = 1/4" - 18		1/2"	-08	08
10 = 7/8" - 14 UNF	06 = 3/8" - 18		3/4"	-12	12
11 = 1" - 12 UNF	08 = 1/2" - 14		1"	-16	16
12 = 1-1/16" - 12 UNF	12 = 3/4" - 14		1-1/4"	-20	20
13 = 1-1/8" - 12 UNF	16 = 1" - 11-1/2		1-1/2"	-24	24
15 = 1-1/4" - 12 UNF	20 = 1-1/4" - 11-1/2		2"	-32	32
16 = 1-5/16" - 12 UNF	24 = 1-1/2" - 11-1/2		3"	-48	48
17 = 1-3/8" - 12 UNF	32 = 2" - 11-1/2				
19 = 1-1/2" - 12 UNF					
20 = 1-5/8" - 12 UNF					

**C 16 600**

Fitting Material	Hose Variation Number	Length
This letter indicates the material of the fittings used.  S=Carbon Steel C=Stainless Steel	This series of numbers will indicate the hose variation number. See pg. A-8 for detailed hose part number breakdown. Example: 2390N-04 V16	Indicate the assembly length in imperial units. This example is 600 inches.

# Hose Selection Chart

Nominal Size				Working Pressure psi [bar]							
				2240D	2248D	2380N-...W	2388N-...W	2440D	2448D	2440N	2580N
size	inch	mm	DN								
-02	1/8	3.2	3	15,950 (1,100)				30,000 (2,070)			
-025	5/32	4.0	4	17,400 (1,200)	21,750 (1,500)			31,900 (2,200)	43,645 (3,010)		
-03	3/16	4.8	5	15,955 (1,100)	20,300 (1,400)			26,100 (1,800)			
-04	1/4	6.4	6	15,950 (1,100)		15,950 (1,100)	18,560 (1,280)	23,780 (1,640)		20,300 (1,400)	
-05	5/16	7.9	8	13,050 (900)		14,500 (1,000)		21,750 (1,500)			
-06	3/8	9.5	10							20,300 (1,400)	23,200 (1,600)
-08	1/2	12.7	12			12,760 (880)	15,950 (1,100)			20,300 (1,400)	20,300 (1,400)
-12	3/4	19.0	20							14,500 (1,000)	17,400 (1,200)
-16	1	25.4	25							13,050 (900)	
Fitting Series				TX	TX	KY LX	KY BS	LX	LX	LX	BL
Page #				A-22	A-22	A-26	A-30	A-34	A-34	A-36	A-40

TOUGHJACKET™ versions rated the same as the base hose design.

# Working Pressure psi/bar- Waterblast 2½:1 Applications

	Working Pressure psi [bar]								Nominal Size			
	2640D	2640N	2648N	2740D	2748D	2749D	2840D	2849D	DN	mm	inch	size
										3	3.2	1/8
	40,600 (2,800)								4	4.0	5/32	-025
	36,230 (2,500)			40,600 (2,800)			*58,000 (4,000)		5	4.8	3/16	-03
									6	6.4	1/4	-04
				36,230 (2,500)	40,600 (2,800)	43,645 (3,010)	43,500 (3,000)	55,000 (3,800)	8	7.9	5/16	-05
									10	9.5	3/8	-06
		26,100 (1800)					36,250 (2,500)		12	12.7	1/2	-08
		20,300 (1400)	23,200 (1600)						20	19.0	3/4	-12
			21,750 (1500)						25	25.4	1	-16
	2X	5X	JX CX	2X	2X	2X	2X WX	WX	Fitting Series			
	A-42	A-44	A-44	A-46	A-46	A-46	A-48	A-50	Page #			

\* Not DIN EN 1829-2 qualified. Others are with PFDE fittings.

TOUGHJACKET™ versions rated the same as the base hose design.

# Hose Selection Chart

		Working Pressure psi [bar]							
Dimensions →	size	-012	-02	-025	-03	-04	-05	-06	
	inch	5/64	1/8	5/32	3/16	1/4	5/16	3/8	
Hose Type ↓	mm	2	3.2	4	4.8	6.4	7.9	9.5	
	DN	2	3	4	5	6	8	10	
Working Pressure psi [bar]	2020N	6,890 (475)	5,800 (400)						
	2022N					10,000 (690)		10,000 (690)	
	2380N			10,875 (750)		10,150 (700)	9,060 (625)		
	2388N					11,600 (800)			
	2390N					7,107 (490)			
	2580N								

# Working Pressure psi/bar - Hydraulic 4:1 Applications

Working Pressure psi [bar]								
	-08	-12	-16	-20	size	Dimensions ←	Fittings	Page
	1/2	3/4	1	1 1/4	inch	Hose Type ↓		
	12.7	19	25.4	31.8	mm			
	12	20	25	32	DN			
						2020N	EX / RX	A-18
	10,000 (690)					2022N	8X / 3X / LX	A-20
			5,510 (380)			2380N	8X / LX / E4	A-28
						2388N	8X	A-30
	6,017 (415)		4,060 (280)			2390N	8X / 9X E3 / E4	A-32
	10,150 (700)					2580N	BL	A-40

# Hose Selection Chart

Working Pressure psi [bar]								
Dimensions →	size	-04	-05	-06	-08	-12	-16	
	inch	1/4	5/16	3/8	1/2	3/4	1	
Hose Type ↓	mm	6.4	7.9	9.5	12.7	19	25.4	
	DN	6	8	10	12	20	25	
<b>High Pressure Aramid Hose</b>								
2022N-...10K	10,000 (690)			10,000 (690)	10,000 (690)			
HCR					5,000 (345)		5,000 (345)	
57CR						5,000 (345)	5,000 (345)	
<b>High Pressure Wire Hose, Polyamide</b>								
2380N							5,510 (380)	
2388N	11,600 (800)				15,950 (1,115)			
2390N	7,107 (490)			6,450 (445)	6,017 (415)		4,060 (280)	
2440N				12,688 (875)	11,745 (810)	10,000 (690)	8,120 (560)	
2440N-...10K							10,000 (690)	
2448N	15,000 (1,035)				12,688 (875)			
2640N						12,500 (875)		
<b>High Pressure Wire Hose, ChemJec</b>								
2440M	12,500 (875)	10,000 (690)	15,000 (1,035)	10,000 (690)				
2448M	15,000 (1,035)	15,000 (1,035)	10,000 (690)					
2640M					15,000 (1,035)			
<b>BOP and Hotline Hoses</b>								
2390N	7,107 (490)				6,017 (415)		4,060 (280)	
<b>Large Bore for Well Servicing (Black Eagle and Golden Eagle)</b>								
2240N								
2248N								
2440N								
2448N								
2580N-32V80								
2640N-...15K								
2648N-32V80								
2580M								
2640M								

# Working Pressure - Oil & Gas 4:1 Applications

Working Pressure psi [bar]								
	-20	-24	-32	-48	size	Dimensions	Fittings	Page
	1 1/4	1 1/2	2	3	inch	←		
	31.8	38.1	50.8	76	mm	Hose Type		
	32	40	50	78	DN	↓		
						2022N-...10K	8X/3X/LX	A-18
						HCR	HV	A-52
						57CR	CR	A-54
						2380N	8X/LX/E4	A-28
						2388N	8X/BS	A-30
						2390N	8X/9X/E3/E4	A-32
						2440N	8X/LX	A-36
						2440N-...10K	LX	A-38
						2448N	8X/LX	A-38
						2640N	5X	A-44
						2440M	8X/LX	A-68
						2448M	UX/LX	A-68
						2640M	5X	A-68
						2390N	8X/9X/E3/E4	A-32
			3,000 (207)	5,000 (345)		2240N	TX/S6	A-62, A-64
			5,000 (345)			2248N	S6	A-64
				10,000 (690)		2440N	LX	A-62
			5,000 (345)			2448N	5X	A-60
			10,000 (690)			2580N-32V80	5X	A-60
		15,000 (1,035)		15,000 (1,035)		2640N-...15K	5X	A-58
			15,000 (1,035)			2648N-32V80	CX	A-60
			10,000 (690)			2580M	5X	A-66
		10,000 (690)				2640M	5X	A-66

# 2020N- High Pressure Hose



## Features & Applications

- Very small hose I.D.
- Very flexible hose
- High pressure services where very small hose O.D. is required
- Versatile usage in mini-hydraulic and gas applications
- Measuring and diagnostic systems

## Markets

- Hydraulics



Part Number	Jacket Color	Nominal I.D.		Maximum O.D.		Maximum Working Pressure		Minimum Bend Radius		Weight		Fitting Series	
		DN	inch	inch	mm	psi	bar	inch	mm	lbs/ft	kg/m		
#													
2020N-012R30	Black	2	5/64	2.0	0.20	4.9	6,890	475	0.79	20	0.01	0.02	EX
2020N-02V30	Black	3	1/8	3.2	0.24	6.0	5,800	400	1.20	30	0.02	0.02	EX/RX*

## Construction

Core Tube: Polyamide

Reinforcement: One braided layer of high tensile strength synthetic fiber

Cover: Polyamide, pin-pricked

## Temperature Range

-012 sizes: -40°F to +180°F (-40°C to +82.2°C)

-02 sizes: -40°F to +212°F (-40°C to +100°C) with petroleum or synthetic hydraulic fluids and gases

## Notes

- Assembly working pressure is dependent on the lowest rated component. Therefore, if fittings have a lower pressure rating than the hose, the working pressure of the fittings is the working pressure of the assembly.
- Not for use in airless paint spray or solvent spraying applications. Not a static dissipative hose.
- Hose is pin-pricked for gas service.
- \*RX Series fittings are field assembled. Contact the division for more information.
- Refer to page F-26, paragraph 5 of "Notes on Chemical Resistance" section for gas applications.

## Options

Colors: ● Black



### WARNING

This product can expose you to chemicals including Titanium dioxide, which is known to the State of California to cause cancer. For more information go to [www.P65Warnings.ca.gov](http://www.P65Warnings.ca.gov).



# 2020N- Fittings and Accessories

## Fittings

Technical details available in Section B.

Hose Part <b>#</b>	2020N-012R30	2020N-02V30
Fitting Part Numbers 	101EX-2-012 101EX-4-012 106EX-4-012 1C9EX-6-012 1C9EX-8-012	106EX-4-02 1C9EX-8-02 201RX-2-2C 206RX-4-2C 2TURX-4-2C 601EX-2-2C

## Accessories

Technical details available in Section E.

Hose Part	Accessory Part Numbers
<b>#</b>	Bend Restrictor
2020N-02V30	MBR003 (w/ reusable fittings) MBR004 (w/ crimp fittings)



### WARNING

This product can expose you to chemicals including Lead, which is known to the State of California to cause cancer and birth defects or other reproductive harm. For more information go to [www.P65Warnings.ca.gov](http://www.P65Warnings.ca.gov).

# 2022N- High Pressure Hose



## Features and Applications

- Flexible and lightweight with excellent pressure capabilities
- Meets or exceeds SAE J517/J343 for less than 50 microamps leakage under 75000 volts per foot\*
- Smooth bore for improved flow rate and low pressure drop
- ISO 13628-5 "Specification for Subsea Production Control Umbilicals", Section 7.9 Hose construction
- Long-length hose and hose umbilicals requiring lightweight construction
- Oilfield pressure control devices
- Offshore oil applications (control fluids, acidizing, methanol injection, well stimulation)
- High pressure hydraulics, pneumatics and lubricating oils
- High pressure tools and jacks
- Test apparatus

## Markets



- Oil & Gas

Part Number	Jacket Color	Nominal I.D.		Maximum O.D.		Maximum Working Pressure		Minimum Bend Radius		Weight		Fitting Series	
		DN	inch	inch	mm	psi	bar	inch	mm	lbs/ft	kg/m		
#													
2022N-04V91-10K	Black	6	1/4	6.4	0.54	13.8	10,000	690	3.94	100	0.09	0.14	8X
2022N-06V91-10K	Black	10	3/8	9.5	0.75	19.0	10,000	690	3.94	100	0.16	0.24	3X
2022N-08V91-10K	Black	12	1/2	12.7	0.97	23.2	10,000	690	3.94	100	0.23	0.34	LX



- Hydraulics

2022N-04V15*	Orange	6	1/4	6.4	0.54	13.8	10,000	690	3.94	100	0.09	0.14	8X
2022N-04V10-P**	Black	6	1/4	6.4	0.54	13.8	10,000	690	3.94	100	0.09	0.14	8X

## Construction (V91)

Core Tube:

V91- Polyamide 11, methanol washed

Reinforcement: High tensile aramid fiber

Cover: V91- Sea water resistant

Polyurethane, pin-pricked on request to allow adequate venting of permeable fluids

## Construction (V1x)

Core Tube: Polyamide

Reinforcement: Aramid Fiber Braid

Cover: Polyurethane (Perforated on 2022N-04V10-P)

## Options

Colors: ● Black

● Orange

## Temperature Range

V91: -40°C to +55°C [-40°C to 131°F]

V1x: -40°C to +80°C [-40°C to 176°F]

## Notes

- Assembly working pressure is dependent on the lowest rated component. Therefore, if fittings have a lower pressure rating than the hose, the working pressure of the fittings is the working pressure of the assembly.
- V1x - Warning tags are required for all hose assemblies
- V1x - Bend restrictors are required for all hand held applications. Parker Parflex suggests the use bend restrictors for all assemblies
- \*\*In non-flammable gas transfer applications, use 2022N-04V10-P.
- Refer to page F-26, paragraph 5 of "Notes on Chemical Resistance" section for gas applications.



### WARNING

This product can expose you to chemicals including Titanium dioxide, which is known to the State of California to cause cancer. For more information go to [www.P65Warnings.ca.gov](http://www.P65Warnings.ca.gov).

# 2022N- Fittings and Accessories

## Fittings

Technical details available in Section B.

Hose Part #	2022N-04V91-10K	2022N-06V91-10K	2022N-08V91-10K	2022N-04V10 2022N-04V15
Fitting Part Numbers 	1018X-4-04C 1018X-6-04C 1068X-4-04C 1068X-6-04C 1A98X-6-04C 1C98X-8-04C 1C98X-10-04C	1063X-6-06C 1C93X-14-06C 1C93X-16-06C 1923X-8-06C 1063X-8-06C	106LX-8-08C 192LX-8-08C 1C9LX-16-08C 101LX-8-08C 1AYLX-11-08C	1018X-4-04 1018X-4-04C 1018X-6-04 1018X-6-04C 1068X-4-04 1068X-4-04C 1068X-6-04 1068X-6-04C 1A98X-6-04 1A98X-6-04C

## Accessories

Technical details available in Section E.

Hose Part #	Accessory Part Numbers
#	Bend Restrictor
2022N-04V10	HG2022N-4
2022N-04V15	HG2022N-4



### WARNING

This product can expose you to chemicals including Lead, which is known to the State of California to cause cancer and birth defects or other reproductive harm. For more information go to [www.P65Warnings.ca.gov](http://www.P65Warnings.ca.gov).

# 2240D/2248D- High Pressure Tube Cleaning Hose



## Features and Accessories

- 20% smaller O.D. than existing competitor products
- High pressure service for tube cleaning applications, such as, heat exchanger tube cleaning in the chemical and refining industries
- Flexible lance at working pressures of 13,000 psi and above

## Markets

- Waterblast



## Certifications

- DIN EN1829-2 compliant

Part Number	Jacket Color	Nominal I.D.			Maximum O.D.		Maximum Working Pressure		Minimum Bend Radius		Weight		Fitting Series
		DN	inch	mm	inch	mm	psi	bar	inch	mm	lbs/ft	kg/m	
#													
2240D-02V33-TC	Green	3	1/8	3.2	0.28	7.1	15,950	1,100	2.36	60	0.05	0.07	TX
2240D-025V33-TC	Green	4	5/32	4.0	0.30	7.7	17,400	1,200	2.95	75	0.07	0.10	TX/AX
2240D-03V33-TC	Green	5	3/16	4.8	0.37	9.5	15,955	1,100	3.74	95	0.09	0.13	TX
2240D-04V33-TC	Green	6	1/4	6.4	0.46	11.6	15,950	1,100	4.33	110	0.13	0.20	TX
2248D-025V32-TC	Blue	4	5/32	4.0	0.31	7.9	21,750	1,500	2.95	75	0.07	0.11	TX
2248D-03V32-TC	Blue	5	3/16	4.8	0.37	9.5	20,300	1,400	3.74	95	0.09	0.14	TX
2248D-05V33-TC	Green	8	5/16	7.9	0.53	13.5	15,000	1,034	4.72	120	0.17	0.25	TX

## Construction

Core Tube: Polyoxymethylene  
 Reinforcement: Two spiral layers of high tensile steel wire  
 Cover: Polyamide

## Options

Colors: Blue  
 Green

## Temperature Range

+14°F to +158°F (-10°C to +70°C)

## Notes

- Assembly working pressure is dependent on the lowest rated component. Therefore, if fittings have a lower pressure rating than the hose, the working pressure of the fittings is the working pressure of the assembly.
- -TC Tough Cover offers improved abrasion resistance over the standard.



### WARNING

This product can expose you to chemicals including Titanium dioxide, which is known to the State of California to cause cancer. For more information go to [www.P65Warnings.ca.gov](http://www.P65Warnings.ca.gov).

# 2240D/2248D- Fittings and Accessories

## Fittings

NPT max. working pressure: 15,000 psi. Technical details available in Section B.

Hose Part #	2240D-02V33-TC	2240D-025V3x-TC	2240D-03V3x-TC	2240D-04V3x-TC
Fitting Part Numbers 	101TX-1-02-PL 101TX-2-02-PL	101TX-1-025-PL 101TX-2-025-PL 1AYTX-6-025W	101TX-2-03-PL 101TX-2-03W 1AYTX-6-03W	101TX-4-04-PL
	2240D-05V36-TC	2248D-025V32-TC	2248D-03V32-TC	2248D-05V33-TC
	101TX-4-05-PL 101TX-6-05-PL 1AYTX-8-05W	1AYTX-6-025W 1YHTX-4-025-PL	1AYTX-6-03W 1YHTX-6-03-PL	101TX-4-05-PL 101TX-6-05-PL 1AYTX-8-05W

## Accessories

Technical details available in Section E.

Hose Part #	Accessory Part Numbers		Hose Stop
	Containment Grip	Bend Restrictor	
2240D-03V3x	MCG001SS MCGHS10-15	N/A	N/A
2240D-04V3x	MCG001SS MCGHS10-15	MBR008	N/A
2240D-05V36	MCG001SS MCGHS10-15	N/A	N/A
2240D-025V3x 2248D-025V32	N/A	N/A	AH-025S
2240D-03V3x 2248D-03V32	N/A	N/A	AH-03S
2240D-04V3x	N/A	N/A	AH-04S
2248D-05V33-TC	N/A	N/A	AH-05S



### WARNING

This product can expose you to chemicals including Lead, which is known to the State of California to cause cancer and birth defects or other reproductive harm. For more information go to [www.P65Warnings.ca.gov](http://www.P65Warnings.ca.gov).

# 2245N- High Pressure Hose



## Features and Applications

- High pressure hydraulic and industrial applications
- Excellent chemical resistance due to the polyamide core tube
- High pressure service for general industrial and mobile hydraulic applications, as well as with gases
- Use with a wide variety of fluids due to the polyamide core tube.
- Performance exceeds SAE 100R9.

## Markets

- Hydraulics



Part Number	Jacket Color	Nominal I.D.			Maximum O.D.		Maximum Working Pressure		Minimum Bend Radius		Weight		Fitting Series
		DN	inch	mm	inch	mm	psi	bar	inch	mm	lbs/ft	kg/m	
#													
2245N-04V00	Black	6	1/4	6.3	0.50	12.7	6,525	450	2.76	70	0.17	0.25	NX
2245N-08V30	Black	12	1/2	12.7	0.83	21.0	5,080	350	6.50	165	0.35	0.52	9X
2245N-12V30	Black	20	3/4	19.6	1.14	28.9	4,350	300	9.45	240	0.62	0.92	NX
2245N-16V30	Black	25	1	25.4	0.99	25.2	3,988	275	11.0	280	0.77	1.15	NX

## Construction

Core Tube: Polyamide  
 Reinforcement: Two spiral layers, and one braided layer of high tensile steel wire

Covers: V0x - Polyurethane  
 V3x - Polyamide

## Temperature Range

-40°F to +212°F (-40°C to +100°C) for petroleum or synthetic hydraulic fluids

## Notes

- Refer to page F-26, paragraph 5 of "Notes on Chemical Resistance" section for gas applications.

## Options

Colors: ● Black



### WARNING

This product can expose you to chemicals including Titanium dioxide, which is known to the State of California to cause cancer. For more information go to [www.P65Warnings.ca.gov](http://www.P65Warnings.ca.gov).

# 2245N- Fittings

## Fittings

Technical details available in Section B.

Hose Part #	2245N-04V0x	2245N-08V3x	2245N-12V3x	2245N-16V3x
Fitting Part Numbers 	601NX-2-4* 601NX-4-4* 602NX-4-4* 606NX-4-4C 606NX-6-4C 6AYNX-6-4C	1069X-8-08 1069X-8-08C 1C99X-16-08 1D29X-16-08	101NX-12-12 106NX-12-12 1D2NX-25-12 1U0NX-16-12	101NX-16-16 106NX-16-16 106NX-20-16 192NX-20-16

\* Prolance

OBSOLETE



**WARNING**

This product can expose you to chemicals including Lead, which is known to the State of California to cause cancer and birth defects or other reproductive harm. For more information go to [www.P65Warnings.ca.gov](http://www.P65Warnings.ca.gov).

# 2380N/2380N...W- High Pressure Hose



## Features and Applications

- Low volumetric expansion
- Available in long lengths
- Replaces high pressure, rigid tubing where vibration and routing constraints are issues
- High pressure service in construction and shipbuilding industries
- General industrial cleaning applications

## Certifications

- DIN EN1829-2 compliant, except type -04V66. -04V66 is compatible with phosphate ester fluids and is qualified for use in high pressure hydraulic applications

## Markets

- Waterblast



Part Number	Jacket Color	Nominal I.D.			Maximum O.D.		Maximum Working Pressure		Minimum Bend Radius		Weight		Fitting Series
		DN	inch	mm	inch	mm	psi	bar	inch	mm	lbs/ft	kg/m	
#													
2380N-05V03W	Green	8	5/16	7.9	0.62	15.8	15,000	1,035	3.54	90	0.24	0.35	KY

## Markets

- Hydraulics



Part Number	Jacket Color	Nominal I.D.			Maximum O.D.		Maximum Working Pressure		Minimum Bend Radius		Weight		Fitting Series
		DN	inch	mm	inch	mm	psi	bar	inch	mm	lbs/ft	kg/m	
#													
2380N-04V66	Yellow	6	1/4	6.4	0.50	12.7	13,200	910	2.80	70	0.18	0.27	NX

## Construction

Core Tube: Polyamide

Reinforcement: Two closed spiral layers and two open spiral layers of high tensile steel wire

Cover: V0x - Polyurethane  
V66 - Polyamide

## Temperature Range

+14°F to +158°F (-10°C to +70°C)

-04V66: -40°F to +212°F (-40°C to +100°C) in hydraulic applications

## Notes

- Assembly working pressure is dependent on the lowest rated component. Therefore, if fittings have a lower pressure rating than the hose, the working pressure of the fittings is the working pressure of the assembly.

## Options

Colors:  Yellow



### WARNING

This product can expose you to chemicals including Lead, which is known to the State of California to cause cancer and birth defects or other reproductive harm. For more information go to [www.P65Warnings.ca.gov](http://www.P65Warnings.ca.gov).



# 2380N/2380N...W- Fittings and Accessories

## Fittings

Technical details available in Section B.

Hose Part #	2380N-05V0xW	2380N-04V66
Fitting Part Numbers 	101KY-4-05 101KY-6-05 1AYKY-8-05 1Y4KY-9-05	101NX-4-4 101NX-6-4 1D9NX-4-4 601NX-4-4 606NX-4-4C 606NX-6-4C 6AYNX-6-4C

## Accessories

Technical details available in Section E.

Hose Part #	Accessory Part Numbers					
	Heavy Duty Abrasion Cover	Cover Sleeves	Spring Guard	Containment Grip	Bend Restrictor	Hose Stop
2380N-04V66	MHDC010	508-J-500-10	N/A	MCG001SS MCGHS10-15	N/A	N/A
2380N-05V0xW	MHDC012	510-A-500-12	N/A	MCG001SS MCGHS10-15	MBR012	AH-06S



**WARNING**

This product can expose you to chemicals including Lead, which is known to the State of California to cause cancer and birth defects or other reproductive harm. For more information go to [www.P65Warnings.ca.gov](http://www.P65Warnings.ca.gov).

# 2380N- High Pressure Hose

## Features and Applications



- Small diameters available
- Low volumetric expansion
- Available in long lengths and twinline construction
- Replaces high pressure, rigid tubing where vibration and routing constraints are issues
- Used for hydraulic controls and test systems with synthetic fluids
- Portable hydraulic tools
- -16 BOP hose - hydraulic systems - subsea control lines for BOP systems and long-length hot lines
- V91 meets/exceeds performance requirements of ISO 13628-5/API 17E

## Markets

- Oil & Gas
- Hydraulics



Part Number	Jacket Color	Nominal I.D.		Maximum O.D.		Maximum Working Pressure		Minimum Bend Radius		Weight		Fitting Series	
		DN	inch	inch	mm	psi	bar	inch	mm	lbs/ft	kg/m		
#													
2380N-025V10	Black	4	5/32	4.0	0.38	9.7	10,875	750	2.17	55	0.11	0.16	8X
2380N-04V00*	Black	6	1/4	6.4	0.52	13.3	10,150	700	2.80	70	0.18	0.27	8X
2380N-04V02*	Blue	6	1/4	6.4	0.52	13.3	10,150	700	2.80	70	0.18	0.27	8X
2380N-04V04*	Red	6	1/4	6.4	0.52	13.3	10,150	700	2.80	70	0.18	0.27	8X
2380N-04V06*	Yellow	6	1/4	6.4	0.53	13.4	10,150	690	2.80	70	0.18	0.27	8X
2380N-04V91	Black	6	1/4	6.4	0.53	13.4	10,000	690	2.80	70	0.18	0.27	8X
2380N-05V00*	Black	8	5/16	7.9	0.62	15.8	9,060	625	3.54	90	0.24	0.35	LX
2380N-16V12	Blue	25	1	25.4	1.45	36.8	5,510	380	11.42	290	1.00	1.49	E4
2380N-16V13	Green	25	1	25.4	1.45	36.8	5,510	380	11.42	290	1.00	1.49	E4
2380N-16V16	Yellow	25	1	25.4	1.45	36.8	5,510	380	11.42	290	1.00	1.49	E4

\* Not qualified for subsea applications

## Construction

Core Tube: Polyamide (V00)  
Polyamide 12, methanol washed (V91)

Reinforcement: Two closed spiral layers and two open spiral layers of high tensile steel wire

Cover: V0x — Polyurethane  
V1x — Seawater-resistant  
V9x — Polyamid PA12

## Options

Colors: ● Black ● Blue ● Green  
● Red ● Yellow

## Temperature Range

-40°F to +212°F (-40°C to +100°C)

## Notes

- Assembly working pressure is dependent on the lowest rated component. Therefore, if fittings have a lower pressure rating than the hose, the working pressure of the fittings is the working pressure of the assembly.



### WARNING

This product can expose you to chemicals including Lead, which is known to the State of California to cause cancer and birth defects or other reproductive harm. For more information go to [www.P65Warnings.ca.gov](http://www.P65Warnings.ca.gov).

# 2380N- Fittings and Accessories

## Fittings

Technical details available in Section B.

Hose Part #	2380N-04V0x	2380N-04V91	2380N-025V10	2380N-05V00	
Fitting Part Numbers 	1018X-4-04 1018X-4-04C 1018X-6-04 1018X-6-04C 1C38X-8-04 1D98X-4-04 1D98X-4-04C 1AY8X-6-04 1928X-4-04 1928X-4-04C 1068X-4-04	1068X-4-04C 1068X-6-04 1068X-6-04C 1028X-4-04 1028X-4-04C 15Y8X-6-04C 1C98X-8-04C 1MB8X-6-4	1068X-4-04C 1068X-6-04C 1018X-4-04C 1018X-6-04C 1AY8X-6-04C 1C98X-8-04C	1018X-2-025 1018X-4-025 1068X-4-025	601LX-4-5C 601LX-6-5 601LX-6-5C 6AYLX-8-5C 606LX-6-5C 606LX-8-5C
	2380N-16V1x				
	106E4-16-16C 137E4-16-16C-411 139E4-16-16C-411 19GE4-16-16C 19GE4-24-16C	19ME4-24-16C 19ME4-16-16C 19WE4-16-16C 19WE4-24-16C			

## Accessories

Technical details available in Section E.

Hose Part #	Accessory Part Numbers				
#	Heavy Duty Abrasion Cover	Cover Sleeves	Spring Guard	Containment Grip	Bend Restrictor
2380N-025V10	N/A	N/A	N/A	N/A	MBR008
2380N-04V0x	MHDC012	510-A-500-12	MSG2106	MCG001SS MCGHS10-15	MBR010 *HG8X-04

\*Rigid polymer Ø1-3/16" x 5-1/8" length



### WARNING

This product can expose you to chemicals including Lead, which is known to the State of California to cause cancer and birth defects or other reproductive harm. For more information go to [www.P65Warnings.ca.gov](http://www.P65Warnings.ca.gov).

# 2388N/2388N...W- High Pressure Hose



## Features and Applications

- Up to 35% lighter weight for a 20 meter hose assembly when compared to rubber hose
- High kink resistance
- Waterblast hoses DIN EN1829-2 compliant
- Hoses indicated for waterblast applications intended for construction, ship building and general industrial cleaning
- Particularly well-suited for the removal of dirt, rust and paint from the surface of ship decks, tanks, concrete and asphalt
- Grease injection hose
- High flexibility for hydraulic tools, rescue equipment, straightening benches and clamps

## Markets

- Waterblast
- Hydraulics



## Certifications

- DIN EN1829-2 compliant

Part Number	Jacket Color	Nominal I.D.			Maximum O.D.		Maximum Working Pressure		Minimum Bend Radius		Weight		Fitting Series
		DN	inch	mm	inch	mm	psi	bar	inch	mm	lbs/ft	kg/m	
#													
2388N-04V13W	Green	6	1/4	6.4	0.53	13.4	18,560	1,280	1.58	40	0.20	0.30	KY
2388N-04V14W	Red	6	1/4	6.4	0.53	13.4	18,560	1,280	1.58	40	0.20	0.30	KY
2388N-08V12	Blue	12	1/2	12.7	0.91	23.1	15,950	1,100	4.72	120	0.54	0.80	BS
2388N-08V13	Green	12	1/2	12.7	0.91	23.1	15,950	1,100	4.72	120	0.54	0.80	BS
2388N-08V14	Red	12	1/2	12.7	0.91	23.1	15,950	1,100	4.72	120	0.54	0.80	BS

## Construction

Core Tube: Polyamide

Reinforcement: Two spiral layers and two open spiral layers of high tensile steel wire

Cover: Polyurethane

## Options

Colors: Green Red  
 Blue

## Temperature Range

Waterblast hoses: 14°F to +158°F (-10°C to +70°C)

Hydraulic hose: -40°F to +212°F (-40°C to +100°C)

## Notes

- Assembly working pressure is dependent on the lowest rated component. Therefore, if fittings have a lower pressure rating than the hose, the working pressure of the fittings is the working pressure of the assembly



### WARNING

This product can expose you to chemicals including Lead, which is known to the State of California to cause cancer and birth defects or other reproductive harm. For more information go to [www.P65Warnings.ca.gov](http://www.P65Warnings.ca.gov).

# 2388N/2388N...W Fittings and Accessories

## Fittings

Technical details available in Section B.

Hose Part <b>#</b>	2388N-04V1xW	2388N-08V1x
Fitting Part Numbers 	101KY-4-04 101KY-6-04 1AYKY-6-04 1AYKY-6-04C	1AYBS-11-08 1AYBS-11-08C 101BS-8-08 101BS-8-08C 1C9BS-16-08 1C9BS-16-08C

## Accessories

Technical details available in Section E.

Hose Part	Accessory Part Numbers			
<b>#</b>	Heavy Duty Abrasion Cover	Cover Sleeves	Hose Stop	Containment Grip
2388N-08V1x	MHDC018	216-200-18	AH-08S	MCGHS 30-40
2388N-04V1xW	MHDC012	510-A-500-12	NA	NA



**WARNING**

This product can expose you to chemicals including Lead, which is known to the State of California to cause cancer and birth defects or other reproductive harm. For more information go to [www.P65Warnings.ca.gov](http://www.P65Warnings.ca.gov).

# 2390N- High Pressure Hose



## Features and Applications

- Low dimensional change under pressure resulting in excellent response times
- Smooth bore for low pressure drop
- Meets or exceeds the performance requirements of ISO 13628-5
- Low volumetric expansion hose
- Used for hydraulic systems - subsea control lines for BOP systems and long-length hot lines
- Portable hydraulic tools

## Markets

- Oil & Gas
- Hydraulics



Part Number	Jacket Color	Nominal I.D.		Maximum O.D.		Maximum Working Pressure		Minimum Bend Radius		Weight		Fitting Series	
		inch	mm	inch	mm	psi	bar	inch	mm	lbs/ft	kg/m		
#													
		DN	inch	mm	inch	mm	psi	bar	inch	mm	lbs/ft	kg/m	
2390N-04V10	Black	6	1/4	6.4	0.52	13.3	7,107	490	2.76	70	0.17	0.25	8X/9X/E3
2390N-04V12	Blue	6	1/4	6.4	0.52	13.3	7,107	490	2.76	70	0.17	0.25	8X/9X/E3
2390N-04V16	Yellow	6	1/4	6.4	0.52	13.3	7,107	490	2.76	70	0.17	0.25	8X/9X/E3
2390N-06V13	Green	10	3/8	9.5	0.71	18.1	6,450	445	4.72	120	0.28	0.41	9X
2390N-08V12	Blue	12	1/2	12.7	0.83	21.2	6,017	415	5.91	150	0.36	0.54	9X/E3
2390N-08V13	Green	12	1/2	12.7	0.83	21.2	6,017	415	5.91	150	0.36	0.54	9X/E3
2390N-08V16	Yellow	12	1/2	12.7	0.83	21.2	6,017	415	5.91	150	0.36	0.54	9X/E3
2390N-16V12	Blue	25	1	25.4	1.38	35.0	4,060	280	11.02	280	0.79	1.17	E4
2390N-16V13	Green	25	1	25.4	1.38	35.0	4,060	280	11.02	280	0.79	1.17	E4
2390N-16V16	Yellow	25	1	25.4	1.38	35.0	4,060	280	11.02	280	0.79	1.17	E4

## Construction

Core Tube: Polyamide

Reinforcement: Two closed spiral layers and two open spiral layers of high tensile steel wire

Cover: V1x - Seawater-resistant Polyurethane  
V00 - Polyurethane

## Temperature Range

-40°F to +212°F (-40°C to +100°C)

## Notes

- Assembly working pressure is dependent on the lowest rated component. Therefore, if fittings have a lower pressure rating than the hose, the working pressure of the fittings is the working pressure of the assembly.

## Options

Colors: Blue Yellow  
 Green Black



### WARNING

This product can expose you to chemicals including Lead, which is known to the State of California to cause cancer and birth defects or other reproductive harm. For more information go to [www.P65Warnings.ca.gov](http://www.P65Warnings.ca.gov).

# 2390N- Fittings and Accessories

## Fittings

Technical details available in Section B.

Hose Part #	2390N-04Vxx	2390N-06V13	2390N-08V1x	2390N-16V1x
Fitting Part Numbers 	1018X-4-04C 1018X-6-04C 1068X-4-04C 1068X-6-04C *106E3-4-4C *106E3-6-4C 1AY8X-6-04C *137E3-4-4C *137E3-6-4C *139E3-4-4C *139E3-6-4C	6019X-6-6 6019X-6-6C 6019X-8-6 6019X-8-6C 6AY9X-8-6C	*106E3-8-8C *106E3-8-8C *137E3-8-8C-411 *139E3-8-8C-411 *19WE3-8-8C *19WE3-16-8C *19ME3-8-8C *19ME3-16-8C *19GE3-8-8C *19GE3-16-8C 6019X-8-8 6019X-8-8C 6069X-8-8C 6AY9X-11-8C	106E4-16-16C* 137E4-16-16C-411C* 139E4-16-16C-411C* 19GE4-16-16C* 19GE4-24-16C* 19ME4-16-16C* 19ME4-24-16C* 19WE4-16-16C* 19WE4-24-16C* 6019X-16-16C 6069X-16-16C 6AY9X-16-16C

\* Parkrimp II crimping compatible.

## Accessories

Technical details available in Section E.

Hose Part #	Accessory Part Numbers		
	Heavy Duty Abrasion Cover	Cover Sleeves	Containment Grip
2390N-04Vxx	MHDC010	508-J-500-10	MCG001SS
2390N-08V1x	MHDC016	216-200-18	MCG005SS MCGHS20-30
2390N-16V1x	MHDC024	220-200-22	MCG003SS MCGHS30-40



**WARNING**

This product can expose you to chemicals including Lead, which is known to the State of California to cause cancer and birth defects or other reproductive harm. For more information go to [www.P65Warnings.ca.gov](http://www.P65Warnings.ca.gov).

# 2440D/2448D- Ultra High Pressure Water Jetting Hose



## Features and Applications

- High pressure service for tube cleaning applications such as heat exchangers in the chemical and oil refining industries
- Ultra high pressure waterblast lances for the construction and shipbuilding industries, common industrial cleaning applications, and high pressure tube cleaning in petrochemical and power plants
- Hydrodemolition and removal of accumulated dirt and material from surfaces such as concrete, asphalt and tanks

## Markets

- Waterblast



## Certifications

- DIN EN1829-2 compliant

Part Number	Jacket Color	Nominal I.D.			Maximum O.D.		Maximum Working Pressure		Minimum Bend Radius		Weight		Fitting Series
		DN	inch	mm	inch	mm	psi	bar	inch	mm	lbs/ft	kg/m	
#													
2440D-02V37-TC	Gray	3	1/8	3.2	0.31	7.9	30,000	2,070	3.94	100	0.08	0.12	LX
2440D-025V37-TC	Gray	4	5/32	4.0	0.41	10.5	31,900	2,200	3.94	100	0.14	0.21	LX
2440D-03V32-TC	Blue	5	3/16	4.8	0.45	11.5	26,100	1,800	5.12	130	0.19	0.28	LX
2440D-04V32-TC	Blue	6	1/4	6.4	0.49	12.5	23,780	1,640	6.10	155	0.22	0.33	LX
2440D-05V32-TC	Blue	8	5/16	7.9	0.59	15.1	21,750	1,500	6.89	175	0.30	0.44	LX
2448D-025V35-TC	Orange	4	5/32	4.0	0.39	9.9	43,645	3,010	4.72	120	0.15	0.22	LX

## Construction

**Core Tube:** Polyoxymethylene

**Reinforcement:** Four spiral layers of maximum tensile steel wire

**Cover:** Polyamide

## Options

Colors: ● Blue  
● Gray  
● Orange

## Temperature Range

+14°F to +158°F (-10°C to +70°C)

## Notes

- Assembly working pressure is dependent on the lowest rated component. Therefore, if fittings have a lower pressure rating than the hose, the working pressure of the fittings is the working pressure of the assembly.



### WARNING

This product can expose you to chemicals including Lead, which is known to the State of California to cause cancer and birth defects or other reproductive harm. For more information go to [www.P65Warnings.ca.gov](http://www.P65Warnings.ca.gov).



# 2440D/2448D- Fittings and Accessories

## Fittings

Technical details available in Section B.

Hose Part #	2440D-02V3x-TC	2440D-025V37-TC	2440D-03V32-TC
Fitting Part Numbers 	1AYLX-6-02 1Y4LX-4-02 6YHLX-4-02-PL	6AYLX-6-2AC 6HYLX-4-2AC-PL 6HYLX-4-2AC-PL-LH 6HYLX-6-2AC-PL-LH 6Y4LX-4-2AC 6Y4LX-6-2AC 6YHLX-4-2AC-PL 6YHLX-4-2AC-PL-LH	65YLX-6-3 65YLX-6-3C 66YLX-4-3 66YLX-4-3C 6AYLX-6-3 6AYLX-6-3C 6HYLX-4-3C-PL 6HYLX-4-3C-PL-LH 6HYLX-6-3C-PL 6HYLX-6-3C-PL-LH 6Y4LX-9-3C 6YHLX-4-3C-PL 6YHLX-4-3C-PL-LH 6YHLX-6-3C-PL 6YHLX-6-3C-PL-LH
	2440D-04V32-TC	2440D-05V32-TC	2448D-025V3x-TC
	1AYLX-6-04C 1Y2LX-6-04 6HYLX-6-4C-PL 6HYLX-6-4C-PL-LH 6YHLX-6-4C-PL 6YHLX-6-4C-PL-LH	6AYLX-8-5C 6HYLX-9-5C-PL-LH 6Y2LX-9-5C 6YHLX-9-5C-PL 6YHLX-9-5C-PL-LH 6Y2HX-9-5C-LONG 6Y2HX-9-5C-THD	6HYLX-4-2AC-PL 6HYLX-4-2AC-PL-LH 6YHLX-4-2AC-PL 6YHLX-4-2AC-PL-LH 6HYLX-6-2AC-PL-LH 6AYLX-6-2AC 6Y4LX-4-2AC 6Y4LX-6-2AC

## Accessories

Technical details available in Section E.

Hose Part #	Accessory Part Numbers			
#	Hose Stop	Spring Guard & Crimp Sleeve	Heavy Duty Abrasion Cover	Cover Sleeves
2448D-025V35-TC 2440D-025V37-TC	AH-04S	N/A	-	-
2440D-03V32-TC	AH-05S	MSG060 508-J-500-10	-	-
2440D-04V32-TC	AH-05S	N/A	MHDC010	508-J-500-10
2440D-05V32-TC	AH-06S	N/A	PVC-BLUE-012	510-A-500-12



**WARNING**

This product can expose you to chemicals including Lead, which is known to the State of California to cause cancer and birth defects or other reproductive harm. For more information go to [www.P65Warnings.ca.gov](http://www.P65Warnings.ca.gov).

# 2440N- Ultra High Pressure Waterblast Hose



## Features and Applications

- High pressure, low volumetric expansion hose
- Flexible, chemical-resistant, lightweight alternative to steel pipe and rubber hose
- Ultra high pressure service for the construction and shipbuilding industries and general industrial cleaning applications
- Mainly used in hydrodemolition and to remove different kinds of dirt accumulation, or materials from various surfaces
- Waterjet technology delivery hose

## Markets

- Waterblast



## Certifications

- DIN EN1829-2 compliant

Part Number	Jacket Color	Nominal I.D.		Maximum O.D.		Maximum Working Pressure		Minimum Bend Radius		Weight		Fitting Series	
		inch	mm	inch	mm	psi	bar	inch	mm	lbs/ft	kg/m		
#													
		DN	inch	mm	inch	mm	psi	bar	inch	mm	lbs/ft	kg/m	
2440N-04V32	Blue	6	1/4	6.4	0.51	13.0	20,300	1,400	6.10	155	0.21	0.31	LX
2440N-06V32	Blue	10	3/8	9.5	0.77	19.5	20,300	1,400	7.48	190	0.49	0.73	LX
2440N-08V32	Blue	12	1/2	12.7	0.89	22.7	20,300	1,400	7.87	200	0.63	0.94	LX
2440N-12V36	Yellow	20	3/4	19.0	1.19	30.2	14,500	1,000	9.84	250	0.98	1.46	LX
2440N-16V36	Yellow	25	1	25.4	1.46	37.2	13,050	900	11.81	300	1.34	2.00	LX
TOUGHJACKET™													
2440N-08V30/12	Blue	12	1/2	12.7	1.13	28.6	20,300	1,400	7.90	200	0.81	1.21	LX

## Construction

Core Tube: Polyamide

Reinforcement: Four spiral layers of maximum tensile steel wire

Cover: Polyamide

## Options

Colors: Blue  
 Yellow

## Temperature Range

+14°F to +158°F (-10°C to +70°C)

## Notes

- Assembly working pressure is dependent on the lowest rated component. Therefore, if fittings have a lower pressure rating than the hose, the working pressure of the fittings is the working pressure of the assembly.



**TOUGHJACKET**

Built in abrasion resistance eliminates the need for an additional PVC sleeve and lightens the hose by up to 16%.



### WARNING

This product can expose you to chemicals including Lead, which is known to the State of California to cause cancer and birth defects or other reproductive harm. For more information go to [www.P65Warnings.ca.gov](http://www.P65Warnings.ca.gov).

# 2440N- Fittings and Accessories

## Fittings

Technical details available in Section B.

Hose Part #	2440N-04V32	2440N-06V32	2440N-08V3x 2440N-08V30/12
Fitting Part Numbers 	6AYLX-6-4 6AYLX-6-4C 65YLX-6-4C 6YHLX-6-4C 6YHLX-6-4C-LH 6HYLX-6-4C-PL 6HYLX-6-4C-PL-LH 6YHLX-6-4C-PL 6YHLX-6-4C-PL-LH	1Y2LX-9-06C 1AYLX-8-06C	6AYLX-11-8C 6C9LX-16-8 6Y2LX-12-8C 6Y2LX-9-8C
	2440N-12V3x	2440N-16V3x	
	601LX-12-12C 601LX-16-12C 606LX-16-12C 6AYLX-16-12C 6C9LX-25-12 6Y2LX-16-12C	601LX-16-16C 606LX-16-16C 6AYLX-16-16C 6C9LX-30-16C	

## Accessories

Technical details available in Section E.

Hose Part	Accessory Part Numbers			
#	Heavy Duty Abrasion Cover	Cover Sleeves	Spring Guard	Containment Grip
2440N-04V32	PVC-BLUE-012	510-A-500-12	MSG060 508-J-500-10	N/A
2440N-06V32	MHDC016	216-200-18	N/A	N/A
2440N-08V3x	PVC-BLUE-018	216-200-18	N/A	MCGHS20-30
2440N-08V30/12	N/A	*P2529-85AL	N/A	MCG002SS MCGHS20-30
2440N-12V3x	MHDC024	220-200-22	N/A	MCG002SS MCGHS30-40
2440N-16V3x	MHDC026	520-A-500-26	N/A	MCG003SS MCGHS30-40

\* Cover sleeve required on TOUGHJACKET hose assemblies.



### WARNING

This product can expose you to chemicals including Lead, which is known to the State of California to cause cancer and birth defects or other reproductive harm. For more information go to [www.P65Warnings.ca.gov](http://www.P65Warnings.ca.gov).

# 2440N/2448N- Ultra High Pressure Hose



## Features and Applications

- High pressure, low volumetric expansion hose
- Flexible, chemical-resistant, lightweight alternative to steel pipe and rubber hose
- V91 hoses are used in offshore applications such as, control fluids, acidizing, methanol injection and well stimulation

## Markets

- Oil & Gas
- Hydraulics



## Certifications

- ISO 13628-5 compliant

Part Number	Jacket Color	Nominal I.D.		Maximum O.D.		Maximum Working Pressure		Minimum Bend Radius		Weight		Fitting Series	
		inch	mm	inch	mm	psi	bar	inch	mm	lbs/ft	kg/m		
#													
		DN	inch	mm	inch	mm	psi	bar	inch	mm	lbs/ft	kg/m	
2440N-06V91	Black	10	3/8	9.5	0.77	19.5	12,688	875	7.48	190	0.49	0.73	LX
2440N-08V91*	Black	12	1/2	12.7	0.89	22.7	11,745	810	7.87	200	0.63	0.94	LX
2440N-12V91	Black	20	3/4	19.0	1.19	30.2	10,000	690	9.84	250	0.98	1.46	LX
2440N-16V91	Black	25	1	25.4	1.46	37.2	8,120	560	11.81	300	1.34	2.00	LX
2448N-04V91	Black	6	1/4	6.4	0.54	13.7	15,000	1,035	5.90	150	0.26	0.38	8X
2448N-08V91	Black	12	1/2	12.7	0.89	22.7	12,688	875	7.87	200	0.63	0.94	LX

## Construction

Core Tube: Methanol-washed PA11

Reinforcement: Four spiral layers of maximum tensile steel wire

Cover: PA12

## Options

Colors: ● Black

## Temperature Range

-40°F to +212°F (-40°C to +100°C)

## Notes

- Assembly working pressure is dependent on the lowest rated component. Therefore, if fittings have a lower pressure rating than the hose, the working pressure of the fittings is the working pressure of the assembly.



### WARNING

This product can expose you to chemicals including Lead, which is known to the State of California to cause cancer and birth defects or other reproductive harm. For more information go to [www.P65Warnings.ca.gov](http://www.P65Warnings.ca.gov).

# 2440N/2448N- Fittings and Accessories

## Fittings

Technical details available in Section B.

Hose Part #	2440N-06V91	2440N-08V91 2448N-08V91	2440N-12V91
Fitting Part Numbers 	1AYLX-8-06C4462 106LX-8-06C4462 106LX-6-06C4462 1Y2LX-9-06C4462 1Y2LX-6-06C4462	106LX-8-08C 101LX-8-08C 1C9LX-16-08C 1Y2LX-12-08C	106LX-16-12C4462 1AYLX-16-12C4462 1Y2LX-12-12C4462 1Y2LX-16-12C4462
	2440N-16V91	2448N-04V91	
	106LX-16-16C4462 1Y2LX-16-16C4462	1018X-4-04C 1018X-6-04C 1068X-4-04C 1068X-6-04C 1928X-4-04C 1AY8X-6-04C 1Y28X-6-04C 15Y8X-6-04C	

## Accessories

Technical details available in Section E.

Hose Part	Accessory Part Numbers		
#	Heavy Duty Abrasion Cover	Cover Sleeves	Containment Grip
2448N-04V91	MHDC012	510-A-500-12	MCG001SS MCGHS10-15
2440N-06V91	MHDC016	216-200-18	MCGHS15-20
2440N-08V91 2448N-08V91	N/A	N/A	MCGHS20-30
2440N-12V91	MHDC024	220-200-22	MCG002SS MCGHS30-40
2440N-16V91	MHDC026	520-A-500-26	MCG003SS MCGHS30-40



**WARNING**

This product can expose you to chemicals including Lead, which is known to the State of California to cause cancer and birth defects or other reproductive harm. For more information go to [www.P65Warnings.ca.gov](http://www.P65Warnings.ca.gov).

# 2580N- Ultra High Pressure Waterblast Hose



## Features and Applications

- Ultra high pressure service for the construction and shipbuilding industries
- General industrial cleaning applications
- Mainly used in hydrodemolition and to remove different kinds of dirt accumulation, or materials from various surfaces, such as those in tanks, from concrete, asphalt, etc.

## Markets

- Waterblast



## Certifications

- DIN EN1829-2 compliant

Part Number	Jacket Color	Nominal I.D.			Maximum O.D.		Maximum Working Pressure		Minimum Bend Radius		Weight		Fitting Series
		DN	inch	mm	inch	mm	psi	bar	inch	mm	lbs/ft	kg/m	
#													
2580N-06V12	Blue	10	3/8	9.5	0.85	21.6	23,200	1,600	3.74	95	0.63	0.94	BL
2580N-08V12	Blue	12	1/2	12.7	0.99	25.2	20,300	1,400	5.91	150	1.19	0.80	BL
2580N-12V13	Green	20	3/4	19.0	1.29	32.8	17,400	1,200	6.69	170	1.18	1.76	BL

## Construction

Core Tube: Polyamide

Reinforcement: Four spiral layers and two open spiral layers of high tensile steel wire

Cover: Polyurethane

## Options

- Colors: Blue  
 Green

## Temperature Range

+14°F to +158°F (-10°C to +70°C)

## Notes

- Assembly working pressure is dependent on the lowest rated component. Therefore, if fittings have a lower pressure rating than the hose, the working pressure of the fittings is the working pressure of the assembly.



### WARNING

This product can expose you to chemicals including Lead, which is known to the State of California to cause cancer and birth defects or other reproductive harm. For more information go to [www.P65Warnings.ca.gov](http://www.P65Warnings.ca.gov).

# 2580N- Fittings and Accessories

## Fittings

Technical details available in Section B.

Hose Part #	2580N-06V12	2580N-08V12	2580N-12V1x
Fitting Part Numbers 	1AYBL-11-06 1AYBL-8-06 1C9BL-14-06 1C9BL-16-06	1AYBL-11-08 1AYBL-11-08C 1C9BL-14-08 1C9BL-16-08 1C9BL-25-08	101BL-12-12 1C9BL-25-12

## Accessories

Technical details available in Section E.

Hose Part	Accessory Part Numbers
#	Hose Stop
2580N-08V12	AH-08S
2580N-12V13	AH-12S



**WARNING**

This product can expose you to chemicals including Lead, which is known to the State of California to cause cancer and birth defects or other reproductive harm. For more information go to [www.P65Warnings.ca.gov](http://www.P65Warnings.ca.gov).

# 2640D- Ultra High Pressure Waterblast Hose



## Features and Applications

- Ultra high pressure service for the construction and shipbuilding industries
- General industrial cleaning applications
- Hydrodemolition

## Markets

- Waterblast



## Certifications

- DIN EN1829-2 compliant

Part Number	Jacket Color	Nominal I.D.			Maximum O.D.		Maximum Working Pressure		Minimum Bend Radius		Weight		Fitting Series
		DN	inch	mm	inch	mm	psi	bar	inch	mm	lbs/ft	kg/m	
#													
2640D-025V35	Orange	4	5/32	4.0	0.47	12.0	40,600	2,800	5.51	140	0.20	0.29	2X
2640D-03V37	Gray	5	3/16	4.8	0.51	12.9	36,230	2,500	6.89	175	0.28	0.41	2X

## Construction

Core Tube: Polyoxymethylene  
 Reinforcement: Six spiral layers of maximum tensile steel wire  
 Cover: Polyamide

## Temperature Range

+14°F to +158°F (-10°C to +70°C)

## Options

Colors: ● Orange  
● Gray

## Notes

- Assembly working pressure is dependent on the lowest rated component. Therefore, if fittings have a lower pressure rating than the hose, the working pressure of the fittings is the working pressure of the assembly.



### WARNING

This product can expose you to chemicals including Lead, which is known to the State of California to cause cancer and birth defects or other reproductive harm. For more information go to [www.P65Warnings.ca.gov](http://www.P65Warnings.ca.gov).



# 2640D- Fittings and Accessories

## Fittings

Technical details available in Section B.

Hose Part <b>#</b>	2640D-025V3x	2640D-03V3x
Fitting Part Numbers 	16Y2X-4-025 1AY2X-6-025 1AY2X-6-025C 1Y42X-4-025 1Y42X-4-025C 1Y42X-6-025 1Y42X-6-025C	16Y2X-4-03 1922X-4-03 1AY2X-6-03 1AY2X-6-03C 1Y42X-4-03 1Y42X-4-03C 1Y42X-6-03 1Y42X-6-03C 1Y42X-9-03 1Y42X-9-03C

## Accessories

Technical details available in Section E.

Hose Part	Accessory Part Numbers			
<b>#</b>	Heavy Duty Abrasion Cover	Cover Sleeves	Containment Grip	Hose Stop
2640D-025V3x	MHDC010	508-J-500-10	MCGHS10-15	NA
2640D-03V3x	MHDC012	510-A-500-12	MCG001SS MCGHS10-15	AH-05S



**WARNING**

This product can expose you to chemicals including Lead, which is known to the State of California to cause cancer and birth defects or other reproductive harm. For more information go to [www.P65Warnings.ca.gov](http://www.P65Warnings.ca.gov).

# 2640N/2648N- Ultra High Pressure Hose



## Features and Applications

- Ultra high pressure service for the construction and shipbuilding industries
- General industrial cleaning applications
- V91 hoses are used in offshore applications such as, control fluids, acidizing, methanol injection and well stimulation
- V91 hose tested according to ISO 13628-5

## Markets

- Waterblast



## Certifications

- DIN EN1829-2 compliant

Part Number	Jacket Color	Nominal I.D.			Maximum O.D.		Maximum Working Pressure		Minimum Bend Radius		Weight		Fitting Series
		DN	inch	mm	inch	mm	psi	bar	inch	mm	lbs/ft	kg/m	
#													
2640N-08V32	Blue	12	1/2	12.7	0.96	24.5	26,100	1,800	11.42	290	0.92	1.37	JX
2640N-12V32	Blue	20	3/4	19.0	1.30	33.0	20,300	1,400	13.78	350	1.45	2.16	5X
2648N-12V32	Blue	20	3/4	19.0	1.33	33.7	23,200	1,600	13.78	350	1.53	2.28	JX
2648N-16V32	Blue	25	1	25.4	1.61	40.8	21,750	1,500	15.75	400	2.08	3.10	CX

## Markets

- Oil & Gas



Part Number	Jacket Color	Nominal I.D.			Maximum O.D.		Maximum Working Pressure		Minimum Bend Radius		Weight		Fitting Series
		DN	inch	mm	inch	mm	psi	bar	inch	mm	lbs/ft	kg/m	
#													
2640N-12V91	Black	20	3/4	19.0	1.31	33.2	12,500	875	13.78	350	1.45	2.16	5X

## Construction

Core Tube: Polyamide  
V91 - Methanol-washed PA11

Reinforcement: Six spiral layers of maximum tensile steel wire

Cover: V32 - Polyamide  
V91 - Plasticized Nylon 12

## Options

Colors:  Blue  Black

## Temperature Range

Waterblast hoses: -40°F to +212°F (-40°C to +100°C),  
+14°F to +158°F (-10°C to +70°C) for water

O&G hose: -40°F to +212°F (-40°C to +100°C)

## Notes

- Assembly working pressure is dependent on the lowest rated component. Therefore, if fittings have a lower pressure rating than the hose, the working pressure of the fittings is the working pressure of the assembly.



### WARNING

This product can expose you to chemicals including Lead, which is known to the State of California to cause cancer and birth defects or other reproductive harm. For more information go to [www.P65Warnings.ca.gov](http://www.P65Warnings.ca.gov).

# 2640N/2648N- Fittings and Accessories

## Fittings

Technical details available in Section B.

Hose Part #	2640N-08V32	*2640N-12V32	2640N-12V91
Fitting Part Numbers 	1AYJX-11-08W 1C9JX-16-08W	6AY5X-16-12C 6C95X-25-12C 6Y25X-16-12C-SL	6AY5X-16-12C-INC725 6Y25X-16-12C-INC725
	2648N-12V32	2648N-16V32	
	1AYJX-16-12W 1C9JX-25-12W	1C9CX-30-16W 1AYCX-16-16	

\* Fittings listed are a grade of stainless not qualified with V91 hose. Use only on V32 hose assemblies.

## Accessories

Technical details available in Section E.

Hose Part #	Accessory Part Numbers		
#	Heavy Duty Abrasion Cover	Cover Sleeves	Containment Grip
2640N-08V32	PVC-BLUE-024	220-200-22	MCGHS20-30
2640N-12V32	PVC-BLUE-024	220-200-22	MCGHS30-40
2640N-12V91	MHDC024	220-200-22	MCGHS30-40
2648N-12V32	MHDC026	520-A-500-26	MCGHS30-40
2648N-16V32	MHDC032	532-500	MCG003SS



**WARNING**

This product can expose you to chemicals including Lead, which is known to the State of California to cause cancer and birth defects or other reproductive harm. For more information go to [www.P65Warnings.ca.gov](http://www.P65Warnings.ca.gov).

# 2740D / 2748D / 2749D- Ultra High Pressure Waterblast Hose



## Features and Applications

- Small diameter, flexible hoses
- Ideal for tight routing applications
- Replaces high pressure steel tubing where flexibility and long lengths are important to minimize leak points
- Ultra high pressure waterblast lances for the construction and shipbuilding industries, common industrial cleaning applications, and high pressure tube cleaning in petrochemical and power plants
- Hydrodemolition
- Compression forming process (hydroforming) as a manufacturing procedure for truck and automotive industries
- Water Jet Cutting

## Markets

- Waterblast



## Certifications

- DIN EN1829-2 compliant

Part Number	Jacket Color	Nominal I.D.		Maximum O.D.		Maximum Working Pressure		Minimum Bend Radius		Weight		Fitting Series	
		DN	inch	mm	inch	mm	psi	bar	inch	mm	lbs/ft		kg/m
#													
2740D-03V35	Orange	5	3/16	4.8	0.52	13.3	40,600	2,800	7.87	200	0.32	0.47	2X
2748D-05V35	Orange	8	5/16	7.9	0.68	17.3	40,600	2,800	9.05	230	0.56	0.83	2X
2749D-05V35	Orange	8	5/16	7.9	0.68	17.3	43,645	3,010	9.05	230	0.56	0.83	2X
TOUGHJACKET™													
2740D-03V34/15	Orange	5	3/16	4.8	0.68	17.3	40,600	2,800	7.87	200	0.39	0.58	2X
2740D-05V34/17	Gray	8	5/16	7.8	0.84	21.3	36,230	2,500	7.87	200	0.63	0.94	2X
2748D-05V34/15	Orange	8	5/16	7.8	0.84	21.3	40,600	2,800	9.06	230	0.63	0.94	2X

## Construction

Core Tube: Polyoxymethylene

Reinforcement: Six spiral layers of maximum tensile steel wire

Cover: Polyamide

## Options

- Colors: ● Orange  
● Gray

## Temperature Range

+14°F to +158°F (-10°C to +70°C)

## Notes

- Assembly working pressure is dependent on the lowest rated component. Therefore, if fittings have a lower pressure rating than the hose, the working pressure of the fittings is the working pressure of the assembly.



**TOUGHJACKET**

Built in abrasion resistance eliminates the need for an additional PVC sleeve and lightens the hose by up to 16%.



### WARNING

This product can expose you to chemicals including Lead, which is known to the State of California to cause cancer and birth defects or other reproductive harm. For more information go to [www.P65Warnings.ca.gov](http://www.P65Warnings.ca.gov).

# 2740D / 2748D / 2749D- Fittings and Accessories

## Fittings

Technical details available in Section B.

Hose Part <b>#</b>	2740D-03V3x 2740D-03V34/15	2740D-05V3x 2740D-05V34/17 2748D-05V32/15 2748D-05V35 2749D-05V35
Fitting Part Numbers 	16Y2X-4-03 1922X-4-03 1AY2X-6-03 1AY2X-6-03C 1Y42X-4-03 1Y42X-4-03C 1Y42X-6-03 1Y42X-6-03C 1Y42X-9-03 1Y42X-9-03C	1AY2X-10-05-SA 1AY2X-8-05-SA 1Y42X-6-05 1Y42X-9-05 1Y42X-9-05-XLT

## Accessories

Technical details available in Section E.

Hose Part <b>#</b>	2740D-03V3x	2748D-05V3x 2749D-05V3x	2740D-05V3x	2740D-03V34/15	2740D-05V32/17	2748D-05V32/15
Accessory Part Numbers						
Heavy Duty Abrasion Cover	PVC-ORANGE -012	PVC-ORANGE -016	MHDC016	N/A	N/A	N/A
Cover Sleeves	510-A-500-12	412-400	216-200-18	* KL-2841-03	* KL-2841	* KL-2841
Containment Grip	MCG001SS MCGHS10-15	MCG001SS MCGHS15-20	MCG001SS MCGHS15-20	MCG001SS	MCGHS20-30	MCGHS20-30
Bend Stiffener	M55STIF4 M55STIF6	N/A	N/A	N/A	N/A	N/A
Bend Restrictor	MBR013-BLK	N/A	N/A	N/A	N/A	N/A
	412-400	N/A	N/A	N/A	N/A	N/A
Pressure Containment Shield and Sleeves	MHBS012	MHBS016	MHBS016	N/A	N/A	N/A
	412-400	412-400-16	412-400-16	N/A	N/A	N/A
Hose Stop	AH-05S	AH-07S	AH-07S	N/A	N/A	N/A

\* Cover sleeve required on TOUGHJACKET hose assemblies.



### WARNING

This product can expose you to chemicals including Lead, which is known to the State of California to cause cancer and birth defects or other reproductive harm. For more information go to [www.P65Warnings.ca.gov](http://www.P65Warnings.ca.gov).

# 2840D/2848D- Ultra High Pressure Waterblast Hose



## Features and Applications

- Ultra high pressure waterblast hose
- Compression forming process (hydroforming)
- Water Jet Cutting

## Markets



- Waterblast

## Certifications

- DIN EN1829-2 compliant except 2840D-03

Part Number	Jacket Color	Nominal I.D.			Maximum O.D.		Maximum Working Pressure		Minimum Bend Radius		Weight		Fitting Series
		DN	inch	mm	inch	mm	psi	bar	inch	mm	lbs/ft	kg/m	
#													
2840D-03V34	Red	5	3/16	4.8	0.59	15.0	58,000	4,000	7.87	200	0.43	0.63	2X
2840D-05V35	Orange	8	5/16	7.9	0.77	19.6	43,500	3,000	9.84	250	0.72	1.07	2X
2840D-08V37	Gray	12	1/2	12.7	1.18	29.9	36,250	2,500	13.78	350	1.68	2.50	WX
2848D-08V35	Orange	12	1/2	13.0	1.18	29.9	43,500	3,000	13.78	350	1.68	2.50	WX
TOUGHJACKET™													
2840D-03V36/14	Red	5	3/16	4.8	0.75	19.1	58,000	4,000	7.87	200	0.50	0.75	2X
2840D-05V36/15	Orange	8	5/16	7.9	0.93	23.6	43,500	3,000	9.84	250	0.82	1.22	2X

## Construction

Core Tube: Polyoxymethylene  
 Reinforcement: Eight spiral layers of maximum tensile steel wire  
 Cover: Polyamide

## Options

- Colors:
- Red
  - Orange
  - Gray

## Temperature Range

Temperature Range: +14°F to +158°F (-10°C to +70°C)

## Notes

- Assembly working pressure is dependent on the lowest rated component. Therefore, if fittings have a lower pressure rating than the hose, the working pressure of the fittings is the working pressure of the assembly.



Built in abrasion resistance eliminates the need for an additional PVC sleeve and lightens the hose by up to 16%.



### WARNING

This product can expose you to chemicals including Lead, which is known to the State of California to cause cancer and birth defects or other reproductive harm. For more information go to [www.P65Warnings.ca.gov](http://www.P65Warnings.ca.gov).

# 2840D/2848D- Fittings and Accessories

## Fittings

Technical details available in Section B.

Hose Part #	2840D-03V34 2840D-03V36/14	2840D-05V3x 2840D-05V36/15	2840D-08V3x 2848D-08V3x
Fitting Part Numbers 	16Y2X-4-03 1922X-4-03 1AY2X-6-03 1AY2X-6-03C 1Y42X-4-03 1Y42X-4-03C 1Y42X-6-03 1Y42X-6-03C 1Y42X-9-03	1AY2X-10-05-SA 1AY2X-8-05-SA 1Y42X-6-05 1Y42X-9-05 1Y42X-9-05-XLT 1AY2X-13-05-LB-SA	6Y4WX-16-8 6YMWX-12-8

## Accessories

Technical details available in Section E.

Hose Part #	2840D-03V34	2840D-05V3x	2840D-08V3x 2848D-08V3x	2840D-03V36/14	2840D-05V36/15
Accessory Part Numbers					
Heavy Duty Abrasion Cover	MHDC012	PVC-OR-AGNE-016	MHDC024	N/A	N/A
Cover Sleeves	510-A-500-12	412-400	220-200-22	* KL-2841-03	* KL-2841
Containment Grip	MGHS10-15	MGHS15-20	N/A	MGHS15-20	MGHS20-30
Bend Stiffener	M55STIF4 M55STIF6	N/A	N/A	N/A	N/A
Bend Restrictor	MBR013-BLK	N/A	N/A	N/A	N/A
	HPF-6	N/A	N/A	N/A	N/A
Pressure Containment Shield and Sleeves	MHBS012	MHBS016	N/A	N/A	N/A
	412-400	416-400-16	N/A	N/A	N/A
Hose Stop	AH-06S	AH-07S	N/A	N/A	N/A

\* Cover sleeve required on TOUGHJACKET™ hose assemblies.



### WARNING

This product can expose you to chemicals including Lead, which is known to the State of California to cause cancer and birth defects or other reproductive harm. For more information go to [www.P65Warnings.ca.gov](http://www.P65Warnings.ca.gov).

# 2849D- Ultra High Pressure Waterblast Hose



## Features and Applications

- Ultra-high pressure service for water jet cutting equipment with water only or with abrasive additives
- Replaces steel pipe where flexibility is important
- Compression forming (hydroforming)

## Markets

- Waterblast



## Certifications

- DIN EN1829-2 compliant

Part Number	Jacket Color	Nominal I.D.			Maximum O.D.		Maximum Working Pressure		Minimum Bend Radius		Weight		Fitting Series
		DN	inch	mm	inch	mm	psi	bar	inch	mm	lbs/ft	kg/m	
#													
2849D-05V34	Red	8	5/16	7.9	0.77	19.6	55,000	3,800	11.02	280	0.79	1.17	WX
TOUGHJACKET™													
2849D-05V36/14	Red	8	5/16	7.9	0.93	23.6	55,000	3,800	11.02	280	0.82	1.22	WX

## Construction

Core Tube: Polyoxymethylene  
 Reinforcement: Eight spiral layers of maximum tensile steel wire  
 Cover: Polyamide

## Options

Colors: Red

## Temperature Range

Temperature Range: +14°F to +158°F (-10°C to +70°C)

## Notes

- Assembly working pressure is dependent on the lowest rated component. Therefore, if fittings have a lower pressure rating than the hose, the working pressure of the fittings is the working pressure of the assembly.



Built in abrasion resistance eliminates the need for an additional PVC sleeve and lightens the hose by up to 16%.



### WARNING

This product can expose you to chemicals including Lead, which is known to the State of California to cause cancer and birth defects or other reproductive harm. For more information go to [www.P65Warnings.ca.gov](http://www.P65Warnings.ca.gov).



# 2849D- Fittings and Accessories

## Fittings

Technical details available in Section B.

Hose Part <b>#</b>	2849D-05V34 2849D-05V36/14
Fitting Part Numbers 	6YMWX-6-5-55 6Y4WX-9-5-55 6AYWX-10-5-55

## Accessories

Technical details available in Section E.

Hose Part	Accessory Part Numbers					
<b>#</b>	Heavy Duty Abrasion Cover	Cover Sleeves	Containment Grip	Pressure Containment Shield and Sleeves		Hose Stop
2849D-05V3X	MHDC016	216-200-18	MCGHS15-20	MHBS016	416-400-16	AH-07S
2849D-05V36/14	N/A	*KL-2841	MCGHS20-30	N/A	N/A	N/A

\* Cover sleeve required on TOUGHJACKET hose assemblies.



### WARNING

This product can expose you to chemicals including Lead, which is known to the State of California to cause cancer and birth defects or other reproductive harm. For more information go to [www.P65Warnings.ca.gov](http://www.P65Warnings.ca.gov).

# HCR High Collapse Resistant Hose



## Features and Applications

- Collapse resistant to 10,000 ft seawater at 1.5 design factor
- Flexible 316L stainless steel interlocking carcass
- Available in long continuous lengths
- Seamless polyamide 11 core tube
- Abrasion and seawater resistant polyurethane cover
- Compact bend radius
- Subsea Hydraulics
- BOP Stack
- Well Stimulation
- Hydraulic Flying Leads

## Markets

- Oil & Gas



Part Number	Jacket Color	Nominal I.D.		Maximum O.D.		Maximum Working Pressure		Minimum Bend Radius		Weight		Minimum Collapse Pressure		Collapse Pressure Rating per ISO13628-5 <sup>1,2</sup>		Fitting Series
		DN	inch mm	inch mm	psi bar	inch mm	lbs/ft kg/m	psi bar	psi bar							
#																
HCRV-8-BLU HCRV-8-YEL	Blue Yellow	8	1/2 12.7	1.04 26.4	5,000 34.5	4.0 102	0.45 0.67	6,600 456	4,400 303							HV
HCRV-16-BLU HCRV-16-YEL	Blue Yellow	16	1 25.4	1.83 46.4	5,000 34.5	11.8 300	1.44 2.15	6,600 456	4,400 303							HV

## Construction

Carcass: 316L SS

Core tube: Polyamide 11

Reinforcement: Aramid Fiber Braid

Cover: Polyurethane

## Options

Colors:

- Blue
- Yellow

## Temperature Range

-40°F to +131°F (-40°C to +55°C)

## Minimum Burst Pressure

Min. Burst Pressure is 4x Max. Working Pressure

## Fittings

HV Series - Constructed of 316 stainless steel

## Notes

- 1.5 design factor for collapse pressure per API 17E
- Contact the Parflex Division for installation depths greater than 10,000 ft.



### WARNING

This product can expose you to chemicals including Dichloromethane (Methylene chloride), which is known to the State of California to cause cancer, and Toluene, which is known to the State of California to cause birth defects or other reproductive harm. For more information go to [www.P65Warnings.ca.gov](http://www.P65Warnings.ca.gov).

# HCR - Fittings and Accessories

## Fittings

Technical details available in Section B.

Hose Part #	HCRV-8	HCRV-16
Fitting Part Numbers 	106HV-8-8C 19GHV-8-8C	106HV-16-16C 19GHV-16-16C

## Accessories

Technical details available in Section E.



### WARNING

This product can expose you to chemicals including Lead, which is known to the State of California to cause cancer and birth defects or other reproductive harm. For more information go to [www.P65Warnings.ca.gov](http://www.P65Warnings.ca.gov).

# 57CR “Sea Wolf” - High Collapse Resistant Hose



## Features and Applications

- Ultra-high abrasion resistant
- Suitable for marine (salt water) environment
- ISO 13628-5 “Specification for Subsea Production Control Umbilicals”, Section 7.9 Hose construction
- Smooth bore for improved flow rate and low pressure drop
- Ideal solution for subsea hydraulic lines that are not under constant system pressure
- Hose is not recommended for high pressure pneumatic service applications

## Markets

- Oil & Gas



Part Number	Jacket Color	Nominal I.D.		Maximum O.D.		Maximum Working Pressure		Minimum Bend Radius		Weight		Fitting Series	
		inch	mm	inch	mm	psi	bar	inch	mm	lbs/ft	kg/m		
#													
57CR-8-BLU	Blue	12	1/2	12.7	1.18	30	5,000	34.5	6.25	159	0.63	0.94	CR
57CR-8-YEL	Yellow	12	1/2	12.7	1.18	30	5,000	34.5	6.25	159	0.63	0.94	CR
57CR-16-BLU	Blue	25	1	25.4	2	50.8	5,000	34.5	10.75	273	1.46	2.17	CR
57CR-16-YEL	Yellow	25	1	25.4	2	50.8	5,000	34.5	10.75	273	1.46	2.17	CR

## Construction

Core Tube: Polyamide with stainless steel helix support

Reinforcement: High tensile strength aramid fiber

Cover: Polyurethane

## Options

Colors: Blue  
 Yellow

## Temperature Range

-40°F to +140°F (-40°C to +60°C) for petroleum, synthetic hydraulic oils, water and water-based hydraulic fluid

## Minimum Burst Pressure

Min. Burst Pressure is 4x Max. Working Pressure

## Notes

- Assembly working pressure is dependent on the lowest rated component. Therefore, if fittings have a lower pressure rating than the hose, the working pressure of the fittings is the working pressure of the assembly.



### WARNING

This product can expose you to chemicals including Titanium dioxide, which is known to the State of California to cause cancer. For more information go to [www.P65Warnings.ca.gov](http://www.P65Warnings.ca.gov).

# 57CR “Sea Wolf” - Fittings and Accessories

## Fittings

Technical details available in Section B.

Hose Part #	57CR-8	57CR-16
Fitting Part Numbers 	606CR-8-8C 66ACR-16-8C-SUBSEA* 66ACR-16-8C-SUBSEA-90* 66ACR-8-8C-SUBSEA* 66ACR-8-8C-SUBSEA-90*	606CR-16-16C 66ACR-16-16C-SUBSEA* 66ACR-16-16C-SUBSEA-90* 66ACR-24-16C-SUBSEA* 66ACR-24-16C-SUBSEA-90*

\*6A code on CR Series fittings are dual seal connections

## Accessories

Technical details available in Section E.



**WARNING**

This product can expose you to chemicals including Lead, which is known to the State of California to cause cancer and birth defects or other reproductive harm. For more information go to [www.P65Warnings.ca.gov](http://www.P65Warnings.ca.gov).

# HP- High Pressure Hose

## HP8- High Pressure Non-Conductive Hose



### Features and Applications

- Meets or exceeds SAE J517 for less than 50 microamps leakage under 75000 volts per foot\*
- Specially formulated thermoplastic elastomer core tube
- For use in high pressure hydraulic and pneumatic applications and can be used with lubricating oils
- Non-conductive version (HP8) used in aerial lift equipment
- High pressure tools
- Rigging jacks
- Test apparatus
- Oilfield pressure control devices
- Offshore oil applications

### Markets

- Oil & Gas
- Hydraulics



Part Number	Jacket Color	Nominal I.D.		Maximum O.D.		Maximum Working Pressure		Minimum Bend Radius		Weight		Fitting Series	
		DN	inch	inch	mm	psi	bar	inch	mm	lbs/ft	kg/m		
#													
HP-3	Blue	5	3/16	4.8	0.11	13.0	10,000	690	1.50	38	0.09	0.13	HP*
HP-4	Blue	6	1/4	6.4	0.25	14.7	10,000	690	2.50	64	0.11	0.16	HP*
HP-6	Blue	10	3/8	9.5	0.73	18.5	8,000	552	3.00	76	0.16	0.23	HP*
HP8-3*	Orange	5	3/16	4.8	0.11	13.0	10,000	690	1.50	38	0.09	0.13	HP*
HP8-4*	Orange	6	1/4	6.4	0.58	14.7	10,000	690	2.50	64	0.11	0.16	HP*
HP8-6*	Orange	10	3/8	9.5	0.73	18.5	8,000	552	3.00	76	0.16	0.23	HP*

Minimum hose assembly length: 20 in.

### Construction

Core Tube: Specially formulated thermoplastic elastomer

Reinforcement: High tensile strength aramid fiber

Cover: HP- perforated elastomeric cover  
HP8- non-perforated elastomeric cover

### Temperature Range

-40°F to +150°F (-40°C to +66°C) for petroleum, synthetic or water-based hydraulic fluids, pneumatic and gas service, and with some solvents and chemicals

### Notes

- HP8 is not qualified for pneumatic gas service applications
- Not recommended for water blast applications or for use in static discharge applications (i.e., airless paint spray)
- Assembly working pressure is dependent on the lowest rated component. Therefore, if fittings have a lower pressure rating than the hose, the working pressure of the fittings is the working pressure of the assembly
- HP/HP8 hose must be assembled at the factory or by a Parflex approved facility

### Options

- Colors: Blue  
 Orange



#### WARNING

This product can expose you to chemicals including Nickel Compounds, which is known to the State of California to cause cancer, and Toluene, which is known to the State of California to cause birth defects or other reproductive harm. For more information go to [www.P65Warnings.ca.gov](http://www.P65Warnings.ca.gov).

# HP / HP8- Fittings and Accessories

## Fittings

Technical details available in Section B.

Hose Part #	HP-3	HP-4	HP-6	HP8-3	HP8-4	HP8-6
Fitting Part Numbers 	101HP-4-3 101HP-6-3 106HP-4-3	101HP-4-4 101HP-6-4 106HP-4-4 106HP-6-4	101HP-6-6 106HP-6-6	101HP-4-3 101HP-6-3 106HP-4-3	101HP-4-3 101HP-4-4 101HP-6-4 106HP-4-4 106HP-6-4	101HP-6-6 106HP-6-6

## Required Accessories

Technical details available in Section E.

Hose Part #	Accessory Part Numbers
	High Pressure Guard Kit
HP-3	HPG3-12K HPG3-23K
HP-4	HPG4-12K HPG4-23K
HP-6	HPG6-12K HPG6-23K
HP8-3	HPG3-12K-ORG HPG3-23K-ORG
HP8-4	HPG4-12K-ORG HPG4-23K-ORG
HP8-6	HPG6-12K-ORG HPG6-23K-ORG



### WARNING

This product can expose you to chemicals including Lead, which is known to the State of California to cause cancer and birth defects or other reproductive harm. For more information go to [www.P65Warnings.ca.gov](http://www.P65Warnings.ca.gov).

# Black Eagle - 1-1/2" Oilfield Service Hose



## Features and Applications

- Up to 30% weight reduction in comparison to R13 rubber hoses - more than 70% in comparison to flexible pipe
- Lower bend radius when compared to composite hose
- Compact design - smaller O.D. than flexible pipe
- ColorGard™, an extra thick dual color Polyurethane sheath\*
- Long continuous lengths up to 1,000m without splicing (depending on hose type)
- Inner core has superior chemical resistance
- For oilfield services such as: cementing, water and gas injection hose, acidizing, mud circulation

## Markets



- Oil & Gas

Part Number	Jacket Color	Nominal I.D.		Maximum O.D.		Maximum Working Pressure		Minimum Bend Radius		Weight		Fitting Series	
		DN	inch	inch	mm	psi	bar	inch	mm	lbs/ft	kg/m		
#													
2640N-24V80-15K	Black	40	1-1/2	38.1	2.60	66.0	15,000	1,035	19.69	500	4.37	6.50	5X

## Construction

Core Tube: Polyamide 11, methanol washed

Reinforcement: 6 layers of high tensile steel wire

Cover: Extra thick dual layer polyurethane

## Options

Colors: ● Black w/ ColorGard™ red inner sheath

## Temperature Range

-40°F to +158°F (-40°C to +70°C),

15K hose can be used intermittently at +212°F (+100°C)

## Notes

- Assembly working pressure is dependent on the lowest rated component. Therefore, if fittings have a lower pressure rating than the hose, the working pressure of the fittings is the working pressure of the assembly.
- \* Polyflex ColorGard™ extra thick, dual color cover significantly reduces the risk of exposing the reinforcing wires. If the outer black cover has been abraded to the point that the "early warning" red inner cover can be seen, the hose needs to be changed out.



### WARNING

This product can expose you to chemicals including Lead, which is known to the State of California to cause cancer and birth defects or other reproductive harm. For more information go to [www.P65Warnings.ca.gov](http://www.P65Warnings.ca.gov).



# Black Eagle - Fittings and Accessories

## Fittings

Technical details available in Section B.

Hose Part <b>#</b>	2640N-24V80-15K
Fitting Part Numbers 	1HE5X-32-24C4462-KOP2 1HN5X-32-24C4462-KOP2

Other hub end fitting designs available.

## Accessories

Technical details available in Section E.

Hose Part	Accessory Part Numbers	
<b>#</b>	Containment Grip	Heat Shrink
2640N-24V80-15K	HS-24C-2640N	HDT4500-48A



**WARNING**

This product can expose you to chemicals including Lead, which is known to the State of California to cause cancer and birth defects or other reproductive harm. For more information go to [www.P65Warnings.ca.gov](http://www.P65Warnings.ca.gov).

# Black Eagle - 2" Oilfield Service Hose



## Features

- Up to 30% weight reduction in comparison to R13 rubber hoses - more than 70% in comparison to flexible pipe
- Lower bend radius when compared to composite hose
- Compact design - smaller O.D. than flexible pipe
- ColorGard™, an extra thick dual color Polyurethane sheath\*
- Long continuous lengths up to 1,000m without splicing (depending on hose type)
- Inner core has superior chemical resistance
- \*DNV Type Approval P 14038 according to API 7K and API 17J with BL Fittings
- For oilfield services such as: cementing, water and gas injection hose, acidizing, mud circulation

## Markets

- Oil & Gas



Part Number	Jacket Color	Nominal I.D.		Maximum O.D.		Maximum Working Pressure		Minimum Bend Radius		Weight		Fitting Series	
		inch	mm	inch	mm	psi	bar	inch	mm	lbs/ft	kg/m		
#													
2448N-32V80*	Black	50	2	50.8	3.17	80.5	5,000	345	20	508	5.71	8.50	5X
2580N-32V80*	Black	50	2	50.8	3.33	84.5	10,000	690	32	813	6.32	9.40	5X
2648N-32V80	Black	50	2	50.8	3.39	86.0	15,000	1,035	31	787	8.13	12.10	CX

## Construction

Core Tube: Polyamide 11, methanol washed

Reinforcement:

2448N – 4 spiral layers of high tensile steel wire

2580N – 4 spiral layers and 2 open spiral layers high tensile steel wire

2648N – 6 spiral layers of high tensile steel wire

Cover: Extra thick dual layer polyurethane

## Options

Colors: ● Black w/ ColorGard™ red inner sheath

## Temperature Range

-40°F to +158°F (-40°C to +70°C)

## Notes

- Assembly working pressure is dependent on the lowest rated component. Therefore, if fittings have a lower pressure rating than the hose, the working pressure of the fittings is the working pressure of the assembly.
- \* Polyflex ColorGard™ extra thick, dual color cover significantly reduces the risk of exposing the reinforcing wires. If the outer black cover has been abraded to the point that the “early warning” red inner cover can be seen, the hose needs to be changed out.



### WARNING

This product can expose you to chemicals including Lead, which is known to the State of California to cause cancer and birth defects or other reproductive harm. For more information go to [www.P65Warnings.ca.gov](http://www.P65Warnings.ca.gov).

# Black Eagle - Fittings and Accessories

## Fittings

Technical details available in Section B.

Hose Part #	2448N-32V80	2580N-32V80	2648N-32V80
Fitting Part Numbers 	66A5X-32-32TC3964 68K5X-33-32-17DSV3964-5K 68K5X-41-32-17DSV3964-5K 6HB5X-33-32-TC3964-5K 6HB5X-41-32-TC3964-5K 6HE5X-32-32-FLATTC 6HE5X-32-32-SEGTC 6HN5X-32-32-TC	68K5X-33-32-17DSV3964-10K 6HB5X-33-32-TC3964-10K 6HE5X-32-32-FLATTC 6HE5X-32-32-SEGTC 6HN5X-32-32-TC	1HECX-32-32-FLAT 1HNCX-32-32

Other hub end fitting designs available.

## Accessories

Technical details available in Section E.

Hose Part #	Accessory Part Numbers	
#	Containment Grip	Heat Shrink
2448N-32V80	MCGHS3295-SS	HDT4500-48A
2580N-32V80	MCGHS3295-SS	HDT4500-48A
2648N-32V80	MCGHS3295-SS	HDT4500-48A



**WARNING**

This product can expose you to chemicals including Lead, which is known to the State of California to cause cancer and birth defects or other reproductive harm. For more information go to [www.P65Warnings.ca.gov](http://www.P65Warnings.ca.gov).

# Black Eagle - 3" Oilfield Service Hose



## Features

- Up to 30% weight reduction in comparison to R13 rubber hoses – more than 70% in comparison to flexible pipe
- Lower bend radius when compared to composite hose
- Compact design – smaller O.D. than flexible pipe
- Colorard™, an extra thick dual color Polyurethane sheath\*
- Long continuous lengths up to 1,000m without splicing (depending on hose type)
- Inner core has superior chemical resistance
- DNV Type Approval P 14038 according to API 7K and API 17J
- For oilfield services such as: cementing, water and gas injection hose, acidizing, mud circulation

## Markets



- Oil & Gas

Part Number	Jacket Color	Nominal I.D.			Maximum O.D.		Maximum Working Pressure		Minimum Bend Radius		Weight		Fitting Series
		DN	inch	mm	inch	mm	psi	bar	inch	mm	lbs/ft	kg/m	
#													
2240N-48V80 <sup>1</sup>	Black	78	3	76.0	4.49	114.0	5,000	345	39.93	1000	7.73	11.50	TX
2440N-48V80 <sup>2</sup>	Black	78	3	76.0	4.80	122.0	10,000	690	43.31	1100	12.57	18.70	LX
2640N-48V80 <sup>2</sup>	Black	78	3	76.0	5.13	130.3	15,000	1,035	47.30	1200	18.48	27.50	5X

## Construction

Core Tube: Polyamide 11, methanol washed

Reinforcement:

2240N – 2 spiral layers of high tensile steel wire

2440N – 4 spiral layers high tensile steel wire

2640N – 6 spiral layers of high tensile steel wire

Cover: Extra thick dual layer polyurethane

## Options

Colors: ● Black w/ ColorGard™ red inner sheath

## Temperature Range

-40°F to +158°F (-40°C to +70°C), 2240N and 2440N can be used intermittently at +212°F (+100°C)

## Notes

- Assembly working pressure is dependent on the lowest rated component. Therefore, if fittings have a lower pressure rating than the hose, the working pressure of the fittings is the working pressure of the assembly.
- \* Polyflex ColorGard™ extra thick, dual color cover significantly reduces the risk of exposing the reinforcing wires. If the outer black cover has been abraded to the point that the “early warning” red inner cover can be seen, the hose needs to be changed out.



### WARNING

<sup>1</sup>This product can expose you to chemicals including Titanium dioxide, which is known to the State of California to cause cancer. <sup>2</sup>This product can expose you to chemicals including Lead, which is known to the State of California to cause cancer and birth defects or other reproductive harm. For more information go to [www.P65Warnings.ca.gov](http://www.P65Warnings.ca.gov).

# Black Eagle - Fittings and Accessories

## Fittings

Technical details available in Section B.

Hose Part #	2240N-48V80	2440N-48V80	2640N-48V80
Fitting Part Numbers 	1HETX-48-48 1HETX-48-48-FLAT 1HNTX-48-48	1HELX-48-48 1HELX-48-48-FLAT 1HNLX-48-48	1HE5X-48-48 1HE5X-48-48-FLAT 1HN5X-48-48

## Accessories

Technical details available in Section E.



**WARNING**

This product can expose you to chemicals including Lead, which is known to the State of California to cause cancer and birth defects or other reproductive harm. For more information go to [www.P65Warnings.ca.gov](http://www.P65Warnings.ca.gov).

# Black Eagle Light - Cementing Hose



## Features

- Abrasive applications, such as cementing
- Significantly higher abrasion resistance than common elastomer materials — longer service life and less contamination in cement slurry
- Easy visualization of core tube erosion— more efficient product inspection and reduced unscheduled downtime
- Lighter weight and smaller O.D. than common 4-layer constructions - faster and easier deployment

## Markets

- Oil & Gas



Part Number	Jacket Color	Nominal I.D.		Maximum O.D.		Maximum Working Pressure		Minimum Bend Radius		Weight		Fitting Series	
		inch	mm	inch	mm	psi	bar	inch	mm	lbs/ft	kg/m		
#													
2240N-32V10	Black	50	2	50.8	2.70	68.5	3,000	207	19.69	500	2.96	4.40	S6*
2248N-32V10	Black	50	2	50.8	2.70	68.5	5,000	345	19.69	500	2.96	4.40	S6*

## Construction

Core Tube: Polyamide 11, two-layer core tube

Reinforcement: Two closed spiral layers of high tensile steel wire

Cover: Polyurethane

## Options

Colors: ● Black

## Temperature Range°

-40°F to +212°F (-40°C to +100°C)

## Notes

- Assembly working pressure is dependent on the lowest rated component. Therefore, if fittings have a lower pressure rating than the hose, the working pressure of the fittings is the working pressure of the assembly.
- \* Fittings are not for use subsea. For subsea applications, see traditional **Black Eagle** product series.



### WARNING

This product can expose you to chemicals including Titanium dioxide, which is known to the State of California to cause cancer. For more information go to [www.P65Warnings.ca.gov](http://www.P65Warnings.ca.gov).

# Black Eagle Light - Fittings and Accessories

## Fittings

Technical details available in Section B.

Hose Part <b>#</b>	2240N-32V10	2448N-32V10
Fitting Part Numbers  	Offshore*: 1HES6-32-32-FLAT-SC 1HNS6-32-32-SC  Onshore: 1HES6-32-32-FLAT 1HNS6-32-32	Offshore*: 1HES6-32-32-FLAT-SC 1HNS6-32-32-SC  Onshore: 1HES6-32-32-FLAT 1HNS6-32-32

\*Fittings are not for use subsea. For subsea applications, see traditional **Black Eagle** product series.

## Accessories

Technical details available in Section E.



**WARNING**

This product can expose you to chemicals including Lead, which is known to the State of California to cause cancer and birth defects or other reproductive harm. For more information go to [www.P65Warnings.ca.gov](http://www.P65Warnings.ca.gov).

# Golden Eagle - Chemical Injection and Acidizing Hose



## Features and Applications

- ColorGard™, an extra thick dual color polyurethane sheath\*
- Long continuous lengths up to 1,000m without splicing (depending on hose type)
- Inner core has superior chemical resistance
- Compact design – smaller O.D. than flexible pipe
- Up to 30% weight reduction in comparison to R13 rubber hoses – more than 70% in comparison to flexible pipe
- Lower bend radius when compared to composite hose
- Water and chemical injection hose
- Acidizing
- Not recommended for gas applications

## Markets

- Oil & Gas



Part Number	Jacket Color	Nominal I.D.			Maximum O.D.		Maximum Working Pressure		Minimum Bend Radius		Weight		Fitting Series
		DN	inch	mm	inch	mm	psi	bar	inch	mm	lbs/ft	kg/m	
#													
2640M-24V88	Gold	40	1-1/2	38.1	2.78	70.5	10,000	690	19.69	500	4.84	7.20	5X
2580M-32V88	Gold	50	2	50.8	3.33	84.5	10,000	690	31.50	800	6.32	9.40	5X

## Construction

Core Tube: Polyamide 11,  
methanol washed

Reinforcement:

2640M – 6 spiral layers of high  
tensile steel wire

2580M – 4 spiral layers and two  
open spiral layers of high tensile  
steel wire

Cover: Extra thick dual layer  
polyurethane

## Options

Colors: Gold w/ ColorGard™  
red inner sheath

## Temperature Range

-40°F to +158°F (-40°C to +70°C);

2640M short term up to +212°F (+100°C)

## Notes

- Assembly working pressure is dependent on the lowest rated component. Therefore, if fittings have a lower pressure rating than the hose, the working pressure of the fittings is the working pressure of the assembly.
- \* Polyflex ColorGard™ extra thick, dual color cover significantly reduces the risk of exposing the reinforcing wires. If the outer black cover has been abraded to the point that the “early warning” red inner cover can be seen, the hose needs to be changed out.



### WARNING

This product can expose you to chemicals including Lead, which is known to the State of California to cause cancer and birth defects or other reproductive harm. For more information go to [www.P65Warnings.ca.gov](http://www.P65Warnings.ca.gov).



# Golden Eagle - Fittings and Accessories

## Fittings

Technical details available in Section B.

Hose Part #	2640M-24V88	2580M-32V88
Fitting Part Numbers 	1HE5X-32-24C4462-FLATTC 1HN5X-32-24C4462-TC	68K5X-33-32-17DSV3964-10K 6HB5X-33-32-TC3964-10K 6HE5X-32-32-FLATTC 6HE5X-32-32-SEGTC 6HN5X-32-32-TC

Other hub end fitting designs available.

## Accessories

Technical details available in Section E.



**WARNING**

This product can expose you to chemicals including Lead, which is known to the State of California to cause cancer and birth defects or other reproductive harm. For more information go to [www.P65Warnings.ca.gov](http://www.P65Warnings.ca.gov).

# ChemJec - Long-length Umbilical Hose



## Features

- Excellent chemical resistance
- Medium pressure, high temperature, low volumetric expansion hose
- Withstands high pressure cycles with no signs of stress cracking
- Meets or exceeds the performance requirements of ISO 13628-5
- Long-length subsea umbilical hose
- Not recommended for gas applications

## Markets

- Oil & Gas



Part Number	Jacket Color	Nominal I.D.			Maximum O.D.		Maximum Working Pressure		Minimum Bend Radius		Weight		Fitting Series
		DN	inch	mm	inch	mm	psi	bar	inch	mm	lbs/ft	kg/m	
#													
2440M-04V38	Gold	6	1/4	6.4	0.52	13.1	12,500	875	5.90	150	0.21	0.31	8X
2440M-05V38	Gold	8	5/16	7.9	0.64	16.2	10,000	690	6.88	175	0.33	0.49	LX
2440M-06V38	Gold	10	3/8	9.5	0.77	19.5	15,000	1,035	7.48	190	0.49	0.73	LX
2440M-08V38	Gold	12	1/2	12.7	0.89	22.7	10,000	690	7.87	200	0.63	0.94	LX
2448M-04V38	Gold	6	1/4	6.4	0.54	13.7	15,000	1,035	9.06	230	0.26	0.38	UX
2448M-05V38	Gold	8	5/16	7.9	0.64	16.3	15,000	1,035	9.06	230	0.35	0.52	LX
2448M-06V38	Gold	10	13/32	10.2	0.79	20.1	10,000	690	7.87	200	0.56	0.83	UX
2640M-08V38	Gold	12	1/2	12.7	0.97	24.7	15,000	1,035	11.42	290	0.90	1.34	5X

## Construction

Core Tube: Proprietary specification, based on fluoropolymer technology

### Reinforcement:

2440M / 2448M – 4 closed spiral layers of high tensile steel wire  
2640M – 6 closed spiral layers of high tensile steel wire

Cover: Polyamide 12

## Options

Colors: Gold

## Temperature Range

-40°F to +212°F (-40°C to +100°C)

## Notes

- Not recommended for gas applications
- Assembly working pressure is dependent on the lowest rated component. Therefore, if fittings have a lower pressure rating than the hose, the working pressure of the fittings is the working pressure of the assembly.



### WARNING

This product can expose you to chemicals including Lead, which is known to the State of California to cause cancer and birth defects or other reproductive harm. For more information go to [www.P65Warnings.ca.gov](http://www.P65Warnings.ca.gov).

## Fittings

Technical details available in Section B.

Hose Part #	2440M-04V38	2440M-05V38	2440M-06V38
Fitting Part Numbers 	1018X-4-04C 1018X-6-04C 1028X-4-04C 1068X-4-04C 1068X-6-04C 1AY8X-6-04C	6AYLX-8-5C-M-SUBSEA 106LX-6-05C 1AYLX-8-05C	6AYLX-8-6C-SUBSEA 106LX-6-06C-M-SUBSEA 106LX-8-06C-M-SUBSEA
	2440M-08V38	2448M-04V38	2448M-05V38
	106LX-8-08C-M-SUBSEA 1Y2LX-12-08C-M-SUBSEA	101UX-6-04C 1AYUX-6-04C 1Y2UX-6-04C	6AYLX-8-5C-M-SUBSEA
	2448M-06V38	2640M-08V38	
	1AYUX-8-06C 1Y2UX-9-06C	1AY5X-11-08C-M-SUBSEA 1Y25X-12-08C-M-SUBSEA 1Y25X-9-08C-M-SUBSEA	

## Accessories

Technical details available in Section E.



**WARNING**

This product can expose you to chemicals including Lead, which is known to the State of California to cause cancer and birth defects or other reproductive harm. For more information go to [www.P65Warnings.ca.gov](http://www.P65Warnings.ca.gov).



# Fittings

Permanent / Crimp Fittings  
Field Attachable / Reusable  
Polyflex-Lok



# Table of Contents

## Introduction

End Fitting Nomenclature.....	B-4
Fitting Configuration Chart.....	B-6
How to Read the Fittings Section .....	B-9

## Fittings by Series

2X Series .....	B-10
3X Series .....	B-12
5X Series .....	B-14
8X Series .....	B-16
9X Series.....	B-24
AX Series .....	B-26
BL Series .....	B-27
BS Series.....	B-29
CR Series.....	B-31
CX Series.....	B-33
E3/E4 Series .....	B-34
EX Series .....	B-37
HV Series.....	B-40
HX Series.....	B-41
JX Series .....	B-42
KY Series.....	B-43
LX Series .....	B-45
NX Series.....	B-57

# Table of Contents

## Fittings by Series (cont.)

RX Series.....	B-60
TX Series.....	B-61
UX Series.....	B-64
WX Series.....	B-65
Black Eagle Fittings.....	B-67

## Polyflex-Lok

Polyflex-Lok Components.....	B-74
------------------------------	------

Hose  
A

Fittings  
B

Adapters & Valves  
C

Quick Couplings  
D

Accessories  
E

General Technical  
F

# Fitting Part Number Nomenclature

Hose  
A

Fittings  
B

Adapters & Valves  
C

Quick Couplings  
D

Accessories  
E

General Technical  
F



**6Y4LX-9-3C**

**6**

### 1. Design Type

1 = German-designed end fitting  
6 = US-designed end fitting  
2 = Reusable style end fittings

**Y4**

**LX**

### 2. Connection Type

01	=	NPT - Male
02	=	NPT - Female
06	=	JIC 37° Flare - Female
5Y	=	Medium Pressure Female - Swivel
6A	=	Code 62
6Y	=	High Pressure Female - Swivel
8K	=	API Hub with Flange
92	=	BSP Female - Swivel
9G	=	Straight Dual Seal
AY	=	Type "M" Female - Swivel
C3 / C9	=	METRIC Female - Swivel
D9	=	BSP Rigid - Male
HB	=	API Hub
HE	=	2" Hammer Union, Cone w/ Wing Nut - Male
HN	=	2" Hammer Union, Cone Threaded End w/Seal- Female
HY	=	Waterblast Nozzle - Female
MB	=	STECKO
TU	=	Tube Stub Fitting
Y2	=	Medium Pressure - Tube Nipple
Y4	=	High Pressure - Tube Nipple
YH	=	Waterblast Nozzle - Male
YM	=	Waterblast Nozzle - Male Metric

### 3. Fitting Series Designation

For a complete list, see index, page B-2 ie. LX



# Fitting Part Number Nomenclature

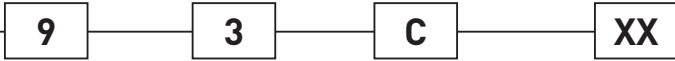

4. Connection Type
These two digits will indicate the SIZE of connection - End 1 and End 2.
<b>JIC/Type M</b>
01 = 1/4" -28 UNF
02 = 5/16" - 24 UNF
03 = 3/8" -24 UNF
04 = 7/16" - 20 UNF
05 = 1/2" - 20 UNF
06 = 9/16" -18 UNF
07 = 5/8" - 18 UNF
08 = 3/4" -16 UNF
10 = 7/8" - 14 UNF
11 = 1" - 12 UNF
12 = 1-1/16" - 12 UNF
13 = 1-1/8" - 12 UNF
15 = 1-1/4" - 12 UNF
16 = 1-5/16" - 12 UNF
17 = 1-3/8" - 12 UNF
19 = 1-1/2" - 12 UNF
20 = 1-5/8" - 12 UNF
<b>BSP</b>
02 = G 1/8" - 28
04 = G 1/4" - 19
06 = G 3/8" - 19
08 = G 1/2" - 14
<b>NPTF</b>
01 = 1/16" - 27
02 = 1/8" - 27
04 = 1/4" - 18
06 = 3/8" - 18
08 = 1/2" - 14
12 = 3/4" - 14
16 = 1" - 11-1/2
20 = 1-1/4" -11-1/2
24 = 1-1/2" -11-1/2
32 = 2" - 11-1/2
<b>MP &amp; HP Tube</b>
(Sized by nominal tube O.D.)
04 = 1/4" - 28
06 = 3/8" - 24
09 = 9/16" -18
12 = 3/4" - 16
16 = 1" - 14

5. Hose Size
1/8" -02
5/32" -02A
3/16" -03
1/4" -04
5/16" -05
3/8" -06
1/2" -08
3/4" -12
1" -16
2" -32

6. Fitting Material
C = Stainless steel
Blank = Carbon steel
Any other materials will be noted in the Fitting section

Specialty Codes
-PL = Prolance
-LH = Left Hand
-W = Waterblast
-411 = Non std drop
-4662 = Duplex steel
-55 = Specific psi
-HCL = 4340 steel
-SA = SAE hex
-SD = Nitronic 50
-SL = Short nipple
-XLT = Extra long nipple

[Hose Part Numbers - Nomenclature](#)—page A-8

[Hose Assembly Part Numbers - Nomenclature](#)—page A-10

Hose  
A

Fittings  
B

Adapters & Valves  
C

Quick Couplings  
D

Accessories  
E

General Technical  
F

# Fitting Designation Descriptions

Hose  
A



**B** Fittings

C Adapters & Valves

D Quick Couplings

E Accessories

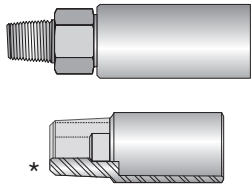
F General Technical

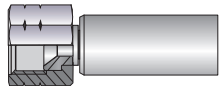
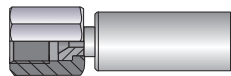
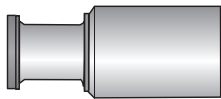
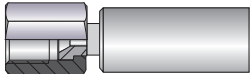
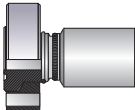
Fitting	Fitting Description	Fitting Designation
	<p><b>National Pipe Tapered (NPT) - Male</b> * Prolance</p>	01
	<p><b>National Pipe Tapered (NPT) - Female</b></p>	02
	<p><b>JIC 37° Flare - Female</b></p>	06
	<p><b>Medium Pressure Female - Swivel</b></p>	5Y
	<p><b>Code 62</b></p>	6A
	<p><b>High Pressure Female Swivel</b></p>	6Y
	<p><b>API Hub with Flange</b></p>	8K

# Fitting Designation Descriptions

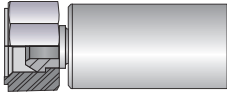
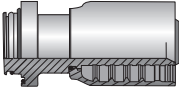
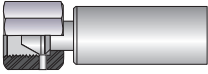
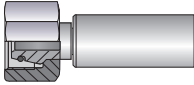
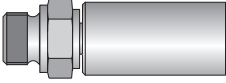
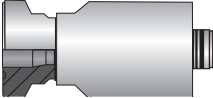
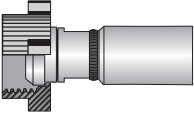
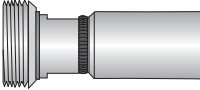
Fitting	Fitting Description	Fitting Designation
	BSP Female - Swivel	92
	Straight Dual Seal	9G
	Type "M" Female - Swivel	AY
	Metric Female - Swivel	C3 or C9
	BSP Rigid - Male	D9
	API Hub	HB
	Hammer Union (Male) Cone with Wing Nut	HE
	Hammer Union (Female) Cone Threaded End with Seal	HN

Hose  
A

**Fittings**  
B

Adapters & Valves  
C

Quick Couplings  
D

Accessories  
E

General Technical  
F

# Fitting Designation Descriptions

Hose  
A



**B**  
Fittings

C  
Adapters & Valves

D  
Quick Couplings

E  
Accessories

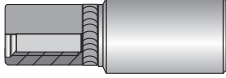
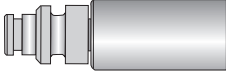
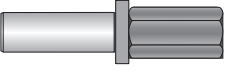
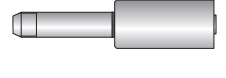
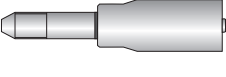
F  
General Technical

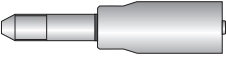
Fitting	Fitting Description	Fitting Designation
	Waterblast Nozzle - Female	HY
	Stecko - Male	MB
	Tube Stub Fitting	TU
	Medium Pressure Tube Nipple	Y2
	High Pressure Tube Nipple	Y4
	Waterblast Nozzle - Male	YH
	Waterblast Nozzle - Male Metric	YM

# How to Read the Fittings Section

1



2

3

4

5

6

Part Number	Thread Size	A Overall Length		B Cutoff Allowance		Hex		Max. Working Pressure	
		inch	mm	inch	mm	inch	mm	psi	bar
#									
6AYHX-6-3C	9/16"-18	3.20	81	1.40	36	0.68	17	40,600	2,800

## 1. Part Number

The fitting part number gives the connection type and size of the fitting, as well as, the hose series and hose size the fitting is intended for (see part number breakdown on pg. B-4).

## 2. Thread Size

UNF threads will contain a number indicating the nominal diameter of the thread, followed by the pitch measured in threads per inch. Any other thread form will be identified in the thread size measurement (i.e. NPT, BSP, Metric, etc.).

## 3. Overall Fitting Length

This measurement indicates the total length of fitting from end to end.

## 4. Cutoff Allowance

End fitting dimension from the seating surface to the fitting hose stop. This dimension added to the length of the cut hose will yield the over-all length(OAL) of the hose assembly.

## 5. Hex Size

This is the dimension of the hex across opposing flats.

## 6. Maximum Working Pressure

Maximum pressure at which the fitting should be operated. Most fittings are rated for the full working pressure of the hose. Fittings with maximum pressures that differ from the hose working pressure will be called out.

**Note:** The working pressure of a hose assembly is dependent upon the lowest rated component of that assembly. For example, if a hose is rated to 40K psi, but the fittings are rated to 15K psi, the working pressure of that assembly is 15K psi.

# 2X Series Fittings

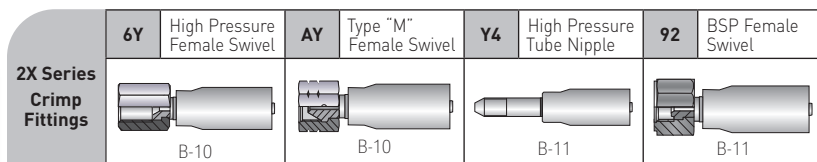

## 16Y2X- High Pressure Female Swivel

Material: Nipple - Very high strength stainless steel  
Shell - Zinc-plated high strength carbon steel

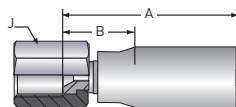

Part Number	Nominal I.D.				Thread Size	A Overall Length		B Cutoff Allowance		J Hex		Maximum Working Pressure*	
	DN	Size	inch	mm		inch	mm	inch	mm	inch	mm	psi	bar
#	⊙				⌀					⬡		↻	
16Y2X-4-025	4	-025	5/32	4.0	9/16"-18	2.99	76	0.90	23	0.875	22	—	—
16Y2X-4-03	5	-03	3/16	4.8	9/16"-18	2.99	76	0.90	23	0.875	22	—	—

\* Fitting is rated to the full working pressure of the hose

## 1AY2X- Type "M" Female Swivel

Material: Nipple - Very high strength stainless steel  
Shell - Zinc-plated high strength carbon steel  
C - Stainless steel

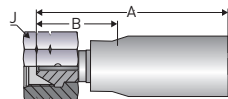

Part Number	Nominal I.D.				Thread Size	A Overall Length		B Cutoff Allowance		J Hex		Maximum Working Pressure*	
	DN	Size	inch	mm		inch	mm	inch	mm	inch	mm	psi	bar
#	⊙				⌀					⬡		↻	
1AY2X-6-025	4	-025	5/32	4.0	9/16"-18	2.40	61	0.94	24	0.875	22	—	—
1AY2X-6-025C	4	-025	5/32	4.0	9/16"-18	2.40	61	0.94	24	0.875	22	—	—
1AY2X-6-03	5	-03	3/16	4.8	9/16"-18	3.58	91	1.50	38	0.875	22	—	—
1AY2X-6-03C	5	-03	3/16	4.8	9/16"-18	3.58	91	1.50	38	0.875	22	—	—
1AY2X-8-05-SA	8	-05	5/16	7.9	3/4"-16	3.58	91	1.50	38	1.000	25	—	—
1AY2X-10-05-SA	8	-05	5/16	7.9	7/8"-14	3.58	91	1.50	38	1.250	32	—	—
1AY2X-13-05-LB-SA	8	-05	5/16	7.9	1-1/8"-12	3.58	91	1.50	38	1.375	5	—	—

\*Fitting is rated to the full working pressure of the hose



**WARNING**

This product can expose you to chemicals including Lead, which is known to the State of California to cause cancer and birth defects or other reproductive harm. For more information go to [www.P65Warnings.ca.gov](http://www.P65Warnings.ca.gov).

# 2X Series Fittings

## 1Y42X- High Pressure Tube Nipple

Material: Nipple - Very high strength stainless steel  
 Shell - Zinc-plated high strength carbon steel  
 C - Stainless steel

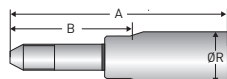

Part Number	Nominal I.D.				Thread Size	A Overall Length		B Cutoff Allowance		R Diameter		Maximum Working Pressure*	
	DN	Size	inch	mm		inch	mm	inch	mm	inch	mm	psi	bar
#													
1Y42X-4-025	4	-025	5/32	4.0	1/4" - 28 LH	3.50	88	1.97	50	0.615	16	—	—
1Y42X-4-025C	4	-025	5/32	4.0	1/4" - 28 LH	3.50	88	1.97	50	0.615	16	—	—
1Y42X-6-025	4	-025	5/32	4.0	3/8" - 24 LH	3.90	98	2.17	55	0.615	16	—	—
1Y42X-6-025C	4	-025	5/32	4.0	3/8" - 24 LH	3.90	98	2.17	55	0.615	16	—	—
1Y42X-4-03	5	-03	3/16	4.8	1/4" - 28 LH	4.60	116	2.48	63	0.732	18.6	—	—
1Y42X-4-03C	5	-03	3/16	4.8	1/4" - 28 LH	4.60	116	2.48	63	0.732	18.6	—	—
1Y42X-6-03	5	-03	3/16	4.8	3/8" - 24 LH	4.60	116	2.28	58	0.750	19	—	—
1Y42X-6-03C	5	-03	3/16	4.8	3/8" - 24 LH	4.60	116	2.28	58	0.750	19	—	—
1Y42X-9-03	5	-03	3/16	4.8	9/16" - 18 LH	4.60	116	2.48	63	0.750	19	—	—
1Y42X-6-05	8	-05	5/16	7.9	3/8" - 24 LH	4.60	116	2.48	63	0.905	23	—	—
1Y42X-9-05	8	-05	5/16	7.9	9/16" - 18 LH	4.90	125	2.48	63	0.905	23	—	—
1Y42X-9-05-XLT	8	-05	5/16	7.9	9/16" - 18 LH	5.39	137	3.39	86	0.905	23	—	—

\* Fitting is rated to the full working pressure of the hose

## 1922X- BSP Female Swivel

Material: Nipple - Very high strength stainless steel  
 Shell - Zinc-plated high strength carbon steel

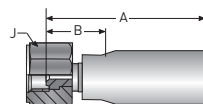

Part Number	Nominal I.D.				Thread Size	A Overall Length		B Cutoff Allowance		J Hex		Maximum Working Pressure*	
	DN	Size	inch	mm		inch	mm	inch	mm	inch	mm	psi	bar
#													
1922X-4-03	5	-03	3/16	4.8	G 1/4" - 19	3.11	79	1.02	26	0.875	22	—	—

\* Fitting is rated to the full working pressure of the hose



### WARNING

This product can expose you to chemicals including Lead, which is known to the State of California to cause cancer and birth defects or other reproductive harm. For more information go to [www.P65Warnings.ca.gov](http://www.P65Warnings.ca.gov).

# 3X Series Fittings

	<b>06</b>	JIC 37° Flare - Female	<b>92</b>	BSP Swivel - Female	<b>C9</b>	Metric Swivel - Female
<b>3X Series Crimp Fittings</b>		B-12		B-12		B-13

## 1063X- JIC 37° Female Flare

Material: Nipple - Stainless steel  
Shell - Stainless steel  
Nut - Stainless steel

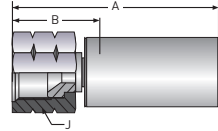

Part Number	Nominal I.D.				Thread Size	A Overall Length		B Cutoff Allowance		J Hex		Maximum Working Pressure*	
#													
	DN	Size	inch	mm		inch	mm	inch	mm	inch	mm	psi	bar
1063X-6-06C	10	-06	3/8	9.5	9/16"-18	2.72	69	1.30	33	0.870	22	10,000	690
1063X-8-06C	10	-06	3/8	9.5	3/4" - 16	2.85	73	1.28	33	1.000	24	10,000	690

## 1923X- BSP Female Swivel

Material: Nipple - Stainless steel  
Shell - Stainless steel  
Nut - Stainless steel

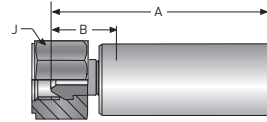

Part Number	Nominal I.D.				Thread Size	A Overall Length		B Cutoff Allowance		J Hex		Maximum Working Pressure*	
#													
	DN	Size	inch	mm		inch	mm	inch	mm	inch	mm	psi	bar
1923X-8-06C	10	-06	3/8	9.5	G 1/2" - 14	2.60	66	0.87	22	1.180	30	—	—

\* Fitting is rated to the full working pressure of the hose



### WARNING

This product can expose you to chemicals including Lead, which is known to the State of California to cause cancer and birth defects or other reproductive harm. For more information go to [www.P65Warnings.ca.gov](http://www.P65Warnings.ca.gov).



# 3X Series Fittings

## 1C93X- Metric Swivel - Female

Material: Nipple - Stainless steel  
 Shell - Stainless steel  
 Nut - Stainless steel

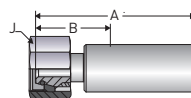

Part Number	Nominal I.D.				Thread Size	A Overall Length		B Cutoff Allowance		J Hex		Maximum Working Pressure*	
#													
	DN	Size	inch	mm		inch	mm	inch	mm	inch	mm	psi	bar
1C93X-14-06C	10	-06	3/8	9.5	M 22 x 1.5	2.95	75	1.20	30	1.180	30	—	—
1C93X-16-06C	10	-06	3/8	9.5	M 24 x 1.5	3.50	88	1.35	34	1.180	30	—	—



\* Fitting is rated to the full working pressure of the hose



### WARNING

This product can expose you to chemicals including Lead, which is known to the State of California to cause cancer and birth defects or other reproductive harm. For more information go to [www.P65Warnings.ca.gov](http://www.P65Warnings.ca.gov).





# 5X Series Fittings

<b>AY</b>	Type "M" Female Swivel	<b>C9</b>	Metric Female Swivel	<b>Y2</b>	Medium Pressure Tube Nipple
<b>5X Series Crimp Fittings</b>					
	B-14	B-14	B-15		

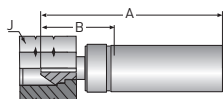
## 6AY5X- Type "M" Female Swivel

Material: Nipple - Very high strength stainless steel  
 SD / SUBSEA - High strength corrosion-resistant stainless steel  
 Shell and Nut - Stainless steel







Part Number	Nominal I.D.				Thread Size	A Overall Length		B Cutoff Allowance		J Hex		Maximum Working Pressure*	
	DN	Size	inch	mm		inch	mm	inch	mm	inch	mm	psi	bar
<b>#</b>													
6AY5X-11-8C	12	-08	1/2	12.7	1" - 12	4.25	108	1.72	44	1.250	32	—	—
6AY5X-16-12C	20	-12	3/4	19	1-5/16" - 12	4.26	108	1.52	39	1.500	38	—	—
6AY5X-16-12C-INC725	20	-12	3/4	19	1-5/16" - 12	4	102	1.25	32	1.500	38	—	—
6AY5X-11-8C-SUBSEA	12	-08	1/2	12.7	1" - 12	4.22	107	1.98	50	1.250	32	—	—
1AY5X-11-08C-M-SUBSEA	12	-08	1/2	12.7	1"-12	4.42	112	1.87	47	1.250	32	—	—

\* Fitting is rated to the full working pressure of the hose

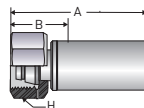
## 6C95X- Metric Female Swivel

Material: Nipple - Very high strength stainless steel  
 Shell - Stainless steel  
 Nut - Carbon steel, zinc-plated



Part Number	Nominal I.D.				Thread Size	A Overall Length		B Cutoff Allowance		H Hex		Maximum Working Pressure*	
	DN	Size	inch	mm		inch	mm	inch	mm	inch	mm	psi	bar
<b>#</b>													
6C95X-25-12C	20	-12	3/4	19.0	M 36 x 2	4.37	111	1.60	41	1.810	46	—	—

\* Fitting is rated to the full working pressure of the hose



### WARNING

This product can expose you to chemicals including Lead, which is known to the State of California to cause cancer and birth defects or other reproductive harm. For more information go to [www.P65Warnings.ca.gov](http://www.P65Warnings.ca.gov).

# 5X Series Fittings

## 1Y25X/6Y25X- Medium Pressure Tube Nipple

Material: Nipple - Very high strength stainless steel  
 SUBSEA - High strength corrosion resistant stainless steel  
 Shell - Stainless steel

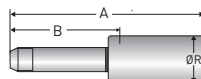

Part Number	Nominal I.D.				Thread Size	A Overall Length		B Cutoff Allowance		R Diameter		Maximum Working Pressure	
	DN	Size	inch	mm		inch	mm	inch	mm	inch	mm	psi	bar
#													
6AY5X-16-12C-INC725	20	-12	3/4	19.0	1"-14 LH	7.17	182	5.07	129	1.500	38	20,000	1,380
6Y25X-16-12C-SL	20	-12	3/4	19.0	1"-14 LH	4.83	123	2.73	69	1.690	43	20,000	1,380
1Y25X-9-08C-M-SUBSEA	12	-08	1/2	12.7	9/16"-18 LH	6.69	174	4.31	109	1.339	34	20,000	1,380
1Y25X-12-08C-M-SUBSEA	12	-08	1/2	12.7	3/4"-16 LH	7.25	184	4.70	119	1.339	34	20,000	1,380

Hose

A

Fittings

B

Adapters & Valves

C

Quick Couplings

D

Accessories

E

General Technical









F

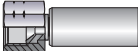

### WARNING

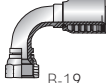
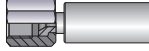
This product can expose you to chemicals including Lead, which is known to the State of California to cause cancer and birth defects or other reproductive harm. For more information go to [www.P65Warnings.ca.gov](http://www.P65Warnings.ca.gov).

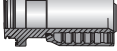
# 8X Series Fittings

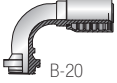
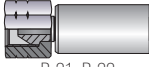
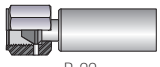
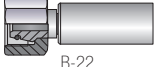
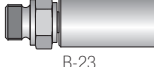
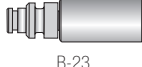
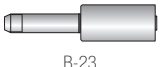
<b>2X Series Crimp Fittings</b>	<b>01</b> NPT Male	<b>02</b> NPT - Female	<b>06</b> JIC 37° Flare - Female	<b>37</b> 45° JIC Subsea
	 B-16	 B-17	 B-18	 B-19
	<b>39</b> 90° JIC Subsea	<b>5Y</b> Med. Pressure Swivel - Female	<b>92</b> BSP Female Swivel	<b>9G</b> Straight Dual Seal Subsea
	 B-19	 B-21	 B-20	 B-19
	<b>9M</b> 45° Dual Seal Subsea	<b>9W</b> 90° Dual Seal Subsea	<b>AY</b> Type M Swivel - Female	<b>C3</b> Metric Swivel - Female
	 B-20	 B-20	 B-21, B-22	 B-22
<b>C9</b> Metric Swivel - Female	<b>D9</b> BSP Rigid - Male	<b>MB</b> Stecko	<b>Y2</b> Med. Pressure - Male	
 B-22	 B-23	 B-23	 B-23	

## 6018X- NPT Male

**Material:** Nipple - Very high strength stainless steel  
 A - Carbon steel  
 AC - Stainless steel

**Shell -** Very high strength stainless steel  
 A - Carbon steel  
 AC - Stainless steel

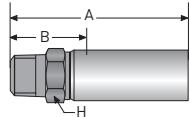

Part Number	Nominal I.D.		Thread Size		A Overall Length		B Cutoff Allowance		H Hex		Maximum Working Pressure		
	DN	Size	inch	mm	inch	mm	inch	mm	inch	mm	psi	bar	
<b>#</b>													
6018X-2-2A	4	-025	5/32	4.0	1/8" - 27	1.86	47	0.76	19	0.630	16	15,000	1,030
6018X-2-2AC	4	-025	5/32	4.0	1/8" - 27	2.18	55	1.80	46	0.500	13	15,000	1,030
6018X-4-2AC	4	-025	5/32	4.0	1/4" - 18	2.44	62	1.35	34	0.620	16	15,000	1,030
6018X-6-4	6	-04	1/4	6.4	3/8" - 18	2.80	71	1.50	38	0.750	19	15,000	1,030
6018X-8-8C	12	-08	1/2	12.7	1/2" - 14	3.46	88	1.67	42	1.000	25	15,000	1,030



**WARNING**

This product can expose you to chemicals including Lead, which is known to the State of California to cause cancer and birth defects or other reproductive harm. For more information go to [www.P65Warnings.ca.gov](http://www.P65Warnings.ca.gov).

# 8X Series Fittings

## 1018X- NPT Male

Material: Nipple - Carbon steel, zinc-plated  
 C - Stainless steel  
 Shell - Carbon steel, zinc-plated  
 C - Stainless steel

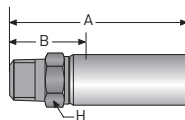

Part Number	Nominal I.D.				Thread Size	A Overall Length		B Cutoff Allowance		H Hex		Maximum Working Pressure	
	DN	Size	inch	mm		inch	mm	inch	mm	inch	mm	psi	bar
#													
1018X-4-04	6	-04	1/4	6.4	1/4" - 18	2.54	65	1.30	33	0.560	14	15,000	1,030
1018X-4-04C	6	-04	1/4	6.4	1/4" - 18	2.54	65	1.30	33	0.560	14	15,000	1,030
1018X-6-04	6	-04	1/4	6.4	3/8" - 18	2.64	67	1.38	35	0.750	19	15,000	1,030
1018X-6-04C	6	-04	1/4	6.4	3/8" - 18	2.64	67	1.38	35	0.750	19	15,000	1,030

## 1028X- NPT Female

Material: Nipple - Carbon steel, zinc-plated  
 C - Stainless steel  
 Shell - Carbon steel, zinc-plated  
 C - Stainless steel

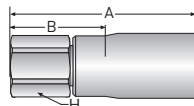

Part Number	Nominal I.D.				Thread Size	A Overall Length		B Cutoff Allowance		H Hex		Maximum Working Pressure	
	DN	Size	inch	mm		inch	mm	inch	mm	inch	mm	psi	bar
#													
1028X-4-04	6	-04	1/4	6.4	1/4" - 18	2.72	69	1.18	30	0.750	19	15,000	1,030
1028X-4-04C	6	-04	1/4	6.4	1/4" - 18	2.72	69	1.18	30	0.750	19	15,000	1,030



### WARNING

This product can expose you to chemicals including Lead, which is known to the State of California to cause cancer and birth defects or other reproductive harm. For more information go to [www.P65Warnings.ca.gov](http://www.P65Warnings.ca.gov).

# 8X Series Fittings

## 6068X- JIC 37° Female Flare

Material: Nipple - Stainless steel  
 Shell - Stainless steel  
 Nut - Stainless steel

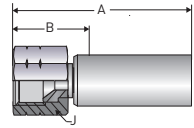

Part Number	Nominal I.D.				Thread Size	A Overall Length		B Cutoff Allowance		J Hex		Maximum Working Pressure	
#													
	DN	Size	inch	mm		inch	mm	inch	mm	inch	mm	psi	bar
6068X-4-2AC	4	-025	5/32	4.0	7/16" - 20	2.17	55	1.05	27	0.560	14	10,000	690
6068X-4-04C	12	-08	1/2	12.7	3/4" - 1	3.10	79	1.30	33	0.870	22	10,000	690

## 1068X- JIC 37° Female Flare

Material: Nipple - Carbon steel, zinc-plated  
 C - Stainless steel  
 SUBSEA - High strength stainless steel  
 Shell / Nut - Carbon steel, zinc-plated  
 C / SUBSEA - Stainless steel

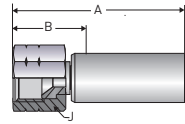

Part Number	Nominal I.D.				Thread Size	A Overall Length		B Cutoff Allowance		H Hex		Maximum Working Pressure	
#													
	DN	Size	inch	mm		inch	mm	inch	mm	inch	mm	psi	bar
1068X-4-025C-SUBSEA	4	-025	5/32	4.0	7/16" - 20	2.37	60	1.15	29	0.625	16	10,000	690
1068X-4-04	6	-04	1/4	6.4	7/16" - 18	2.24	57	1.02	26	0.750	19	10,000	690
1068X-4-04C	6	-04	1/4	6.4	7/16" - 20	2.24	57	1.02	26	0.750	19	10,000	690
1068X-6-04	6	-04	1/4	6.4	9/16" - 18	2.17	55	0.94	24	0.750	19	10,000	690
1068X-6-04C	6	-04	1/4	6.4	9/16" - 18	2.17	55	0.94	24	0.750	19	10,000	690
1068X-16-16C-SUBSEA	25	-16	1	25.4	1-5/16"-12	3.80	97	1.70	44	1.610	41	5,000	345



**WARNING**

This product can expose you to chemicals including Lead, which is known to the State of California to cause cancer and birth defects or other reproductive harm. For more information go to [www.P65Warnings.ca.gov](http://www.P65Warnings.ca.gov).

# 8X Series Fittings

## 1378X- JIC 45°

Material: Nipple - High strength stainless steel  
 Shell - Stainless steel  
 Nut - Stainless steel

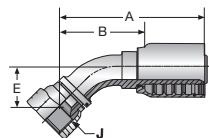

Part Number	Nominal I.D.				Thread Size	A Overall Length		B Cutoff Allowance		E		J Hex		Maximum Working Pressure	
#															
	DN	Size	inch	mm		inch	mm	inch	mm	inch	mm	inch	mm	psi	bar
1378X-16-16C-SUBSEA	25	-16	1	25.4	1-5/16"-12	5.00	127	2.91	74.0	1.23	31.3	1.61	41	5,000	345

## 1398X- JIC 90°

Material: Nipple - High strength stainless steel  
 Shell - Stainless steel  
 Nut - Stainless steel

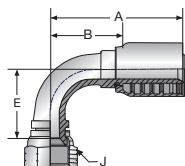

Part Number	Nominal I.D.				Thread Size	A Overall Length		B Cutoff Allowance		E		J Hex		Maximum Working Pressure	
#															
	DN	Size	inch	mm		inch	mm	inch	mm	inch	mm	inch	mm	psi	bar
1398X-16-16C-SUBSEA	25	-16	1	25.4	1-5/16"-12	4.65	118	2.56	65.0	2.62	65.0	1.61	41	5,000	345

## 19G8X- Straight Dual Seal

Material: Nipple - High strength stainless steel  
 Shell - Stainless steel  
 Nut - Stainless steel

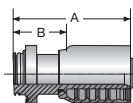

Part Number	Nominal I.D.				Thread Size	A Overall Length		B Cutoff Allowance		Maximum Working Pressure	
#											
	DN	Size	inch	mm		inch	mm	inch	mm	psi	bar
19G8X-16-16C-SUBSEA	25	-16	1	25.4	—	3.812	97	1.726	43.8	5,000	690
19G8X-24-16C-SUBSEA	25	-16	1	25.4	—	4.062	103	1.976	50.2	5,000	690



### WARNING

This product can expose you to chemicals including Lead, which is known to the State of California to cause cancer and birth defects or other reproductive harm. For more information go to [www.P65Warnings.ca.gov](http://www.P65Warnings.ca.gov).

## 8X Series Fittings

### 19M8X- Dual Seal 45°

Material: Nipple - High strength stainless steel  
Shell - Stainless steel  
Nut - Stainless steel

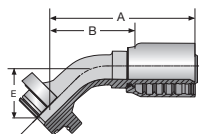

Part Number	Nominal I.D.				Flange Diameter		A Overall Length		B Cutoff Allowance		E		Maximum Working Pressure	
	#													
	DN	Size	inch	mm	inch	mm	inch	mm	inch	mm	inch	mm	psi	bar
19M8X-16-16C-SUBSEA	25	-16	1	25.4	1.88	47.6	5.30	134.5	3.21	81.5	1.525	38.7	5,000	345
19M8X-24-16C-SUBSEA	25	-16	1	25.4	2.5	63.5	5.47	139	3.39	86.0	1.702	43.2	5,000	345

### 19W8X- Dual Seal 90°

Material: Nipple - High strength stainless steel  
Shell - Stainless steel  
Nut - Stainless steel

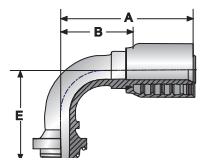

Part Number	Nominal I.D.				Flange Diameter		A Overall Length		B Cutoff Allowance		E		Maximum Working Pressure	
	#													
	DN	Size	inch	mm	inch	mm	inch	mm	inch	mm	inch	mm	psi	bar
19W8X-16-16C-SUBSEA	25	-16	1	25.4	1.88	47.6	4.65	118	2.56	65.0	1.525	38.7	5,000	345
19W8X-24-16C-SUBSEA	25	-16	1	25.4	2.5	63.5	4.65	118	2.56	65.0	3.382	85.9	5,000	345

### 1928X- BSP Swivel - Female

Material: Nipple - Carbon steel, zinc-plated  
Shell - Carbon steel, zinc-plated  
Nut - Carbon steel, zinc-plated  
Suffix "C" - All components stainless steel

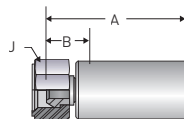

Part Number	Nominal I.D.				Thread Size	A Overall Length		B Cutoff Allowance		J Hex		Maximum Working Pressure*	
	#												
	DN	Size	inch	mm		inch	mm	inch	mm	inch	mm	psi	bar
1928X-4-04	6	-04	1/4	6.4	G 1/4" - 19	2.20	56	0.98	25	0.750	19	—	—
1928X-4-04C	6	-04	1/4	6.4	G 1/4" - 19	2.20	56	0.98	25	0.750	19	—	—

\* Fitting is rated to the full working pressure of the hose



#### WARNING

This product can expose you to chemicals including Lead, which is known to the State of California to cause cancer and birth defects or other reproductive harm. For more information go to [www.P65Warnings.ca.gov](http://www.P65Warnings.ca.gov).



# 8X Series Fittings

## 15Y8X- Medium Pressure Swivel - Female

Material: Nipple - Carbon steel  
 Shell - Carbon steel, zinc-plated  
 Nut - Stainless steel  
 Suffix "C" - All components stainless steel

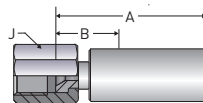

Part Number	Nominal I.D.				Thread Size	A Overall Length		B Cutoff Allowance		J Hex		Maximum Working Pressure	
	DN	Size	inch	mm		inch	mm	inch	mm	inch	mm	psi	bar
#													
15Y8X-6-04C	6	-04	1/4	6.4	9/16" - 18	2.24	57	.937	24	0.750	19	20,000	1,380

## 6AY8X- Type "M" Swivel - Female

Material: Nipple - High strength steel  
 AC - Stainless steel  
 C - High strength stainless steel  
 Shell - Carbon steel, zinc-plated  
 AC - Stainless steel  
 C - Stainless steel  
 Nut - High strength steel  
 AC - Stainless steel  
 C - Stainless steel

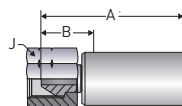

Part Number	Nominal I.D.				Thread Size	A Overall Length		B Cutoff Allowance		J Hex		Maximum Working Pressure*	
	DN	Size	inch	mm		inch	mm	inch	mm	inch	mm	psi	bar
#													
6AY8X-6-2AC	3	-02	1/8	3.2	9/16" - 18	2.32	59	1.24	31	0.680	17	—	—
6AY8X-6-4	6	-04	1/4	6.4	9/16" - 18	2.54	65	1.30	33	0.750	19	—	—
6AY8X-8-5C	8	-05	5/16	7.9	3/4" - 16	2.95	75	1.25	32	1.000	25	—	—
6AY8X-11-8C	12	-08	1/2	12.7	1" - 12	3.27	83	1.49	38	1.250	32	—	—

\* Fitting is rated to the full working pressure of the hose



### WARNING

This product can expose you to chemicals including Lead, which is known to the State of California to cause cancer and birth defects or other reproductive harm. For more information go to [www.P65Warnings.ca.gov](http://www.P65Warnings.ca.gov).

# 8X Series Fittings

## 1AY8X- Type "M" Swivel - Female

Material: Nipple - Carbon steel, zinc-plated  
 C - Stainless steel  
 Shell - Carbon steel, zinc-plated stainless steel

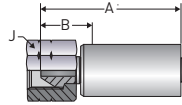

Part Number	Nominal I.D.				Thread Size	A Overall Length		B Cutoff Allowance		J Hex		Maximum Working Pressure*	
	DN	Size	inch	mm		inch	mm	inch	mm	inch	mm	psi	bar
#													
1AY8X-6-04	6	-04	1/4	6.4	9/16"-18	2.68	68	1.38	35	0.670	17	-	-
1AY8X-6-04C	6	-04	1/4	6.4	9/16"-18	2.68	68	1.38	35	0.670	17	-	-

\* Fitting is rated to the full working pressure of the hose

## 1C38X- Metric Swivel - Female

Material: Nipple - High strength steel  
 Shell - Carbon steel, zinc-plated  
 Nut - Carbon steel

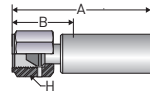

Part Number	Nominal I.D.				Thread Size	A Overall Length		B Cutoff Allowance		H Hex		Maximum Working Pressure*	
	DN	Size	inch	mm		inch	mm	inch	mm	inch	mm	psi	bar
#													
1C38X-8-04	6	-04	1/4	6.4	M 14 x 1.5	2.45	62	1.20	30	0.750	19	-	-

\* Fitting is rated to the full working pressure of the hose

## 1C98X- Metric Swivel - Female

Material: Nipple - High strength steel  
 Shell - Carbon steel, zinc-plated  
 Nut - Carbon steel

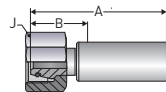

Part Number	Nominal I.D.				Thread Size	A Overall Length		B Cutoff Allowance		J Hex		Maximum Working Pressure*	
	DN	Size	inch	mm		inch	mm	inch	mm	inch	mm	psi	bar
#													
1C98X-8-04C	6	-04	1/4	6.4	M 16 x 1.5	2.32	59	1.06	27	0.750	19	-	-
1C98X-10-04C	6	-04	1/4	6.4	M 18 x 1.5	2.20	56	1.30	33	0.866	22	-	-

\* Fitting is rated to the full working pressure of the hose



**WARNING**

This product can expose you to chemicals including Lead, which is known to the State of California to cause cancer and birth defects or other reproductive harm. For more information go to [www.P65Warnings.ca.gov](http://www.P65Warnings.ca.gov).

# 8X Series Fittings

## 1D98X- BSP Rigid - Male

Material: Nipple - High strength steel  
Shell - Carbon steel, zinc-plated

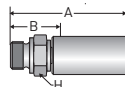

Part Number	Nominal I.D.				Thread Size	A Overall Length		B Cutoff Allowance		H Hex		Maximum Working Pressure*	
	DN	Size	inch	mm		inch	mm	inch	mm	inch	mm	psi	bar
#													
1D98X-4-4	6	-04	1/4	6.4	1/4" BSPP	2.65	67	1.39	35	0.750	19	—	—

\* Fitting is rated to the full working pressure of the hose

## 1MB8X- Stecko - Male

Material: Nipple - High strength steel  
Shell - Carbon steel, zinc-plated

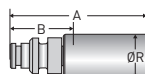

Part Number	Nominal I.D.				Thread Size	A Overall Length		B Cutoff Allowance		R Diameter		Maximum Working Pressure	
	DN	Size	inch	mm		inch	mm	inch	mm	inch	mm	psi	bar
#													
1MB8X-6-4	6	-04	1/4	6.4	—	2.85	72	1.58	40	0.860	22	10,000	690

## 1Y28X- Medium Pressure - Male

Material: Nipple - Stainless steel  
Shell - Stainless steel

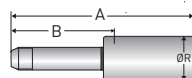



Part Number	Nominal I.D.				Thread Size	A Overall Length		B Cutoff Allowance		R Diameter		Maximum Working Pressure	
	DN	Size	inch	mm		inch	mm	inch	mm	inch	mm	psi	bar
#													
1Y28X-6-04C	6	-04	1/4	6.4	3/8"-24 LH	4.29	109	2.20	56	0.860	22	20,000	1,380



### WARNING

This product can expose you to chemicals including Lead, which is known to the State of California to cause cancer and birth defects or other reproductive harm. For more information go to [www.P65Warnings.ca.gov](http://www.P65Warnings.ca.gov).

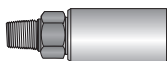

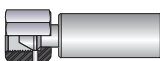

# 9X Series Fittings

<b>9X Series Crimp Fittings</b>	<b>01</b> NPT - Male	<b>06</b> JIC 37° Flare - Female	<b>AY</b> Type "M" Swivel - Female
	 B-24	 B-25	 B-25

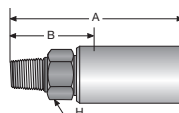
## 6019X- NPT Male

**Material:** Nipple - High strength steel  
 C - Stainless steel  
 Shell - Carbon steel  
 C - Stainless steel



Part Number	Nominal I.D.				Thread Size	A Overall Length		B Cutoff Allowance		H Hex		Maximum Working Pressure	
	DN	Size	inch	mm		inch	mm	inch	mm	inch	mm	psi	bar
<b>#</b>													
6019X-6-6	10	-06	3/8	9.5	3/8" - 18	2.95	75	1.35	34	0.750	19	15,000	1,030
6019X-6-6C	10	-06	3/8	9.5	3/8" - 18	2.95	75	1.35	34	0.750	19	15,000	1,030
6019X-8-6	10	-06	3/8	9.5	1/2" - 14	3.16	80	1.56	40	0.870	22	15,000	1,030
6019X-8-6C	10	-06	3/8	9.5	1/2" - 14	3.16	80	1.56	40	0.870	22	15,000	1,030
6019X-8-8	12	-08	1/2	12.7	1/2" - 14	3.35	85	1.43	36	0.870	22	15,000	1,030
6019X-8-8C	12	-08	1/2	12.7	1/2" - 14	3.37	86	1.68	43	1.000	25	15,000	1,030
6019X-16-16C	25	-16	1	25.4	1" - 11 1/2	4.38	111	2.25	57	1.380	35	10,000	690



**WARNING**

This product can expose you to chemicals including Lead, which is known to the State of California to cause cancer and birth defects or other reproductive harm. For more information go to [www.P65Warnings.ca.gov](http://www.P65Warnings.ca.gov).

# 9X Series Fittings

## 6069X- JIC 37° Female Flare

Material: Nipple - High strength stainless steel  
 Shell - Stainless steel  
 Nut - Stainless steel

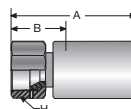

Part Number	Nominal I.D.				Thread Size	A Overall Length		B Cutoff Allowance		H Hex		Maximum Working Pressure	
#	⊙				⌘					⬡		↻	
	DN	Size	inch	mm		inch	mm	inch	mm	inch	mm	psi	bar
6069X-4-4C	6	-04	1/4	6.4	7/16" - 20	2.24	57	0.98	25	0.630	16	10,000	690
6069X-6-4C	6	-04	1/4	6.4	9/16" - 18	2.36	60	1.10	28	0.680	17	10,000	690
6069X-8-6C	10	-06	3/8	9.5	3/4" - 16	2.79	71	1.19	30	1.000	25	10,000	690
6069X-8-8C	12	-08	1/2	12.7	3/4" - 16	3.00	76	1.30	33	0.870	22	10,000	690
6069X-16-16C	25	-16	1	25.4	1-5/16" - 12	3.79	96	1.65	42	1.500	38	10,000	690

## 6AY9X- Type "M" Swivel - Female

Material: Nipple - High strength stainless steel  
 Shell - Stainless steel  
 Nut - Stainless steel

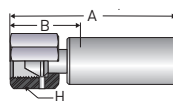

Part Number	Nominal I.D.				Thread Size	A Overall Length		B Cutoff Allowance		H Hex		Maximum Working Pressure*	
#	⊙				⌘					⬡		↻	
	DN	Size	inch	mm		inch	mm	inch	mm	inch	mm	psi	bar
6AY9X-6-4C	6	-04	1/4	6.4	9/16" - 18	2.36	60	1.10	28	0.680	17	—	—
6AY9X-8-6C	10	-06	3/8	9.5	3/4" - 16	2.79	71	1.19	30	1.000	25	—	—
6AY9X-11-8C	12	-08	1/2	12.7	1" - 12	3.20	81	1.50	38	1.250	32	—	—
6AY9X-16-16C	25	-16	1	25.4	1-5/16" - 12	3.79	96	1.65	42	1.500	38	—	—

\* Fitting is rated to the full working pressure of the hose



### WARNING

This product can expose you to chemicals including Lead, which is known to the State of California to cause cancer and birth defects or other reproductive harm. For more information go to [www.P65Warnings.ca.gov](http://www.P65Warnings.ca.gov).

# AX Series Fittings

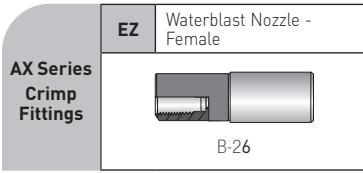

## 6EZAX- Waterblast Nozzle - Female

Material: Nipple - Carbon steel  
Shell - Carbon steel

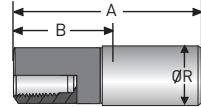

Part Number	Nominal I.D.				Thread Size	A Overall Length		B Cutoff Allowance		R Diameter		Maximum Working Pressure*	
#	⊙				⌘					∅		↗	
	DN	Size	inch	mm		inch	mm	inch	mm	inch	mm	psi	bar
6EZAX-5-2A	3	-02	1/8	3.2	1/4" - 28 LH	3.5	88	1.97	50	0.615	16	—	—

\* Fitting is rated to the full working pressure of the hose



### WARNING

This product can expose you to chemicals including Lead, which is known to the State of California to cause cancer and birth defects or other reproductive harm. For more information go to [www.P65Warnings.ca.gov](http://www.P65Warnings.ca.gov).



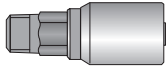
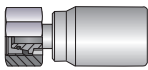
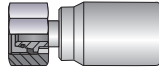

# BL Series Fittings

BL Series Crimp Fittings	<b>01</b>	NPT - Male	<b>AY</b>	Type "M" Swivel - Female	<b>C9</b>	Metric Swivel - Female
		B-27		B-28		B-28

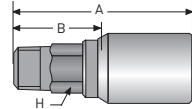
## 101BL- NPT Male

Material: Nipple - Carbon steel, zinc-plated  
 C - Stainless steel  
 Shell - Carbon steel, zinc-plated  
 C - Stainless steel



Part Number	Nominal I.D.				Thread Size	A Overall Length		B Cutoff Allowance		H Hex		Maximum Working Pressure	
#													
	DN	Size	inch	mm		inch	mm	inch	mm	inch	mm	psi	bar
101BL-6-06	10	-06	3/8	9.5	3/8" - 18	3.15	80	1.38	35	0.870	22	15,000	1,030
101BL-8-08	12	-08	1/2	12.7	1/2" - 14	3.54	90	1.77	45	0.870	22	15,000	1,030
101BL-8-08C	12	-08	1/2	12.7	1/2" - 14	3.54	90	1.77	45	0.870	22	15,000	1,030
101BL-12-12	20	-12	3/4	19.0	3/4" - 14	3.86	98	1.77	45	1.180	30	10,000	690



### WARNING

This product can expose you to chemicals including Lead, which is known to the State of California to cause cancer and birth defects or other reproductive harm. For more information go to [www.P65Warnings.ca.gov](http://www.P65Warnings.ca.gov).

# BL Series Fittings

## 1AYBL- Type "M" Swivel - Female

Material: Nipple - Carbon steel, zinc-plated  
C - Stainless steel  
Shell - Carbon steel, zinc-plated  
C - Stainless steel  
Nut - Carbon steel, zinc-plated  
C - Stainless steel

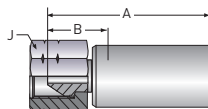

Part Number	Nominal I.D.				Thread Size	A Overall Length		B Cutoff Allowance		J Hex		Maximum Working Pressure*	
	DN	Size	inch	mm		inch	mm	inch	mm	inch	mm	psi	bar
#													
1AYBL-11-06	10	-06	3/8	9.5	1" - 12	3.03	77	1.24	31	1.250	32	—	—
1AYBL-11-08	12	-08	1/2	12.7	1" - 12	3.03	77	1.24	31	1.250	32	—	—
1AYBL-11-08C	12	-08	1/2	12.7	1" - 12	3.03	77	1.24	31	1.250	32	—	—

\* Fitting is rated to the full working pressure of the hose

## 1C9BL- Metric Swivel - Female

Material: Nipple - Carbon steel, zinc-plated  
Shell - Carbon steel, zinc-plated

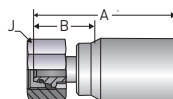

Part Number	Nominal I.D.				Thread Size	A Overall Length		B Cutoff Allowance		J Hex		Maximum Working Pressure*	
	DN	Size	inch	mm		inch	mm	inch	mm	inch	mm	psi	bar
#													
1C9BL-14-06	10	-06	3/8	9.5	M 22 x 1.5	3.15	80	1.43	36	1.180	30	—	—
1C9BL-16-06	10	-06	3/8	9.5	M 24 x 1.5	3.31	84	1.43	36	1.180	30	—	—
1C9BL-14-08	12	-08	1/2	12.7	M 22 x 1.5	3.15	80	1.43	36	1.060	27	—	—
1C9BL-16-08	12	-08	1/2	12.7	M 24 x 1.5	3.15	80	1.43	36	1.180	30	—	—
1C9BL-25-12	20	-12	3/4	19.0	M 36 x 2.0	3.82	97	1.75	44	1.810	46	—	—

\*Fitting is rated to the full working pressure of the hose



### WARNING

This product can expose you to chemicals including Lead, which is known to the State of California to cause cancer and birth defects or other reproductive harm. For more information go to [www.P65Warnings.ca.gov](http://www.P65Warnings.ca.gov).

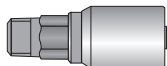
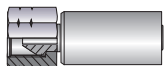
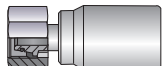

# BS Series Fittings

BS Series Crimp Fittings	<b>01</b>	NPT - Male	<b>AY</b>	Type "M" Swivel - Female	<b>C9</b>	Metric Swivel - Female
		B-29		B-29		B-30

## 101BS- NPT Male





Material: Nipple - Carbon steel, zinc-plated

C - Stainless steel

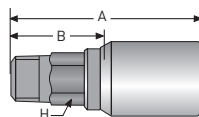
Shell - Carbon steel, zinc-plated

C - Stainless steel



Part Number	Nominal I.D.				Thread Size	A Overall Length		B Cutoff Allowance		H Hex		Maximum Working Pressure	
#													
	DN	Size	inch	mm		inch	mm	inch	mm	inch	mm	psi	bar
101BS-8-08	12	-08	1/2	12.7	1/2" - 14	3.66	93	1.56	40	0.870	22	15,000	1,030
101BS-8-08C	12	-08	1/2	12.7	1/2" - 14	3.66	93	1.56	40	0.870	22	15,000	1,030

## 1AYBS- Type "M" Swivel - Female





Material: Nipple - Carbon steel, zinc-plated

C - Stainless steel

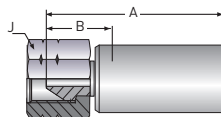
Shell - Carbon steel, zinc-plated

C - Stainless steel



Part Number	Nominal I.D.				Thread Size	A Overall Length		B Cutoff Allowance		J Hex		Maximum Working Pressure*	
#													
	DN	Size	inch	mm		inch	mm	inch	mm	inch	mm	psi	bar
1AYBS-11-08	12	-08	1/2	12.7	1" - 12	3.03	77	1.24	31	1.250	32	—	—
1AYBS-11-08C	12	-08	1/2	12.7	1" - 12	3.03	77	1.24	31	1.250	32	—	—

\* Fitting is rated to the full working pressure of the hose



### WARNING

This product can expose you to chemicals including Lead, which is known to the State of California to cause cancer and birth defects or other reproductive harm. For more information go to [www.P65Warnings.ca.gov](http://www.P65Warnings.ca.gov).

# BS Series Fittings

## 1C9BS- Metric Swivel - Female

Material: Nipple - Carbon steel, zinc-plated  
 Shell - Carbon steel, zinc-plated  
 Nut - Carbon steel, zinc-plated

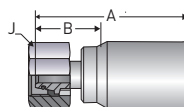

Part Number	Nominal I.D.				Thread Size	A Overall Length		B Cutoff Allowance		J Hex		Maximum Working Pressure*	
#													
	DN	Size	inch	mm		inch	mm	inch	mm	inch	mm	psi	bar
1C9BS-16-08	12	-08	1/2	12.7	M 24 x 1.5	3.50	89	1.43	36	1.180	30	—	—

\* Fitting is rated to the full working pressure of the hose



### WARNING

This product can expose you to chemicals including Lead, which is known to the State of California to cause cancer and birth defects or other reproductive harm. For more information go to [www.P65Warnings.ca.gov](http://www.P65Warnings.ca.gov).

# CR Series Fittings

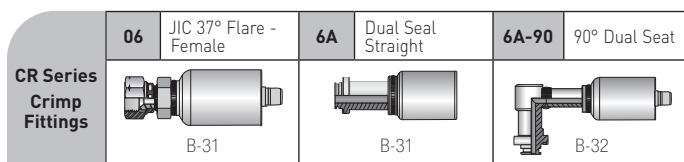



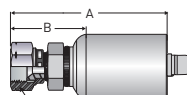

\* 6A code in all CR Series fittings refers to Dual Seal Connection, straights and 90's

## 606CR- JIC 37° Female Flare

Material: Nipple - Stainless steel  
Shell - Stainless steel  
Nut - Stainless steel





Part Number	Nominal I.D.				Thread Size	A Overall Length		B Cutoff Allowance		H Hex		Maximum Working Pressure	
	DN	Size	inch	mm		inch	mm	inch	mm	inch	mm	psi	bar
#													
606CR-8-8C	12	-08	1/2	12.7	3/4" - 16	3.88	98	2.13	54	1.000	25	10,000	690
606CR-16-16C	25	-16	1	25.4	1 5/16" - 12	5.00	127	2.75	70	1.625	41	10,000	690

## 66ACR- Straight Dual Seal

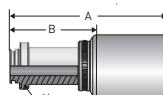
Material: Nipple - Stainless steel  
Shell - Stainless steel



Part Number	Nominal I.D.				Flange Size	A Overall Length		B Cutoff Allowance		H Hex		Maximum Working Pressure	
	DN	Size	inch	mm		inch	mm	inch	mm	inch	mm	psi	bar
#													
66ACR-8-8C-SUBSEA	12	-08	1/2	12.7	1/2	4.80	122	2.65	67	1.250	32	5,000	340
66ACR-16-8C-SUBSEA	12	-08	1/2	12.7	1	5.39	137	4.01	102	1.875	48	5,000	340
66ACR-16-16C-SUBSEA	25	-16	1	25.4	1	6.30	160	3.43	87	1.875	48	5,000	340
66ACR-24-16C-SUBSEA	25	-16	1	25.4	1-1/2	5.30	135	2.43	62	2.500	64	5,000	340



### WARNING

This product can expose you to chemicals including Lead, which is known to the State of California to cause cancer and birth defects or other reproductive harm. For more information go to [www.P65Warnings.ca.gov](http://www.P65Warnings.ca.gov).

# CR Series Fittings

## 66ACR-x-90- 90° Dual Seal

Material: Nipple - Stainless steel  
Shell - Stainless steel

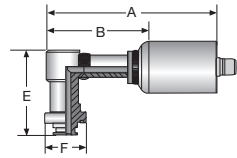

Part Number	Nominal I.D.				Flange Size		A Overall Length		B Cutoff Allowance		F		E		Maximum Working Pressure	
	DN	Size	inch	mm	inch	mm	inch	mm	inch	mm	inch	mm	inch	mm	psi	bar
#																
66ACR-8-8C-SUBSEA-90	12	-08	1/2	12.7	1/2	5.01	127	2.95	75	1.250	32	2.50	64	5,000	340	
66ACR-16-8C-SUBSEA-90	12	-08	1/2	12.7	1	5.94	151	3.79	96	1.875	48	3.35	85	5,000	340	
66ACR-16-16C-SUBSEA-90	25	-16	1	25.4	1	6.84	174	3.96	101	1.875	48	3.35	85	5,000	340	
66ACR-24-16C-SUBSEA-90	25	-16	1	25.4	1-1/2	6.90	175	4.03	102	2.500	64	3.82	97	5,000	340	



**WARNING**

This product can expose you to chemicals including Lead, which is known to the State of California to cause cancer and birth defects or other reproductive harm. For more information go to [www.P65Warnings.ca.gov](http://www.P65Warnings.ca.gov).



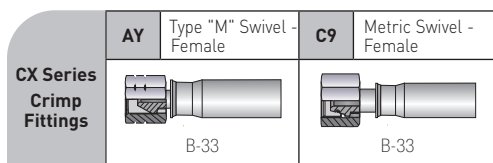

# CX Series Fittings

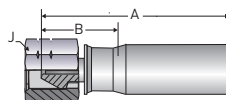

## 1AYCX- Type "M" Swivel - Female

Material: Nipple - High Strength Stainless steel  
 Shell - Carbon steel, zinc plated  
 Nut - Carbon steel, zinc plated







Part Number	Nominal I.D.				Thread Size	A Overall Length		B Cutoff Allowance		J Hex		Maximum Working Pressure*	
#													
	DN	Size	inch	mm		inch	mm	inch	mm	inch	mm	psi	bar
1AYCX-16-16W	25	-16	1	25.4	1-5/16" - 12	5.75	146	2.84	72	1.61	41	—	—

\* Fitting is rated to the full working pressure of the hose

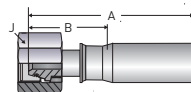
## 1C9CX- Metric Swivel - Female

Material: Nipple - High Strength Stainless steel  
 Shell - High Strength Carbon steel, zinc plated  
 Nut - High Strength Carbon steel, zinc plated



Part Number	Nominal I.D.				Thread Size	A Overall Length		B Cutoff Allowance		J Hex		Maximum Working Pressure*	
#													
	DN	Size	inch	mm		inch	mm	inch	mm	inch	mm	psi	bar
1C9CX-30-16W	25	-16	1	25.4	M42 x 2	4.76	121	2.17	55	2.17	55	—	—

\* Fitting is rated to the full working pressure of the hose







### WARNING

This product can expose you to chemicals including Lead, which is known to the State of California to cause cancer and birth defects or other reproductive harm. For more information go to [www.P65Warnings.ca.gov](http://www.P65Warnings.ca.gov).

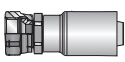
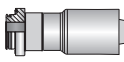
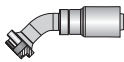
# E3/E4 Series\* Subsea Fittings

U.S. Patent No. 10,132,434

E3/E4 Series Subsea Fittings	<b>06</b> Straight JIC	<b>9G</b> Straight Dual Seal	<b>9M</b> 45° Dual Seal	<b>9W</b> 90° Dual Seal
	 B-36	 B-35	 B-34	 B-34
	<b>37</b> 45° JIC	<b>39</b> 90° JIC	*Patent Pending - Patented single piece bent tube design that reduces leak points and increases reliability.	
	 B-36	 B-35		

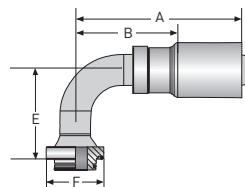

## 19WE3/19WE4 - 90° Dual Seal

Material: Nipple - Stainless steel  
Shell - Stainless steel

Part Number	Nominal I.D.		Flange Size		A Overall Length		B Cutoff Allowance		F		E		Maximum Working Pressure	
	DN	Size	inch	mm	inch	mm	inch	mm	inch	mm	inch	mm	psi	bar
#														
19WE3-8-8C	12	-08	1/2	12.7	1/2	4.11	104	2.44	62	1.25	32	2.11	54	5,000 340
19WE3-16-8C	12	-08	1/2	12.7	1	4.11	104	2.44	62	1.88	48	2.17	55	5,000 340
19WE4-16-16C	25	-16	1	25.4	1	5.45	138	3.13	80	1.88	48	3.27	83	5,000 340
19WE4-24-16C	25	-16	1	25.4	1-1/2	5.88	149	3.38	86	2.50	64	3.52	89	5,000 340

## 19ME3/19ME4 - 45° Dual Seal

Material: Nipple - Stainless steel  
Shell - Stainless steel

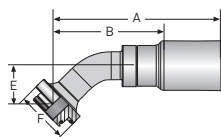

Part Number	Nominal I.D.		Flange Size		A Overall Length		B Cutoff Allowance		F		E		Maximum Working Pressure	
	DN	Size	inch	mm	inch	mm	inch	mm	inch	mm	inch	mm	psi	bar
#														
19ME3-8-8C	12	-08	1/2	12.7	1/2	4.49	114	2.68	68	1.25	32	0.87	22	5,000 340
19ME3-16-8C	12	-08	1/2	12.7	1	4.53	115	2.68	68	1.88	48	0.92	23	5,000 340
19ME4-16-16C	25	-16	1	25.4	1	6.24	158	3.88	99	1.88	48	1.42	36	5,000 340
19ME4-24-16C	25	-16	1	25.4	1-1/2	6.32	161	3.93	100	2.50	64	1.86	47	5,000 340



### WARNING

This product can expose you to chemicals including Lead, which is known to the State of California to cause cancer and birth defects or other reproductive harm. For more information go to [www.P65Warnings.ca.gov](http://www.P65Warnings.ca.gov).

# E3/E4 Series\* Subsea Fittings

## 19GE3/19GE4 - Straight Dual Seal

Material: Nipple - Stainless steel  
Shell - Stainless steel

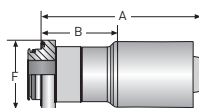

Part Number	Nominal I.D.				Flange Size	A Overall Length		B Cutoff Allowance		F		Maximum Working Pressure	
	DN	Size	inch	mm		inch	mm	inch	mm	inch	mm	psi	bar
#	⊙											⊙	
19GE3-8-8C	12	-08	1/2	12.7	1/2	3.26	83	1.56	40	1.25	32	5,000	340
19GE3-16-8C	12	-08	1/2	12.7	1	3.26	83	1.56	40	1.25	32	5,000	340
19GE4-16-16C	25	-16	1	25.4	1	4.35	110	2.00	51	1.88	48	5,000	340
19GE4-24-16C	25	-16	1	25.4	1-1/2	4.48	114	2.13	54	2.50	64	5,000	340

## 139E3/139E4 - 90° JIC

Material: Nipple - Stainless steel  
Shell - Stainless steel  
Nut - Stainless steel

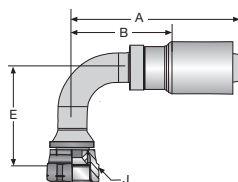

Part Number	Nominal I.D.				Thread Size	A Overall Length		B Cutoff Allowance		J Hex		E		Maximum Working Pressure	
	DN	Size	inch	mm		inch	mm	inch	mm	inch	mm	inch	mm	psi	bar
#	⊙				⌘					⬡				⊙	
139E3-4-4C	6	-04	1/4	6.4	7/16"x20	2.41	61	1.38	35	5/8	16	0.83	21	5,000	340
139E3-6-4C	6	-04	1/4	6.4	9/16"x18	2.41	61	1.38	35	3/4	19	0.91	23	5,000	340
139E3-8-8C-411	12	-08	1/2	12.7	3/4"x 6	4.11	104	2.44	62	15/16	24	2.11	54	5,000	340
139E4-16-16C-411	25	-16	1	25.4	1-5/16"x12	5.69	145	3.32	84	1-5/8	41	3.27	83	5,000	340

\*Patented single piece bent tube design that reduces leak points and increases reliability.



### WARNING

This product can expose you to chemicals including Lead, which is known to the State of California to cause cancer and birth defects or other reproductive harm. For more information go to [www.P65Warnings.ca.gov](http://www.P65Warnings.ca.gov).

# E3/E4 Series\* Subsea Fittings

U.S. Patent No. 10,132,434

## 137E3/137E4 - 45° JIC

Material: Nipple - Stainless steel  
Shell - Stainless steel  
Nut - Stainless steel

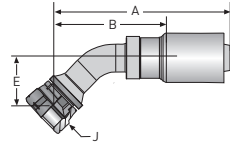

Part Number	Nominal I.D.		Thread Size		A Overall Length		B Cutoff Allowance		J Hex		E		Maximum Working Pressure		
#	⊙		⋈						⬡				⌚		
	DN	Size	inch	mm	inch	inch	mm	inch	mm	inch	mm	inch	mm	psi	bar
137E3-4-4C	6	-04	1/4	6.4	7/16" x 20	2.51	64	1.50	38	5/8	16	0.39	10	5,000	340
137E3-6-4C	6	-04	1/4	6.4	9/16" x 18	2.70	69	1.68	43	3/4	19	0.43	11	5,000	340
137E3-8-8C-411	12	-08	1/2	12.7	3/4" x 16	4.75	121	3.06	78	15/16	24	1.14	29	5,000	340
137E4-16-16C-411	25	-16	1	25.4	1-5/16" x 12	6.50	165	4.13	105	1-5/8	41	1.69	43	5,000	340

## 106E3/106E4 - Straight JIC

Material: Nipple - Stainless steel  
Shell - Stainless steel  
Nut - Stainless steel

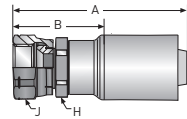

Part Number	Nominal I.D.		Thread Size		A Overall Length		B Cutoff Allowance		J Hex		H Hex		Maximum Working Pressure		
#	⊙		⋈						⬡		⬡		⌚		
	DN	Size	inch	mm	inch	inch	mm	inch	mm	inch	mm	inch	mm	psi	bar
106E3-4-4C	6	-04	1/4	6.4	7/16" x 20	2.46	62	1.44	37	5/8	16	5/8	16	5,000	340
106E3-6-4C	6	-04	1/4	6.4	9/16" x 18	2.55	65	1.50	38	3/4	19	5/8	16	5,000	340
106E3-8-8C	12	-08	1/2	12.7	3/4" x 16	3.55	90	1.88	48	1	25	15/16	24	5,000	340
106E4-16-16C	25	-16	1	25.4	1-5/16" x 12	4.76	121	2.38	60	1-5/8	41	1-1/2	41	5,000	340

\*Patented single piece bent tube design that reduces leak points and increases reliability.



**WARNING**

This product can expose you to chemicals including Lead, which is known to the State of California to cause cancer and birth defects or other reproductive harm. For more information go to [www.P65Warnings.ca.gov](http://www.P65Warnings.ca.gov).





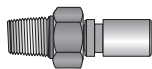
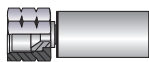
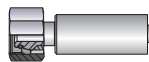

# EX Series Fittings

EX Series Crimp Fittings	01	NPT - Male	06	JIC 37° Flare - Female	C9	Metric Swivel - Female
						
	B-37		B-37		B-38	

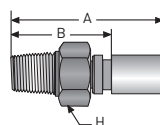
## 101EX/601EX- NPT Male

Material: Nipple - Carbon steel, zinc-plated  
 C - Stainless steel  
 Shell - Carbon steel, zinc-plated  
 C - Stainless steel





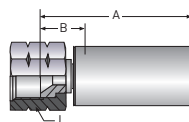

Part Number	Nominal I.D.				Thread Size	A Overall Length		B Cutoff Allowance		H Hex		Maximum Working Pressure	
#													
	DN	Size	inch	mm		inch	mm	inch	mm	inch	mm	psi	bar
101EX-4-012	2	-012	5/64	2	1/4" - 18	1.54	39	1.10	28	0.560	14	15,000	1,030
101EX-2-012	2	-012	5/64	2	1/8" - 27	1.37	35	0.93	24	0.44	11	15,000	1,030
601EX-2-2C	3	-02	1/8	3.2	1/8" - 27	1.33	34	.93	24	0.44	11	15,000	1,030

## 106EX- JIC 37° Female Flare

Material: Nipple - Carbon steel, zinc-plated  
 Shell - Carbon steel, zinc-plated  
 Nut - Carbon steel, zinc-plated



Part Number	Nominal I.D.				Thread Size	A Overall Length		B Cutoff Allowance		J Hex		Maximum Working Pressure	
#													
	DN	Size	inch	mm		inch	mm	inch	mm	inch	mm	psi	bar
106EX-4-012	2	-012	5/64	2	7/16" - 20	1.00	25	0.55	14	0.670	17	10,000	690
106EX-4-02	3	-02	1/8	3.2	7/16" - 20	.945	24	0.55	14	0.670	17	10,000	690



### WARNING

This product can expose you to chemicals including Lead, which is known to the State of California to cause cancer and birth defects or other reproductive harm. For more information go to [www.P65Warnings.ca.gov](http://www.P65Warnings.ca.gov).

# EX Series Fittings

## 1C9EX- Metric Swivel - Female

Material: Nipple - Carbon steel, zinc-plated  
 Shell - Carbon steel, zinc-plated  
 Nut - Carbon steel, zinc-plated

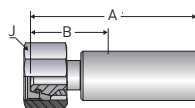

Part Number	Nominal I.D.				Thread Size	A Overall Length		B Cutoff Allowance		J Hex		Maximum Working Pressure	
	DN	Size	inch	mm		inch	mm	inch	mm	inch	mm	psi	bar
#													
1C9EX-8-012	2	-012	5/64	2	M 16 x 1.5	1.50	37	1.14	29	0.750	19	—	—
1C9EX-6-012	2	-012	5/64	2	M 14 x 1.5	1.30	32	0.83	21	0.670	17	—	—
1C9EX-8-02	3	-02	1/8	3.2	M 16 x 1.5	1.30	32	0.87	22	0.750	19	—	—

\* Fitting is rated to the full working pressure of the hose



### WARNING

This product can expose you to chemicals including Lead, which is known to the State of California to cause cancer and birth defects or other reproductive harm. For more information go to [www.P65Warnings.ca.gov](http://www.P65Warnings.ca.gov).

# HP Series Fittings

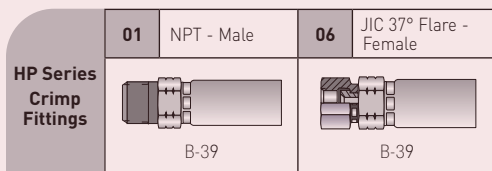

## 101HP- NPT Male

Material: Nipple - Carbon steel, zinc-plated  
 C - Stainless steel  
 Shell - Carbon steel, zinc-plated  
 C - Stainless steel

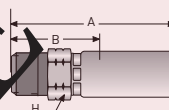

Part Number	Nominal I.D.		Thread Size		Overall Length		B Cutoff Allowance		H Hex		Maximum Working Pressure		
	DN	Size	inch	mm	inch	mm	inch	mm	inch	mm	psi	bar	
#	○		⋈						⬡		↻		
101HP-4-3	5	-03	3/16	4.8	1/4" - 18	2.12	56	1.38	35	0.690	17	15,000	1,030
101HP-6-3	5	-03	3/16	4.8	3/8" - 18	2.29	56	1.50	38	0.750	19	15,000	1,030
101HP-4-4	6	-04	1/4	6.4	1/4" - 18	2.28	58	1.38	35	0.690	17	15,000	1,030
101HP-6-4	6	-04	1/4	6.4	3/8" - 18	2.38	60	1.38	35	0.750	19	15,000	1,030
101HP-6-4C	6	-04	1/4	6.4	3/8" - 18	2.38	60	1.38	35	0.750	19	15,000	1,030
101HP-6-6	10	-06	3/8	9.5	1/8" - 18	2.70	69	1.50	38	0.750	19	15,000	1,030
101HP-8-6	10	-06	3/8	9.5	1/2" - 14	2.96	75	1.75	44	0.940	24	15,000	1,030

## 106HP- JIC 37° Female Flare

Material: Nipple - Carbon steel, zinc-plated  
 C - Stainless steel  
 Shell - Carbon steel, zinc-plated  
 C - Stainless steel

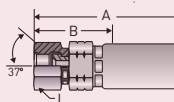

Part Number	Nominal I.D.		Thread Size		A Overall Length		B Cutoff Allowance		H Hex		Maximum Working Pressure		
	DN	Size	inch	mm	inch	mm	inch	mm	inch	mm	psi	bar	
#	○		⋈						⬡		↻		
106HP-4-3	5	-03	3/16	4.8	7/16" - 20	2.20	56	1.44	37	0.630	16	10,000	690
106HP-4-4	6	-04	1/4	6.4	7/16" - 20	2.49	63	1.56	40	0.630	16	10,000	690
106HP-6-4	6	-04	1/4	6.4	9/16" - 18	2.59	66	1.69	43	0.750	19	10,000	690
106HP-6-6	10	-06	3/8	9.5	9/16" - 18	2.91	74	1.63	41	0.750	19	10,000	690



### WARNING

This product can expose you to chemicals including Lead, which is known to the State of California to cause cancer and birth defects or other reproductive harm. For more information go to [www.P65Warnings.ca.gov](http://www.P65Warnings.ca.gov).



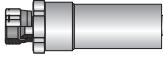
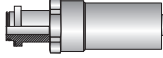

# HV Series Fittings

	<b>06</b> JIC 37° Flare - Female	<b>9G</b> Straight Dual Seal
<b>HV Series Crimp Fittings</b>	 B-40	 B-40

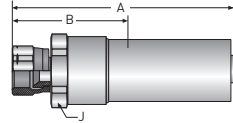
## 106HV - JIC 37° Female Flare

Material: 316 Stainless Steel





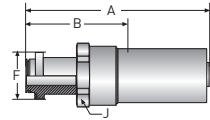

Part Number	Nominal I.D.				Thread Size	A Overall Length		B Cutoff Allowance		J Hex		Maximum Working Pressure	
	DN	Size	inch	mm		inch	mm	inch	mm	inch	mm	psi	bar
<b>#</b>													
106HV-8-8C	12	-08	1/2	12.7	3/4"-16 UNF	4.25	108	2.0	51	1-3/8	35	5,000	345
106HV-16-16C	25	-16	1	25.4	1-5/16"-16 UNF	6.55	166	3.5	89	2-3/8	60	5,000	345

## 19GHV - Straight Dual Seal

Material: 316 Stainless Steel



Part Number	Nominal I.D.				Flange Size	A Overall Length		B Cutoff Allowance		F Flange Diameter		J Hex		Maximum Working Pressure	
	DN	Size	inch	mm		inch	mm	inch	mm	inch	mm	inch	mm	psi	bar
<b>#</b>															
19GHV-8-8C	12	-08	1/2	12.7	1/2	5.37	136	3.15	80	1.25	32	1-3/8	35	5,000	345
19GHV-16-16C	25	-16	1	25.4	1	7.95	202	4.90	124	1.88	48	2-3/8	60	5,000	345



**WARNING**

This product can expose you to chemicals including Lead, which is known to the State of California to cause cancer and birth defects or other reproductive harm. For more information go to [www.P65Warnings.ca.gov](http://www.P65Warnings.ca.gov).

# HX Series Fittings

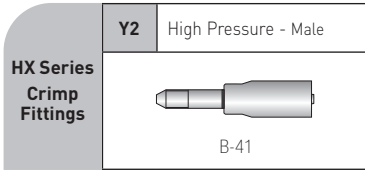



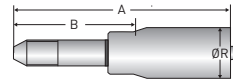

## 6Y2HX- High Pressure Male

only qualified with 2440D-05V32

Material: Nipple - Carbon steel, zinc-plated  
Shell - Carbon steel, zinc-plated



Part Number	Nominal I.D.				Thread Size	A Overall Length		B Cutoff Allowance		R Diameter		Maximum Working Pressure	
	DN	Size	inch	mm		inch	mm	inch	mm	inch	mm	psi	bar
<b>#</b>													
6Y2HX-9-5C-THD	8	-05	5/16	7.9	9/16"-18 LH	3.83	97	2.13	54	.95	24	20,000	1,380
6Y2HX-9-5C-LONG	8	-05	5/16	7.9	9/16"-18 LH	4.53	115	2.83	72	.95	24	20,000	1,380

Note: -THD: Extra long thread

-LONG: Extra long tube



### WARNING

This product can expose you to chemicals including Lead, which is known to the State of California to cause cancer and birth defects or other reproductive harm. For more information go to [www.P65Warnings.ca.gov](http://www.P65Warnings.ca.gov).



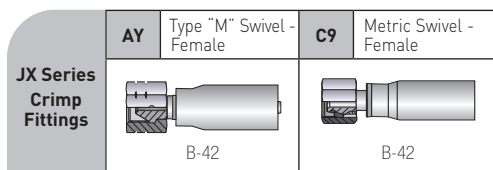

# JX Series Fittings

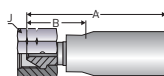

## 1AYJX - Type "M" Swivel - Female

Material: Nipple - Stainless steel  
Shell - Carbon steel, zinc-plated





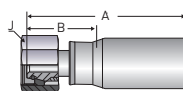

Part Number	Nominal I.D.				Thread Size	A Overall Length		B Cutoff Allowance		J Hex		Maximum Working Pressure	
	DN	Size	inch	mm		inch	mm	inch	mm	inch	mm	psi	bar
<b>#</b>													
1AYJX-16-12W	20	-12	3/4	19.0	1" 5/16-12UNF	3.54	90	1.22	31	1.61	41	-	-
1AYJX-11-08W	12	-08	1/2	12.7	1"-12UNF	3.39	86	1.14	29	1.26	32	-	-

## 1C9JX- Metric Swivel - Female

Material: Nipple - Stainless steel  
Shell - Carbon steel, zinc-plated



Part Number	Nominal I.D.				Thread Size	A Overall Length		B Cutoff Allowance		J Hex		Maximum Working Pressure	
	DN	Size	inch	mm		inch	mm	inch	mm	inch	mm	psi	bar
<b>#</b>													
1C9JX-25-12W	20	-12	3/4	19.0	M36x2	4.25	108	1.93	49	1.81	46	-	-
1C9JX-16-08W	12	-08	1/2	12.7	M24x1.5	3.78	96	1.54	39	1.26	32	-	-



**WARNING**

This product can expose you to chemicals including Lead, which is known to the State of California to cause cancer and birth defects or other reproductive harm. For more information go to [www.P65Warnings.ca.gov](http://www.P65Warnings.ca.gov).



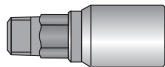
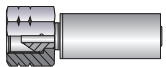
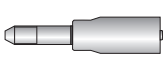

# KY Series Fittings

KY Series Crimp Fittings	01	NPT - Male	AY	Type "M" Swivel - Female	Y4	High Pressure - Male
						
	B-43		B-43		B-44	

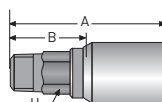
## 101KY- NPT Male

Material: Nipple - Carbon steel, zinc-plated  
Shell - Carbon steel, zinc-plated





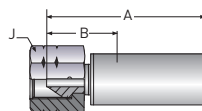

Part Number	Nominal I.D.				Thread Size	A Overall Length		B Cutoff Allowance		H Hex		Maximum Working Pressure	
	DN	Size	inch	mm		inch	mm	inch	mm	inch	mm	psi	bar
#													
101KY-4-04	6	-04	1/4	6.4	1/4" - 18	2.22	56	1.14	29	0.390	10	15,000	1,030
101KY-4-05	8	-05	5/16	7.9	1/4" - 18	2.70	69	1.42	36	0.511	13	15,000	1,030
101KY-6-04	6	-04	1/4	6.4	3/8" - 18	2.64	67	1.38	35	0.670	17	15,000	1,030

## 1AYKY- Type "M" Swivel - Female

Material: Nipple - Carbon steel, zinc-plated  
Shell - Carbon steel, zinc-plated  
Nut - Carbon steel, zinc-plated



Part Number	Nominal I.D.				Thread Size	A Overall Length		B Cutoff Allowance		J		Maximum Working Pressure	
	DN	Size	inch	mm		inch	mm	inch	mm	inch	mm	psi	bar
#													
1AYKY-6-04	6	-04	1/4	6.4	9/16"-18	2.28	58	0.98	25	0.748	19	-	-
1AYKY-8-05	8	-05	5/16	7.9	3/4" - 16	2.64	67	1.22	31	1.063	27	-	-



### WARNING

This product can expose you to chemicals including Lead, which is known to the State of California to cause cancer and birth defects or other reproductive harm. For more information go to [www.P65Warnings.ca.gov](http://www.P65Warnings.ca.gov).

# KY Series Fittings

## 1Y4KY- High Pressure - Male

Material: Nipple - Carbon steel, zinc-plated  
Shell - Carbon steel, zinc-plated

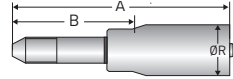

Part Number	Nominal I.D.				Thread Size	A Overall Length		B Cutoff Allowance		R Diameter		Maximum Working Pressure*	
#													
	DN	Size	inch	mm		inch	mm	inch	mm	inch	mm	psi	bar
1Y4KY-9-05	8	-05	5/16	7.9	9/16"-18	3.90	99	2.60	66	0.787	20	—	—

\* Fitting is rated to the full working pressure of the hose









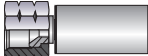

### WARNING

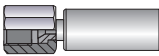
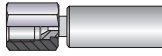
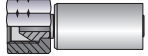
This product can expose you to chemicals including Lead, which is known to the State of California to cause cancer and birth defects or other reproductive harm. For more information go to [www.P65Warnings.ca.gov](http://www.P65Warnings.ca.gov).

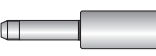
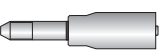

# LX Series Fittings

<b>LX Series Crimp Fittings</b>	<b>01</b> NPT - Male	<b>06</b> JIC 37° Flare - Female	<b>92</b> BSP Swivel - Female	<b>5Y</b> Med. Pressure Swivel - Female
	 B-45, B-46	 B-46, B-47	 B-48	 B-48
	<b>6Y</b> High Pressure Swivel - Female	<b>AY</b> Type "M" Swivel - Female	<b>C9</b> Metric Swivel - Female	<b>HE</b> Hammer Union - Male Cone
	 B-48	 B-49, B-50	 B-51	 B-52
	<b>HN</b> Hammer Union - Female Cone	<b>HY</b> Waterblast Nozzle - Female	<b>Y2</b> Med. Pressure - Male	<b>Y4</b> High Pressure - Male
	 B-52	 B-53	 B-53, B-54	 B-54, B-55
<b>YH</b> Waterblast Nozzle - Male	 B-55, B-56			

## 101LX- NPT Male

Material: Nipple - Carbon steel, zinc-plated C - Stainless steel  
 Shell - Carbon steel, zinc-plated C - Stainless steel  
 Nut - Carbon steel, zinc-plated C / SUBSEA - Stainless steel

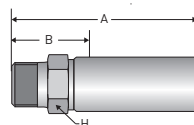

Part Number	Nominal I.D.				Thread Size	A Overall Length		B Cutoff Allowance		H Hex		Maximum Working Pressure	
#	⊙				⌀					⬡		⊕	
	DN	Size	inch	mm		inch	mm	inch	mm	inch	mm	psi	bar
101LX-4-04	6	-04	1/4	6.4	1/4"-18	3.15	80	1.42	36	0.560	14	15,000	1,030
101LX-6-04	6	-04	1/4	6.4	3/8"-18	3.15	80	1.42	36	0.750	19	15,000	1,030
101LX-8-08	12	-08	1/2	12.7	1/2"-14	3.58	91	1.46	37	0.87	22	15,000	1,030
101LX-8-08C	12	-08	1/2	12.7	1/2"-14	3.58	91	1.46	37	0.87	22	15,000	1,030



### WARNING

This product can expose you to chemicals including Lead, which is known to the State of California to cause cancer and birth defects or other reproductive harm. For more information go to [www.P65Warnings.ca.gov](http://www.P65Warnings.ca.gov).

# LX Series Fittings

## 601LX- NPT Male

Material: Nipple - High strength steel  
 C - Stainless steel  
 Shell - Carbon steel, zinc-plated  
 C - Stainless steel

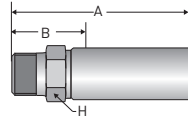

Part Number	Nominal I.D.				Thread Size	A Overall Length		B Cutoff Allowance		H Hex		Maximum Working Pressure	
	DN	Size	inch	mm		inch	mm	inch	mm	inch	mm	psi	bar
#													
601LX-4-3	5	-03	3/16	4.8	1/4" - 18	2.86	73	1.30	33	0.560	14	15,000	1,030
601LX-4-5C	8	-05	5/16	7.9	1/4" - 18	2.78	71	1.18	30	0.630	16	15,000	1,030
601LX-6-5	8	-05	5/16	7.9	3/8" - 18	3.96	75	1.37	35	0.750	19	15,000	1,030
601LX-6-5C	8	-05	5/16	7.9	3/8" - 18	3.96	75	1.37	35	0.750	19	15,000	1,030
601LX-8-8	12	-08	1/2	12.7	1/2" - 14	3.75	95	1.70	43	1.130	29	15,000	1,030
601LX-8-8C	12	-08	1/2	12.7	1/2" - 14	3.75	95	1.70	43	1.130	29	15,000	1,030
601LX-12-12C	20	-12	3/4	19.0	3/4" - 14	4.75	121	2.10	53	1.380	35	10,000	690
601LX-16-12C	20	-12	3/4	19.0	1" - 11 1/2	4.90	124	2.25	57	1.380	35	10,000	690
601LX-16-16C	25	-16	1	25.4	1" - 11 1/2	5.00	125	2.50	64	1.380	35	10,000	690

## 606LX- JIC 37° Female Flare

Material: Nipple - High strength stainless steel  
 Shell - Stainless steel  
 Nut - Stainless steel

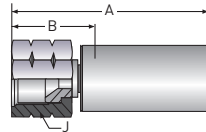

Part Number	Nominal I.D.				Thread Size	A Overall Length		B Cutoff Allowance		J Hex		Maximum Working Pressure	
	DN	Size	inch	mm		inch	mm	inch	mm	inch	mm	psi	bar
#													
606LX-6-5C	8	-05	5/16	7.9	9/16"-18	2.70	69	1.10	28	0.75	19	10,000	690
606LX-8-5C	8	-05	5/16	7.9	3/4" - 16	2.82	72	1.22	31	1.00	25	10,000	690
606LX-8-8C	12	-08	1/2	12.7	3/4" - 16	3.80	96	1.75	44	1.063	27	10,000	690
606LX-16-12C	20	-12	3/4	19.0	1-5/16" - 12	4.29	109	1.68	43	1.50	38	10,000	690
606LX-16-16C	25	-16	1	25.4	1-5/16" - 12	3.79	96	1.65	42	1.50	38	10,000	690



**WARNING**

This product can expose you to chemicals including Lead, which is known to the State of California to cause cancer and birth defects or other reproductive harm. For more information go to [www.P65Warnings.ca.gov](http://www.P65Warnings.ca.gov).

# LX Series Fittings

## 106LX- JIC 37° Female Flare

Material: Nipple - Carbon steel, zinc-plated C - Stainless steel  
 Shell - Carbon steel, zinc-plated C - Stainless steel  
 Nut - Carbon steel, zinc-plated C / SUBSEA - Stainless steel

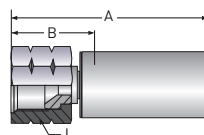

Part Number	Nominal I.D.				Thread Size	A Overall Length		B Cutoff Allowance		J Hex		Maximum Working Pressure	
	DN	Size	inch	mm		inch	mm	inch	mm	inch	mm	psi	bar
#													
106LX-6-04C	6	-04	1/4	6.4	9/16"-18	3.03	77	1.26	32	0.75	19	10,000	690
106LX-6-05C	8	-05	5/16	7.9	9/16"-18	3.07	78	1.30	33	0.75	19	10,000	690
106LX-6-06C	10	-06	3/8	9.5	9/16"-18	3.00	76	1.26	32	0.87	22	10,000	690
106LX-8-08	12	-08	1/2	12.7	3/4" - 16	2.52	64	0.83	21	1.06	27	10,000	690
106LX-8-08C	12	-08	1/2	12.7	3/4" - 16	2.52	64	0.83	21	1.06	27	10,000	690
106LX-6-06C-M-SUBSEA	10	-06	3/8	9.5	9/16"-18	2.32	59	0.71	18	0.87	22	10,000	690
106LX-8-06C-M-SUBSEA	10	-06	3/8	9.5	3/4"-16	2.32	59	0.75	19	0.94	24	10,000	690
106LX-8-08C-M-SUBSEA	12	-08	1/2	12.7	3/4"-16	2.52	64	0.83	21	1.06	27	10,000	690
106LX-16-12C4462	20	-12	3/4	19.0	1-5/16"-12UNF	3.99	99	1.69	43	1.61	41	10,000	690
106LX-16-16C4462	25	-16	1	25.4	1-5/16"-12	3.03	77	1.00	25	1.61	41	5,000	350



### WARNING

This product can expose you to chemicals including Lead, which is known to the State of California to cause cancer and birth defects or other reproductive harm. For more information go to [www.P65Warnings.ca.gov](http://www.P65Warnings.ca.gov).

# LX Series Fittings

## 192LX- BSP Swivel - Female

Material: Nipple - Stainless steel  
Shell - Stainless steel  
Nut - Stainless steel

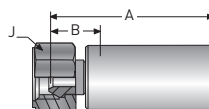

Part Number	Nominal I.D.				Thread Size	A Overall Length		B Cutoff Allowance		J Hex		Maximum Working Pressure*	
	DN	Size	inch	mm		inch	mm	inch	mm	inch	mm	psi	bar
#													
192LX-8-08C	12	-08	1/2	12.7	G 1/2" - 14 BSPP	2.95	75	0.82	21	1.18	30	—	—

\* Fitting is rated to the full working pressure of the hose

## 65YLX- Medium Pressure Female Swivel

Material: Nipple - High strength steel  
C - High strength stainless steel  
Shell - Carbon steel, zinc-plated  
Nut - Stainless steel

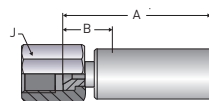

Part Number	Nominal I.D.				Thread Size	A Overall Length		B Cutoff Allowance		J Hex		Maximum Working Pressure	
	DN	Size	inch	mm		inch	mm	inch	mm	inch	mm	psi	bar
#													
65YLX-6-3	5	-03	3/16	4.8	9/16"-18	3.08	78	1.53	39	0.75	19	20,000	1,380
65YLX-6-3C	5	-03	3/16	4.8	9/16"-18	3.20	81	1.67	42	0.75	19	20,000	1,380
65YLX-6-4C	6	-04	1/4	6.4	9/16"-18	2.84	72	1.54	39	0.75	19	20,000	1,380

## 66YLX- High Pressure Female Swivel

Material: Nipple - High strength steel  
C - High strength stainless steel  
Shell - Carbon steel, zinc-plated  
Nut - Stainless steel

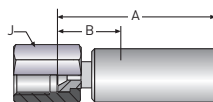

Part Number	Nominal I.D.				Thread Size	A Overall Length		B Cutoff Allowance		J Hex		Maximum Working Pressure*	
	DN	Size	inch	mm		inch	mm	inch	mm	inch	mm	psi	bar
#													
66YLX-4-3	5	-03	3/16	4.8	9/16"-18	2.80	71	1.28	33	0.75	19	—	—
66YLX-4-3C	5	-03	3/16	4.8	9/16"-18	2.93	74	1.42	36	0.68	17	—	—

\* Fitting is rated to the full working pressure of the hose



### WARNING

This product can expose you to chemicals including Lead, which is known to the State of California to cause cancer and birth defects or other reproductive harm. For more information go to [www.P65Warnings.ca.gov](http://www.P65Warnings.ca.gov).

# LX Series Fittings

## 1AYLX- Type "M" Swivel - Female

Material: Nipple - Carbon steel, zinc-plated  
 C - Stainless steel  
 Shell - Carbon steel, zinc-plated  
 C - Stainless steel  
 Nut - Carbon steel, zinc-plated  
 C - Stainless steel

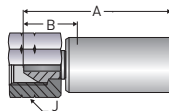

Part Number	Nominal I.D.			Thread Size	A Overall Length		B Cutoff Allowance		J Hex		Maximum Working Pressure*		
#	⊙			⌀					⬡		↻		
	DN	Size	inch	mm	inch	mm	inch	mm	inch	mm	psi	bar	
1AYLX-6-02	3	-02	1/8	3.2	9/16"-18	1.89	48	1.02	26	0.87	22	—	—
1AYLX-6-04	6	-04	1/4	6.4	9/16"-18	2.40	61	1.13	29	0.87	22	—	—
1AYLX-6-04C	6	-04	1/4	6.4	9/16"-18	2.40	61	1.13	29	0.87	22	—	—
1AYLX-8-05C	8	-05	5/16	7.9	3/4" - 16	2.76	70	1.22	31	1.06	27	—	—
1AYLX-8-06C4462	12	-08	1/2	12.7	3/4"-16	2.76	70	0.98	25	1.06	27	—	—
1AYLX-11-08	12	-08	1/2	12.7	1" - 12	3.19	81	1.06	27	1.26	32	—	—
1AYLX-11-08C	12	-08	1/2	12.7	1" - 12	3.19	81	1.06	27	1.26	32	—	—

\* Fitting is rated to the full working pressure of the hose



### WARNING

This product can expose you to chemicals including Lead, which is known to the State of California to cause cancer and birth defects or other reproductive harm. For more information go to [www.P65Warnings.ca.gov](http://www.P65Warnings.ca.gov).

# LX Series Fittings

## 6AYLX - Type "M" Swivel - Female

Material: Nipple - High strength steel  
 C - High strength stainless steel  
 SD / HCL / SUBSEA - High strength, corrosion-resistant stainless steel

Shell - Carbon steel, zinc-plated  
 C / SD / HCL / SUBSEA - Stainless steel

Nut - Stainless steel

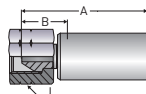

Part Number	Nominal I.D.				Thread Size	A Overall Length		B Cutoff Allowance		J Hex		Maximum Working Pressure*	
	DN	Size	inch	mm		inch	mm	inch	mm	inch	mm	psi	bar
#	⊙				⚓					⬡		↻	
6AYLX-6-2AC	4	-025	5/32	4.0	9/16"-18	2.51	64	1.28	33	0.68	17	—	—
6AYLX-6-3	5	-03	3/16	4.8	9/16"-18	2.80	71	1.28	33	0.75	19	—	—
6AYLX-6-3C	5	-03	3/16	4.8	9/16"-18	2.93	74	1.42	36	0.68	17	—	—
6AYLX-6-4	6	-04	1/4	6.4	9/16"-18	2.69	68	1.39	35	0.68	17	—	—
6AYLX-6-4C	6	-04	1/4	6.4	9/16"-18	2.69	68	1.39	35	0.68	17	—	—
6AYLX-8-6C	10	-06	3/8	9.5	3/4"-16	2.95	75	1.25	32	1.00	25	—	—
6AYLX-11-8C	12	-08	1/2	12.7	1" - 12	3.53	90	1.50	38	1.25	32	—	—
6AYLX-11-8C-SD	12	-08	1/2	12.7	1" - 12	3.53	90	1.50	38	1.25	32	—	—
6AYLX-16-12C	20	-12	3/4	19.0	1-5/16" - 12	4.15	105	1.52	39	1.50	38	—	—
6AYLX-16-12C-SD	20	-12	3/4	19.0	1-5/16" - 12	4.29	109	1.64	42	1.50	38	—	—
6AYLX-16-16C	25	-16	1	25.4	1-5/16" - 12	5.45	139	2.04	52	1.50	38	—	—
6AYLX-16-16C-SD	25	-16	1	25.4	1-5/16" - 12	5.45	139	2.04	52	1.50	38	—	—
6AYLX-16-16-HCL	25	-16	1	25.4	1-5/16" - 12	5.45	139	2.04	52	1.50	38	—	—
6AYLX-8-5C-M-SUBSEA	8	-05	5/16	7.9	3/4"-16	3.65	93	1.76	45	0.88	22	—	—
6AYLX-8-6C-M-SUBSEA	10	-06	3/8	9.5	3/4"-16	3.23	82	1.45	37	1.00	25	—	—

\* Fitting is rated to the full working pressure of the hose

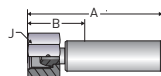

## Type "M" Swivel - Female (Ball Nose)

	DN	Size	inch	mm		inch	mm	inch	mm	inch	mm	psi	bar
6AYLX-8-5C	8	-05	5/16	7.9	3/4" - 16	2.82	72	1.22	31	1.00	25	—	—

\* Fitting is rated to the full working pressure of the hose



### WARNING

This product can expose you to chemicals including Lead, which is known to the State of California to cause cancer and birth defects or other reproductive harm. For more information go to [www.P65Warnings.ca.gov](http://www.P65Warnings.ca.gov).

# LX Series Fittings

## 6C9LX- Metric Swivel - Female

Material: Nipple - High strength stainless steel  
 Shell - Stainless steel  
 Nut - Carbon steel, zinc-plated

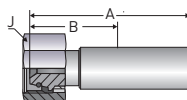

Part Number	Nominal I.D.				Thread Size	A Overall Length		B Cutoff Allowance		J Hex		Maximum Working Pressure*	
#													
	DN	Size	inch	mm		inch	mm	inch	mm	inch	mm	psi	bar
6C9LX-16-8	12	-08	1/2	12.7	M 24 x 1.5	3.48	88	1.44	37	1.26	32	—	—
6C9LX-25-12	20	-12	3/4	19.0	M 36 x 2	4.26	108	1.58	40	1.81	46	—	—
6C9LX-30-16C	25	-16	1	25.4	M 42 x 2	4.65	118	2.05	52	1.97	50	—	—

\* Fitting is rated to the full working pressure of the hose

## 1C9LX- Metric Swivel - Female

Material: Nipple - Stainless steel  
 Shell - Stainless steel  
 Nut - Stainless steel

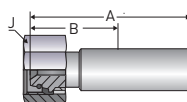

Part Number	Nominal I.D.				Thread Size	A Overall Length		B Cutoff Allowance		J Hex		Maximum Working Pressure*	
#													
	DN	Size	inch	mm		inch	mm	inch	mm	inch	mm	psi	bar
1C9LX-16-08C	12	-08	1/2	12.7	M 24 x 1.5	3.46	88	1.34	34	1.26	32	—	—

\* Fitting is rated to the full working pressure of the hose



### WARNING

This product can expose you to chemicals including Lead, which is known to the State of California to cause cancer and birth defects or other reproductive harm. For more information go to [www.P65Warnings.ca.gov](http://www.P65Warnings.ca.gov).

# LX Series Fittings

## 6HELX- Hammer Union (Male) Cone w/ Wing Nut

Material: Nipple - High strength steel  
 Shell - Stainless steel  
 Nut - Carbon steel

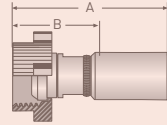

Part Number	Nominal I.D.				Thread Size	A Overall Length		B Cutoff Allowance		Maximum Working Pressure	
	DN	Size	inch	mm		inch	mm	inch	mm	psi	bar
#	⊙				⋈					↗	
6HELX-16-16-HCL	25	-16	1	25.4	2-5/16"-3.5 ACME	6.00	153	3.63	92	15,000	1,030

## 6HNLX- Hammer Union (Female) Cone Threaded End w/ Seal

Material: Nipple - High strength steel  
 Shell - Stainless steel

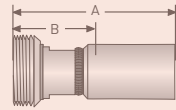

Part Number	Nominal I.D.				Thread Size	A Overall Length		B Cutoff Allowance		Maximum Working Pressure	
	DN	Size	inch	mm		inch	mm	inch	mm	psi	bar
#	⊙				⋈					↗	
6HNLX-16-16-HCL	25	-16	1	25.4	2-5/16"-3.5 ACME	6.00	153	3.63	92	15,000	1,030



**WARNING**

This product can expose you to chemicals including Lead, which is known to the State of California to cause cancer and birth defects or other reproductive harm. For more information go to [www.P65Warnings.ca.gov](http://www.P65Warnings.ca.gov).



# LX Series Fittings

## 6HYLX- Waterblast Nozzle - Female

Material: Nipple - High strength stainless steel  
Shell - Stainless steel

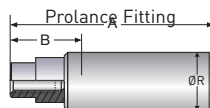

Part Number	Nominal I.D.				Thread Size		A Overall Length		B Cutoff Allowance		R Diameter		Maximum Working Pressure	
	DN	Size	inch	mm			inch	mm	inch	mm	inch	mm	psi	bar
#														
6HYLX-4-2AC-PL	4	-025	5/32	4.0	1/4"-28 UNF		2.01	51	0.75	19	0.35	9	—	—
6HYLX-4-2AC-PL-LH	4	-025	5/32	4.0	1/4"-28 UNF LH		2.01	51	0.75	19	0.35	9	—	—
6HYLX-6-2AC-PL-LH	4	-025	5/32	4.0	3/8"-24 UNF LH		1.93	49	0.83	21	0.43	11	—	—
6HYLX-4-3C-PL	5	-03	3/16	4.8	1/4"-28 UNF		2.05	52	0.75	19	0.35	9	—	—
6HYLX-4-3C-PL-LH	5	-03	3/16	4.8	1/4"-28 UNF LH		2.05	52	0.75	19	0.35	9	—	—
6HYLX-6-3C-PL	5	-03	3/16	4.8	3/8"-24 UNF		2.20	56	0.91	23	0.43	11	—	—
6HYLX-6-3C-PL-LH	5	-03	3/16	4.8	3/8"-24 UNF LH		2.20	56	0.91	23	0.43	11	—	—
6HYLX-6-4C-PL	5	-04	1/4	6.4	3/8" - 24 UNF		2.28	58	0.98	25	0.43	11	—	—
6HYLX-6-4C-PL-LH	5	-04	1/4	6.4	3/8"-24 UNF LF		2.28	58	0.98	25	0.43	11	—	—
6HYLX-9-5C-PL	8	-05	5/16	7.9	9/16"-18 UNF		2.83	72	1.10	28	0.67	17	—	—
6HYLX-9-5C-PL-LH	8	-05	5/16	7.9	9/16"-18 UNF LH		2.83	72	1.10	28	0.67	17	—	—

Note: \*Fitting is rated to the full working pressure of the hose

## 6Y2LX- Medium Pressure - Male

Material: Nipple - High strength stainless steel  
Shell - Stainless steel

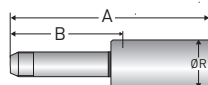

Part Number	Nominal I.D.				Thread Size		A Overall Length		B Cutoff Allowance		R Diameter		Maximum Working Pressure	
	DN	Size	inch	mm			inch	mm	inch	mm	inch	mm	psi	bar
#														
6Y2LX-9-5C	8	-05	5/16	7.9	9/16"-18 LH		2.60	66	0.88	22	0.82	21	20,000	1,380
6Y2LX-9-8C	12	-08	1/2	12.7	9/16"-18 LH		4.20	107	2.20	56	1.13	29	20,000	1,380
6Y2LX-12-8C	12	-08	1/2	12.7	3/4"-16 LH		4.13	105	2.08	53	1.13	29	20,000	1,380
6Y2LX-16-12C	20	-12	3/4	19.0	1"-14 LH		5.39	137	2.75	70	1.56	40	20,000	1,380



### WARNING

This product can expose you to chemicals including Lead, which is known to the State of California to cause cancer and birth defects or other reproductive harm. For more information go to [www.P65Warnings.ca.gov](http://www.P65Warnings.ca.gov).

# LX Series Fittings

## 1Y2LX- Medium Pressure - Male

Material: Nipple - Carbon steel, zinc-plated  
 C - Stainless steel  
 SUBSEA - High strength stainless steel  
 Shell - Carbon steel, zinc-plated  
 C - Stainless steel

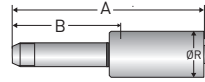

Part Number	Nominal I.D.				Thread Size	A Overall Length		B Cutoff Allowance		R Diameter		Maximum Working Pressure	
	DN	Size	inch	mm		inch	mm	inch	mm	inch	mm	psi	bar
#													
1Y2LX-6-04	6	-04	1/4	6.4	3/8" - 24 LH	4.72	120	2.56	65	0.67	17	20,000	1,380
1Y2LX-9-08C	12	-08	1/2	12.7	9/16" - 18 LH	4.33	110	2.36	60	1.22	31	20,000	1,380
1Y2LX-12-08C	12	-08	1/2	12.7	3/4 - 16 LH	6.22	158	4.09	104	1.22	31	20,000	1,380
1Y2LX-12-08C-M-SUBSEA	12	-08	1/2	12.7	3/4 - 16 LH	7.25	184	4.70	119	1.30	33	20,000	1,380
1Y2LX-16-16C4462	25	-16	1	25.4	1" - 14 LH	7.13	181	5.00	127	1.06	27	20,000	1,380

## 6Y4LX- High Pressure - Male

Material: Nipple - High strength stainless steel  
 Shell - Stainless steel

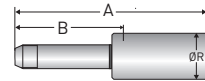

Part Number	Nominal I.D.				Thread Size	A Overall Length		B Cutoff Allowance		R Diameter		Maximum Working Pressure	
	DN	Size	inch	mm		inch	mm	inch	mm	inch	mm	psi	bar
#													
6Y4LX-4-2AC	4	-025	5/32	4.0	1/4" - 28 LH	2.96	75	1.71	43	0.63	16	—	—
6Y4LX-6-2AC	4	-025	5/32	4.0	3/8" - 24 LH	3.40	86	2.16	55	0.63	16	—	—
6Y4LX-9-3C	5	-03	3/16	4.8	9/16" - 18 LH	4.20	107	2.70	69	0.67	17	—	—



**WARNING**

This product can expose you to chemicals including Lead, which is known to the State of California to cause cancer and birth defects or other reproductive harm. For more information go to [www.P65Warnings.ca.gov](http://www.P65Warnings.ca.gov).

# LX Series Fittings

## 1Y4LX- High Pressure - Male

Material: Nipple - Carbon steel, zinc-plated  
 C - Stainless steel  
 Shell - Carbon steel, zinc-plated  
 C - Stainless steel

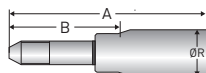

Part Number	Nominal I.D.				Thread Size	A Overall Length		B Cutoff Allowance		R Diameter		Maximum Working Pressure	
	DN	Size	inch	mm		inch	mm	inch	mm	inch	mm	psi	bar
#													
1Y4LX-4-02	3	-2	1/8	3.2	1/4" - 28 LH	2.47	63	1.57	40	0.43	11	—	—
1Y4LX-9-08C	12	-8	1/2	12.7	9/16" - 18 LH	4.88	124	2.75	70	1.38	35	—	—

## 6YHLX- Waterblast Nozzle - Male

Material: Nipple - High strength stainless steel  
 Shell - Stainless steel

Prolance Fitting.



Part Number	Nominal I.D.				Thread Size	A Overall Length		B Cutoff Allowance		R Diameter		Maximum Working Pressure*	
	DN	Size	inch	mm		inch	mm	inch	mm	inch	mm	psi	bar
#													
6YHLX-4-2AC-PL	4	-025	5/32	4	1/4" - 28 UNF	2.28	58	1.02	26	0.50	13	—	—
6YHLX-4-2AC-PL-LH	4	-025	5/32	4	1/4" - 28 UNF LH	2.28	58	1.02	26	0.50	13	—	—
6YHLX-4-3C-PL	5	-03	3/16	4.8	1/4" - 28 UNF	2.44	62	1.14	29	0.60	15	—	—
6YHLX-4-3C-PL-LH	5	-03	3/16	4.8	1/4" - 28 UNF LH	2.44	62	1.14	29	0.60	15	—	—
6YHLX-6-3C-PL	5	-03	3/16	4.8	3/8" - 24 UNF	2.56	65	1.26	32	0.60	15	—	—
6YHLX-6-3C-PL-LH	5	-03	3/16	4.8	3/8" - 24 UNF LH	2.56	65	1.26	32	0.60	15	—	—
6HYLX-6-4C-PL	6	-04	1/4	6.4	3/8" - 24 UNF	2.60	66	1.42	36	0.67	17	—	—
6HYLX-6-4C-PL-LH	6	-04	1/4	6.4	3/8" - 24 UNF LH	2.60	66	1.42	36	0.67	17	—	—
6YHLX-9-5C-PL	8	-05	5/16	7.9	9/16" - 18 UNF	3.15	80	1.42	36	0.80	20	—	—
6YHLX-9-5C-PL-LH	8	-05	5/16	7.9	9/16" - 18 UNF LH	3.15	80	1.42	36	0.80	20	—	—

Note: \*Fitting is rated to the full working pressure of the hose



### WARNING

This product can expose you to chemicals including Lead, which is known to the State of California to cause cancer and birth defects or other reproductive harm. For more information go to [www.P65Warnings.ca.gov](http://www.P65Warnings.ca.gov).

# LX Series Fittings

## 1YHLX- Waterblast Nozzle - Male

Material: Nipple - High strength stainless steel  
Shell - Carbon steel, zinc-plated

SC - Nipple - Carbon steel, zinc plated  
Shell - Stainless steel

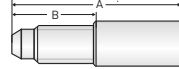

Part Number	Nominal I.D.				Thread Size	A Overall Length		B Cutoff Allowance		R Diameter		Maximum Working Pressure*	
	DN	Size	inch	mm		inch	mm	inch	mm	inch	mm	psi	bar
#													
1YHLX-9-06SC	10	-6	3/8	9.5	9/16"-18 LH	3.126	79	1.34	34	1.06	27	-	-

Note: \*Fitting is rated to the full working pressure of the hose



**WARNING**

This product can expose you to chemicals including Lead, which is known to the State of California to cause cancer and birth defects or other reproductive harm. For more information go to [www.P65Warnings.ca.gov](http://www.P65Warnings.ca.gov).

# NX Series Fittings

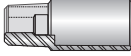
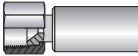
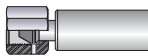



NX Series Crimp Fittings	01	*NPT - Male Prolance	06	JIC 37° Flare - Female	AY	Type "M" Swivel - Female
	 B-57		 B-58		 B-59	

## 601NX- NPT Male

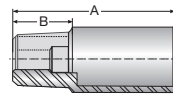
Material: Nipple - Carbon steel  
C - Stainless steel  
Shell - Carbon steel  
C - Stainless steel

\* Prolance Fitting





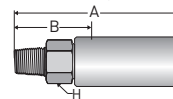

Part Number	Nominal I.D.				Thread Size	A Overall Length		B Cutoff Allowance		H Hex		Maximum Working Pressure	
	DN	Size	inch	mm		inch	mm	inch	mm	inch	mm	psi	bar
#													
601NX-4-4*	6	-04	1/4	6.4	1/4" - 18	1.56	40	1.35	34	NA	NA	15,000	1,030

## 101NX- NPT Male

Material: Nipple - Carbon steel, zinc-plated  
Shell - Carbon steel, zinc-plated



Part Number	Nominal I.D.				Thread Size	A Overall Length		B Cutoff Allowance		H Hex		Maximum Working Pressure	
	DN	Size	inch	mm		inch	mm	inch	mm	inch	mm	psi	bar
#													
101NX-4-04	6	-04	1/4	6.4	1/4" - 18	2.57	65	1.35	34	0.63	16	15,000	1,030
101NX-6-06	10	-06	3/8	9.5	3/8" - 18	2.79	71	1.20	30	0.87	22	15,000	1,030
101NX-8-08	12	-08	1/2	12.7	1/2" - 14	3.11	79	1.46	37	0.87	22	15,000	1,030
101NX-12-12	20	-12	3/4	19.0	3/4" - 14	3.66	93	1.57	40	1.06	27	10,000	690



### WARNING

This product can expose you to chemicals including Lead, which is known to the State of California to cause cancer and birth defects or other reproductive harm. For more information go to [www.P65Warnings.ca.gov](http://www.P65Warnings.ca.gov).

Hose  
 A  
 Fittings  
 B  
 Adapters & Valves  
 C  
 Quick Couplings  
 D  
 Accessories  
 E  
 General Technical  
 F

# NX Series Fittings

## 606NX- JIC 37° Female Flare

Material: Nipple - Stainless steel  
 Shell - Stainless steel  
 Nut - Stainless steel

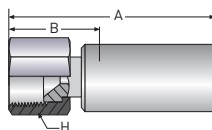

Part Number	Nominal I.D.				Thread Size	A Overall Length		B Cutoff Allowance		H Hex		Maximum Working Pressure	
	DN	Size	inch	mm		inch	mm	inch	mm	inch	mm	psi	bar
#	○				⚡					⬡		↻	
606NX-4-4C	6	-04	1/4	6.4	7/16" - 20	2.23	57	0.99	25	0.63	16	10,000	690
606NX-6-4C	6	-04	1/4	6.4	9/16" - 18	2.36	60	1.11	28	0.68	17	10,000	690

## 106NX- JIC 37° Female Flare

Material: Nipple - Carbon steel, zinc-plated  
 Shell - Carbon steel, zinc-plated  
 Nut - Carbon steel, zinc-plated

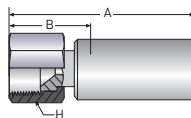

Part Number	Nominal I.D.				Thread Size	A Overall Length		B Cutoff Allowance		H Hex		Maximum Working Pressure	
	DN	Size	inch	mm		inch	mm	inch	mm	inch	mm	psi	bar
#	○				⚡					⬡		↻	
106NX-4-04	6	-04	1/4	6.4	7/16" - 20	2.56	65	1.37	35	0.75	19	10,000	690
106NX-6-04	6	-04	1/4	6.4	9/16" - 18	2.56	65	1.32	34	0.75	19	10,000	690
106NX-6-06	10	-06	3/8	9.5	9/16" - 18	2.56	65	1.32	34	0.75	19	10,000	690
106NX-8-06	10	-06	3/8	9.5	3/4" - 16	2.82	72	1.23	31	0.95	24	10,000	690
106NX-8-08	12	-08	1/2	12.7	3/4" - 16	2.52	64	0.83	21	1.06	27	10,000	690
106NX-12-12	20	-12	3/4	19.0	1-1/16" - 12	3.78	96	1.69	43	1.42	36	5,000	345
106NX-16-12	20	-12	3/4	19.0	1-5/16" - 12	3.66	93	1.57	40	1.61	41	4,000	275
106NX-16-16	25	-16	1	25.4	1-5/16" - 12	3.84	98	1.67	43	1.61	41	4,000	275
106NX-20-20	32	-20	1-1/4	31.8	1-5/8" - 12	4.09	104	1.73	44	1.97	50	4,000	275



**WARNING**

This product can expose you to chemicals including Lead, which is known to the State of California to cause cancer and birth defects or other reproductive harm. For more information go to [www.P65Warnings.ca.gov](http://www.P65Warnings.ca.gov).

# NX Series Fittings

## 6AYNX- Type "M" Swivel - Female

Material: Nipple - Stainless steel  
 Shell - Stainless steel  
 Nut - Stainless steel

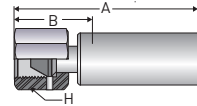

Part Number	Nominal I.D.				Thread Size	A Overall Length		B Cutoff Allowance		H Hex		Maximum Working Pressure*	
	DN	Size	inch	mm		inch	mm	inch	mm	inch	mm	psi	bar
#													
6AYNX-6-4C	6	-04	1/4	6.4	9/16"-18	2.36	60	1.11	28	0.68	17	—	—

\* Fitting is rated to the full working pressure of the hose

Hose  
A

Fittings  
B

Adapters & Valves  
C

Quick Couplings  
D

Accessories  
E

General Technical  
F



### WARNING

This product can expose you to chemicals including Lead, which is known to the State of California to cause cancer and birth defects or other reproductive harm. For more information go to [www.P65Warnings.ca.gov](http://www.P65Warnings.ca.gov).



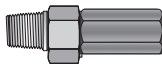
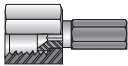
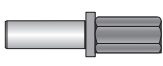

# RX Series Field Attachable Fittings

RX Series	01	NPT - Male	06	JIC 37° Flare - Female	TU	Tube Stub Fitting
		B-60		B-60		B-60

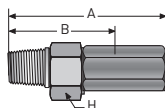
## 201RX- NPT Male

Material: Nipple - Stainless steel  
Shell - Stainless steel





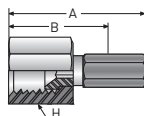

Part Number	Nominal I.D.				Thread Size	A Overall Length		B Cutoff Allowance		H Hex		Maximum Working Pressure	
	DN	Size	inch	mm		inch	mm	inch	mm	inch	mm	psi	bar
#													
201RX-2-2C	3	-02	1/8	3.2	1/8" - 27	1.54	39	1.10	28	0.44	11	15,000	1,030

## 206RX- JIC 37° Female Flare

Material: Nipple - Stainless steel  
Shell - Stainless steel





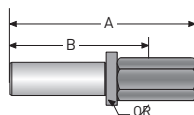

Part Number	Nominal I.D.				Thread Size	A Overall Length		B Cutoff Allowance		H Hex		Maximum Working Pressure	
	DN	Size	inch	mm		inch	mm	inch	mm	inch	mm	psi	bar
#													
206RX-4-2C	3	-02	1/8	3.2	7/16" - 20	1.56	40	1.10	28	0.56	14	10,000	690

## 2TURX- Tube Stub

Material: Nipple - Stainless steel  
Shell - Stainless steel



Part Number	Nominal I.D.				Thread Size	A Overall Length		B Cutoff Allowance		R Diameter		Maximum Working Pressure*	
	DN	Size	inch	mm		inch	mm	inch	mm	inch	mm	psi	bar
#													
2TURX-4-2C	3	-02	1/8	3.2	1/4" TUBE	1.65	42	1.20	30	0.38	10	—	—

\* Fitting is rated to the full working pressure of the hose



### WARNING

This product can expose you to chemicals including Lead, which is known to the State of California to cause cancer and birth defects or other reproductive harm. For more information go to [www.P65Warnings.ca.gov](http://www.P65Warnings.ca.gov).

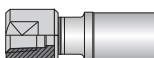
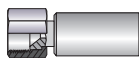
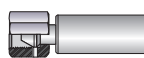
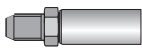

# TX Series Fittings

TX Series Crimp Fittings	<b>01</b> NPT - Male	<b>02</b> NPT - Female	<b>06</b> JIC 37° Flare - Female	<b>AY</b> Type "M" Swivel - Female
	 B-61	 B-62	 B-62	 B-63
	<b>YH</b> Waterblast Nozzle - Male			
	 B-63			

## 101TX- NPT Male

Material: Nipple - Carbon steel, zinc-plated  
Shell - Carbon steel, zinc-plated

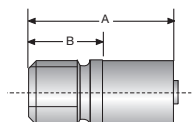

Part Number	Nominal I.D.				Thread Size	A Overall Length		B Cutoff Allowance		Maximum Working Pressure	
	#	DN	Size	inch		mm	inch	mm	inch	mm	psi
101TX-1-02-PL	3	-02	1/8	3.2	1/16"-27	0.95	24	0.41	10	15,000	1,030
101TX-2-02-PL	3	-02	1/8	3.2	1/8"-27	0.95	24	.041	10	15,000	1,030
101TX-1-025-PL	4	-025	5/32	4.0	1/16"-27	1.04	27	0.43	11	15,000	1,030
101TX-2-025-PL	4	-025	5/32	4.0	1/8" - 27	1.04	27	0.43	11	15,000	1,030
101TX-2-03-PL	5	-03	3/16	4.8	1/8" - 27	1.04	27	0.45	12	15,000	1,030
101TX-4-03-PL	5	-03	3/16	4.8	1/4" - 18	1.22	31	0.63	16	15,000	1,030
101TX-2-04-PL	6	-04	1/4	6.4	1/8" - 27	1.14	29	0.47	12	15,000	1,030
101TX-4-04-PL	6	-04	1/4	6.4	1/4" - 18	1.30	33	0.63	16	15,000	1,030
101TX-4-05-PL	8	-05	5/16	7.9	1/4" - 18	1.42	36	0.55	14	15,000	1,030
101TX-6-05-PL	8	-05	5/16	7.9	3/8" - 18	1.48	38	0.62	16	15,000	1,030



### WARNING

This product can expose you to chemicals including Lead, which is known to the State of California to cause cancer and birth defects or other reproductive harm. For more information go to [www.P65Warnings.ca.gov](http://www.P65Warnings.ca.gov).

# TX Series Fittings

## 102TX- NPT Female

Material: Nipple - Carbon steel, zinc-plated  
Shell - Carbon steel, zinc-plated

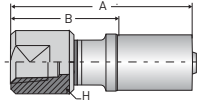

Part Number	Nominal I.D.				Thread Size	A Overall Length		B Cutoff Allowance		H Wrench Flats		Maximum Working Pressure	
	DN	Size	inch	mm		inch	mm	inch	mm	inch	mm	psi	bar
#													
102TX-4-04-PL	6	-04	1/4	6.40	1/4" - 18	1.77	45	1.10	28	0.47	12	15,000	1,030

## 106TX- JIC 37° Female Flare

Material: Nipple - Carbon steel, zinc-plated  
Shell - Carbon steel, zinc-plated  
Nut - Carbon steel, zinc-plated

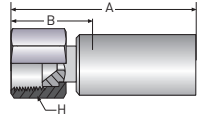

Part Number	Nominal I.D.				Thread Size	A Overall Length		B Cutoff Allowance		H Hex		Maximum Working Pressure	
	DN	Size	inch	mm		inch	mm	inch	mm	inch	mm	psi	bar
#													
106TX-4-025W	4	-025	5/32	4.0	7/16" - 20	1.73	44	0.83	21	0.68	17	10,000	690
106TX-4-03W	5	-03	3/16	4.8	7/16" - 20	2.64	67	1.58	40	0.75	19	10,000	690
106TX-4-04W	6	-04	1/4	6.4	7/16" - 20	2.64	67	1.58	40	0.75	19	10,000	690
106TX-6-04W	6	-04	1/4	6.4	9/16" - 18	2.09	53	1.02	26	0.75	19	10,000	690



**WARNING**

This product can expose you to chemicals including Lead, which is known to the State of California to cause cancer and birth defects or other reproductive harm. For more information go to [www.P65Warnings.ca.gov](http://www.P65Warnings.ca.gov).

# TX Series Fittings

## 1AYTX- Type "M" Swivel - Female

Material: Nipple - Carbon steel, zinc-plated  
 Shell - Carbon steel, zinc-plated  
 Nut - Carbon steel, zinc-plated

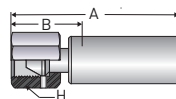

Part Number	Nominal I.D.				Thread Size	A Overall Length		B Cutoff Allowance		H Hex		Maximum Working Pressure*		
#														
	DN	Size	inch	mm			inch	mm	inch	mm	inch	mm	psi	bar
1AYTX-6-025W	4	-025	5/32	4.0	9/16"-18		1.77	45	0.91	23	0.75	19	—	—
1AYTX-6-03W	5	-03	3/16	4.8	9/16"-18		1.97	50	0.91	23	0.75	19	—	—
1AYTX-6-04W	6	-04	1/4	6.4	9/16"-18		2.05	52	0.99	25	0.75	19	—	—
1AYTX-8-05W	8	-05	5/16	7.9	3/4"-16		2.52	64	1.18	30	1.06	27	—	—

\* Fitting is rated to the full working pressure of the hose

## 1YHTX- Waterblast Nozzle - Male

Material: Nipple - Carbon steel, zinc-plated  
 Shell - Carbon steel, zinc-plated

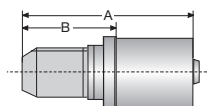

Part Number	Nominal I.D.				Thread Size	A Overall Length		B Cutoff Allowance		H Wrench Flats		Maximum Working Pressure*		
#														
	DN	Size	inch	mm			inch	mm	inch	mm	inch	mm	psi	bar
1YHTX-4-025-PL	4	-025	5/32	4.0	1/4" - 28		1.56	40	0.95	24	0.32	8	—	—
1YHTX-4-025-PL-LH	4	-025	5/32	4.0	1/4" - 28 LH		1.56	40	0.95	24	0.32	8	—	—
1YHTX-6-03-PL	5	-03	3/16	4.8	3/8" - 24		1.34	34	0.74	19	0.35	9	—	—
1YHTX-6-05W-LH	8	-05	3/16	7.9	3/8" - 24 LH		2.56	65	1.30	33	0.51	13	—	—
1YHTX-6-03-PL-LH	5	-03	3/16	4.8	3/8" - 24 LH		1.34	34	0.74	19	0.35	9	—	—

\* Fitting is rated to the full working pressure of the hose



### WARNING

This product can expose you to chemicals including Lead, which is known to the State of California to cause cancer and birth defects or other reproductive harm. For more information go to [www.P65Warnings.ca.gov](http://www.P65Warnings.ca.gov).

# UX Series Fittings

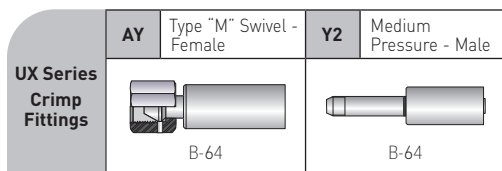

## 1AYUX- Type "M" Swivel - Female

Material: Nipple - Stainless steel  
Shell - Stainless steel

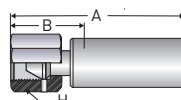

Part Number	Nominal I.D.				Thread Size	A Overall Length		B Cutoff Allowance		H Hex		Maximum Working Pressure*	
	DN	Size	inch	mm		inch	mm	inch	mm	inch	mm	psi	bar
#													
1AYUX-6-04C	6	-04	1/4	6.4	9/16"-18	3.66	93	1.38	35	0.75	19	—	—
1AYUX-8-06C	10	-06	3/8	9.5	3/4"-16	3.94	100	1.39	35	1.06	27	—	—

\* Fitting is rated to the full working pressure of the hose

## 1Y2UX- Medium Pressure - Male

Material: Nipple - Stainless steel  
Shell - Stainless steel

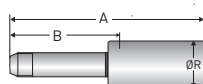



Part Number	Nominal I.D.				Thread Size	A Overall Length		B Cutoff Allowance		R Diameter		Maximum Working Pressure	
	DN	Size	inch	mm		inch	mm	inch	mm	inch	mm	psi	bar
#													
1Y2UX-6-04C	6	-04	1/4	6.4	3/8" - 24 LH	4.29	109	2.20	56	0.71	18	20,000	1,380
1Y2UX-9-06C	10	-06	3/8	9.5	9/16"-18 LH	4.84	123	2.24	57	1.10	28	20,000	1,380



### WARNING

This product can expose you to chemicals including Lead, which is known to the State of California to cause cancer and birth defects or other reproductive harm. For more information go to [www.P65Warnings.ca.gov](http://www.P65Warnings.ca.gov).

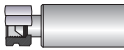



# WX Series Fittings

<b>WX Series Crimp Fittings</b>	<b>AY</b>	Type "M" Swivel - Female	<b>Y4</b>	High Pressure - Male	<b>YM</b>	Metric High Pressure - Male
						
	B-66		B-65		B-66	

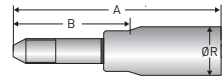
## 6Y4WX- High Pressure - Male

Material: Nipple - Stainless steel  
Shell - Stainless steel







Part Number	Nominal I.D.				Thread Size	A Overall Length		B Cutoff Allowance		R Diameter		Maximum Working Pressure*	
	DN	Size	inch	mm		inch	mm	inch	mm	inch	mm	psi	bar
<b>#</b>													
6Y4WX-16-8	25	-16	1	25.4	1"-14 LH	5.4	138	3.2	80	1.34	34	—	—

\* Fitting is rated to the full working pressure of the hose

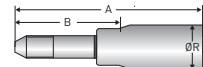
## 6Y4WX-x-55 - High Pressure - Male

Material: Nipple - Stainless steel  
Shell - Stainless steel



Part Number	Nominal I.D.				Thread Size	A Overall Length		B Cutoff Allowance		R Diameter		Maximum Working Pressure	
	DN	Size	inch	mm		inch	mm	inch	mm	inch	mm	psi	bar
<b>#</b>													
6Y4WX-9-5-55	8	-05	5/16	7.9	9/16"-18 LH	5.13	130	2.47	63	1.10	28	55,000	3,793



### WARNING

This product can expose you to chemicals including Lead, which is known to the State of California to cause cancer and birth defects or other reproductive harm. For more information go to [www.P65Warnings.ca.gov](http://www.P65Warnings.ca.gov).

Hose  
 A  
 Fittings  
 B  
 Adapters & Valves  
 C  
 Quick Couplings  
 D  
 Accessories  
 E  
 General Technical  
 F

# WX Series Fittings

## 6AYWX-x-55 - High Pressure - Male

Material: Nipple - Stainless steel

Shell - Stainless steel

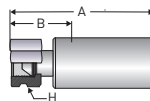

Part Number	Nominal I.D.				Thread Size	A Overall Length		B Cutoff Allowance		H Hex		Maximum Working Pressure	
	DN	Size	inch	mm		inch	mm	inch	mm	inch	mm	psi	bar
#													
6AYWX-10-5-55	8	-05	5/16	7.9	7/8" - 14	4.43	113	1.77	45	1.25	32	55,000	3,793

## 6YMWX - High Pressure Male Metric

Material: Nipple - Stainless steel

Shell - Stainless steel

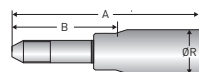

Part Number	Nominal I.D.				Thread Size	A Overall Length		B Cutoff Allowance		R Diameter		Maximum Working Pressure	
	DN	Size	inch	mm		inch	mm	inch	mm	inch	mm	psi	bar
#													
6YMWX-6-5-55	8	-05	5/16	7.9	M14x1.5-LH	4.72	120	2.20	56	.985	25	55,000	3,793
6YMWX-12-8*	12	-08	1/2	12.7	M20x1.5-LH	5.43	138	3.15	80	1.345	34	—	—

\* Fitting is rated to the full working pressure of the hose



### WARNING

This product can expose you to chemicals including Lead, which is known to the State of California to cause cancer and birth defects or other reproductive harm. For more information go to [www.P65Warnings.ca.gov](http://www.P65Warnings.ca.gov).

# Black Eagle Fittings

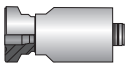
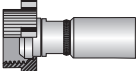
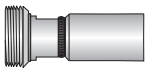
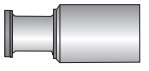
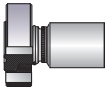
Black Eagle Crimp Fittings	<b>HB</b> Hub Flange	<b>HE</b> Hammer Union (Male) Cone w/ Wing Nut	<b>HN</b> Hammer Union (Female) Cone Threaded End w/ Seal	<b>6A</b> Code 62 Flange
	 B-68	 B-69, B-70	 B-71, B-72, B-73	 B-67
	<b>8K</b> API Hub w/ Flange			
	 B-68			

## 66A5X- Code 62 Flange

Material: Nipple - High strength stainless steel  
Shell - Stainless steel

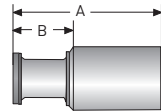

Part Number	Nominal I.D.				A Overall Length		B Cutoff Allowance		D Diameter		Maximum Working Pressure	
	DN	Size	inch	mm	inch	mm	inch	mm	inch	mm	psi	bar
<b>#</b>												
66A5X-32-32-TC3964	50	-32	2	50.8	9.75	248	4.39	111	3.13	79	5,000	340



### WARNING

This product can expose you to chemicals including Lead, which is known to the State of California to cause cancer and birth defects or other reproductive harm. For more information go to [www.P65Warnings.ca.gov](http://www.P65Warnings.ca.gov).

# Black Eagle Fittings

## 6HB5X- API Clamping Hub

Material: Nipple - High strength stainless steel  
Shell - Stainless steel

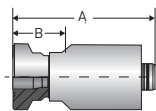

Part Number	Nominal I.D.				API Size	A Overall Length		B Cutoff Allowance		Seal		Maximum Working Pressure	
	DN	Size	inch	mm		inch	mm	inch	mm	inch	mm	psi	bar
#													
6HB5X-33-32-TC3964-5K	50	-32	2	50.8	2-1/16" 5,000 psi	10.18	259	4.68	119	—	BX152	5,000	340
6HB5X-33-32-TC3964-10K	50	-32	2	50.8	2-1/16" 10,000 psi	10.70	272	5.30	135	—	BX152	10,000	680
6HB5X-41-32-TC3964-5K	50	-32	2	50.8	2-9/16" 5,000 psi	10.18	259	4.68	119	—	BX153	5,000	340

## 68K5X- API Flange Hub

Material: Nipple - High strength stainless steel  
Shell - Stainless steel

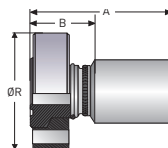

Part Number	Nominal I.D.				API Size	A Overall Length		B Cutoff Allowance		Seal		Maximum Working Pressure	
	DN	Size	inch	mm		inch	mm	inch	mm	inch	mm	psi	bar
#													
68K5X-33-32-17DSV3964-5K	50	-32	2	50.8	2-1/16" 5,000 psi	10.18	259	4.68	119	8.50	BX152	5,000	340
68K5X-33-32-17DSV3964-10K	50	-32	2	50.8	2-1/16" 10,000 psi	10.70	272	5.30	135	7.88	BX152	10,000	680
68K5X-41-32-17DSV3964-5K	50	-32	2	50.8	2-9/16" 5,000 psi	10.18	259	4.68	119	9.62	BX153	5,000	340



**WARNING**

This product can expose you to chemicals including Lead, which is known to the State of California to cause cancer and birth defects or other reproductive harm. For more information go to [www.P65Warnings.ca.gov](http://www.P65Warnings.ca.gov).



## 6HE5X- Hammer Union (Male) Cone w/ Wing Nut

Material: Nipple - Carbon steel, zinc-plated  
Shell - Stainless steel  
Nut - Carbon steel

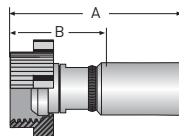

Part Number	Nominal I.D.				Thread Size	A Overall Length		B Cutoff Allowance		Maximum Working Pressure*	
	DN	Size	inch	mm		inch	mm	inch	mm	psi	bar
#											
6HE5X-32-32-FLATTC	50	-32	2	50.8	4-1/8"-3 ACME	11.50	292	6.10	155	—	—
6HE5X-32-32-SEGTC	50	-32	2	50.8	4-1/8"-3 ACME	11.73	298	6.34	161	—	—

\* Fitting is rated to the full working pressure of the hose

## 1HE5X- Hammer Union (Male) Cone w/ Wing Nut

Material: Nipple - High strength steel  
Shell - High strength stainless steel  
Nut - Carbon steel

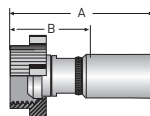

Part Number	Nominal I.D.				Thread Size	A Overall Length		B Cutoff Allowance		Maximum Working Pressure*	
	DN	Size	inch	mm		inch	mm	inch	mm	psi	bar
#											
1HE5X-32-24C4462-KOP2	50	-32	2	50.8	4-1/8"-3 ACME	9.13	232	4.25	108	15,000	1020
1HE5X-48-48	78	-48	3	76.0	4-1/8"-3 ACME	15.55	395	7.24	184	—	—
1HE5X-48-48-FLAT	78	-48	3	76.0	4-1/8"-3 ACME	15.55	395	7.22	183	—	—

\* Fitting is rated to the full working pressure of the hose



### WARNING

This product can expose you to chemicals including Lead, which is known to the State of California to cause cancer and birth defects or other reproductive harm. For more information go to [www.P65Warnings.ca.gov](http://www.P65Warnings.ca.gov).

# Black Eagle Fittings

## 1HECX- Hammer Union (Male) Cone w/ Wing Nut

Material: Nipple - High strength steel  
Shell - High strength stainless steel

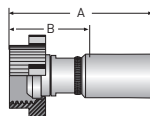

Part Number	Nominal I.D.				Thread Size	A Overall Length		B Cutoff Allowance		Maximum Working Pressure*	
	DN	Size	inch	mm		inch	mm	inch	mm	psi	bar
#											
1HECX-32-32-FLAT	50	-32	2	50.8	4-1/8" - 3 ACME	11.74	298	5.21	132	—	—

\* Fitting is rated to the full working pressure of the hose

## 1HELX- Hammer Union (Male) Cone w/ Wing Nut

Material: Nipple - High strength steel  
Shell - High strength stainless steel  
Nut - Carbon steel

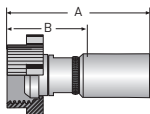

Part Number	Nominal I.D.				Thread Size	A Overall Length		B Cutoff Allowance		Maximum Working Pressure*	
	DN	Size	inch	mm		inch	mm	inch	mm	psi	bar
#											
1HELX-48-48	78	-48	3	76.0	5-3/8" - 3-1/2 ACME	15.55	395	7.52	191	—	—
1HELX-48-48-FLAT	78	-48	3	76.0	5-3/8" - 3-1/2 ACME	15.55	395	7.24	184	—	—

\* Fitting is rated to the full working pressure of the hose

## 1HES6- Hammer Union (Male) Cone w/ Wing Nut

Material: Nipple - High strength steel  
Shell - High strength stainless steel  
Nut - Carbon steel

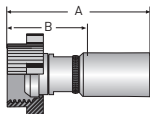

Part Number	Nominal I.D.				Thread Size	A Overall Length		B Cutoff Allowance		Maximum Working Pressure*	
	DN	Size	inch	mm		inch	mm	inch	mm	psi	bar
#											
1HES6-32-32-FLAT	50	-32	2	50.8	4-1/8" - 3 ACME	6.69	170	2.99	76	—	—
1HES6-32-32-FLAT-SC	50	-32	2	50.8	4-1/8" - 3 ACME	6.69	170	2.99	76	—	—

\* Fitting is rated to the full working pressure of the hose



### WARNING

This product can expose you to chemicals including Lead, which is known to the State of California to cause cancer and birth defects or other reproductive harm. For more information go to [www.P65Warnings.ca.gov](http://www.P65Warnings.ca.gov).

# Black Eagle Fittings

## 1HETX- Hammer Union (Male) Cone w/ Wing Nut

Material: Nipple - High strength steel  
 Shell - High strength stainless steel  
 Nut - Carbon steel

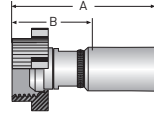

Part Number	Nominal I.D.				Thread Size	A Overall Length		B Cutoff Allowance		Maximum Working Pressure*	
	DN	Size	inch	mm		inch	mm	inch	mm	psi	bar
#											
1HETX-48-48	78	-48	3	76.0	5-3/8"-3 1/2 ACME	13.39	340	6.85	174	—	—
1HETX-48-48-FLAT	78	-48	3	76.0	5-3/8"-3 1/2 ACME	13.39	340	6.85	174	—	—

\* Fitting is rated to the full working pressure of the hose

## 6HN5X- Hammer Union (Female) Cone Threaded End w/ Seal

Material: Nipple - High strength steel  
 Shell - Stainless steel

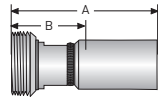

Part Number	Nominal I.D.				Thread Size	A Overall Length		B Cutoff Allowance		Maximum Working Pressure*	
	DN	Size	inch	mm		inch	mm	inch	mm	psi	bar
#											
6HN5X-32-32-TC	50	-32	2	50.8	4-1/8" - 3 ACME	9.56	243	4.18	106	—	—

\* Fitting is rated to the full working pressure of the hose



### WARNING

This product can expose you to chemicals including Lead, which is known to the State of California to cause cancer and birth defects or other reproductive harm. For more information go to [www.P65Warnings.ca.gov](http://www.P65Warnings.ca.gov).

# Black Eagle Fittings

## 1HN5X- Hammer Union (Female) Cone Threaded End w/ Seal

Material: Nipple - High strength steel  
Shell - High strength stainless steel

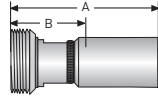

Part Number	Nominal I.D.				Thread Size	A Overall Length		B Cutoff Allowance		Maximum Working Pressure*	
	DN	Size	inch	mm		inch	mm	inch	mm	psi	bar
#											
1HN5X-32-24C4462-KOP2	40	-24	1-1/2	38.1	4-1/8" - 3 ACME	9.65	245	4.25	108	—	—
1HN5X-48-48	78	-48	3	76.0	5-3/8" - 3-1/2 ACME	15.95	405	7.64	194	—	—

\* Fitting is rated to the full working pressure of the hose

## 1HNLX- Hammer Union (Female) Cone Threaded End w/ Seal

Material: Nipple - High strength steel  
Shell - High strength stainless steel

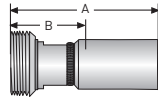

Part Number	Nominal I.D.				Thread Size	A Overall Length		B Cutoff Allowance		Maximum Working Pressure*	
	DN	Size	inch	mm		inch	mm	inch	mm	psi	bar
#											
1HNLX-48-48	78	-48	3	76.0	5-3/8" - 3-1/2 ACME	15.95	405	7.64	194	—	—

\* Fitting is rated to the full working pressure of the hose

## 1HNS6- Hammer Union (Female) Cone Threaded End w/ Seal

Material: Nipple - High strength steel  
Shell - High strength stainless steel

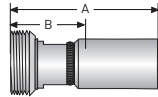

Part Number	Nominal I.D.				Thread Size	A Overall Length		B Cutoff Allowance		Maximum Working Pressure*	
	DN	Size	inch	mm		inch	mm	inch	mm	psi	bar
#											
1HNS6-32-32	50	-32	2	50.8	4-1/8" - 3 ACME	6.69	170	2.99	76	—	—
1HNS6-32-32-SC	50	-32	2	50.8	4-1/8" - 3 ACME	6.69	170	2.99	76	—	—

\* Fitting is rated to the full working pressure of the hose



**WARNING**

This product can expose you to chemicals including Lead, which is known to the State of California to cause cancer and birth defects or other reproductive harm. For more information go to [www.P65Warnings.ca.gov](http://www.P65Warnings.ca.gov).

# Black Eagle Fittings

## 1HNTX- Hammer Union (Female) Cone Threaded End w/ Seal

Material: Nipple - High strength steel  
Shell - High strength stainless steel

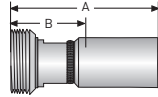

Part Number	Nominal I.D.				Thread Size	A Overall Length		B Cutoff Allowance		Maximum Working Pressure*	
	DN	Size	inch	mm		inch	mm	inch	mm	psi	bar
#											
1HNTX-48-48	78	-48	3	76.0	5-3/8" - 3 1/2 ACME	13.78	350	7.24	184	—	—

\* Fitting is rated to the full working pressure of the hose

## 1HNCX- Hammer Union (Female) Cone Threaded End w/ Seal

Material: Nipple - High strength steel  
Shell - High strength stainless steel

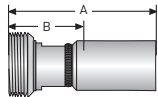

Part Number	Nominal I.D.				Thread Size	A Overall Length		B Cutoff Allowance		Maximum Working Pressure*	
	DN	Size	inch	mm		inch	mm	inch	mm	psi	bar
#											
1HNCX-32-32	50	-32	2	50.8	4-1/8" - 3 ACME	11.2	284	4.65	118	—	—

\* Fitting is rated to the full working pressure of the hose



### WARNING

This product can expose you to chemicals including Lead, which is known to the State of California to cause cancer and birth defects or other reproductive harm. For more information go to [www.P65Warnings.ca.gov](http://www.P65Warnings.ca.gov).

# Polyflex-Lok

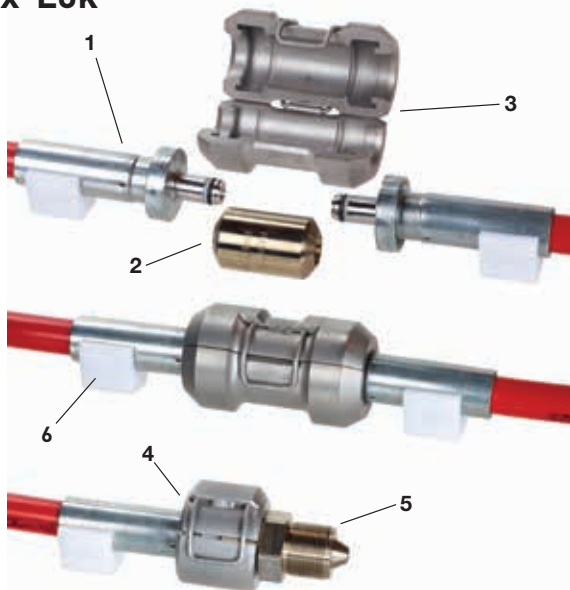

Ref	Part Number	Description
1	1TM2X-8-03-HPK	Fitting for DN 5 hoses including caps
	1TM2X-8-05-HPK	Fitting for DN 8 hoses including caps
	1TMKY-8-05-HPK	Fitting for DN 8 hoses including caps
	1TMBL-9-08-HPK	Fitting for DN 12 hoses including caps
	1TMBS-9-08-HPK	Fitting for DN 12 hoses including caps
2	TFTF-8-8	Hose connector bushing for DN 5 and DN 8
	TFTF-8-9	Hose connector bushing - connection DN 5 or DN 8 to DN 12
	TFTF-9-9	Hose connector bushing for DN 12
3	HPK-HS-8	Hose connector
4	HPK-HSP-8	Pump/gun connector
5	Y6TF-6-8	Adapter 3/4 - 16UNF to DN 5 or DN 8
	Y6TF-9-8	Adapter 1-1/8 - 12UNF to DN 5 or DN 8
6	TMCAP-8	Cap DN 5 or DN 8
	TMCAP-9	Cap DN 12

### Polyflex-Lok Pressure Rating for Size -03 / DN5: 46,400 psi

Size	DN	Hose Types
-03	DN5	2640D-03Vxx 2740D-03Vxx 2740D-03Vxx/xx

### Polyflex-Lok Pressure Rating for Size -05 / DN8: 46,400 psi

Size	DN	Hose Types
-05	DN8	2380N-05VxxW 2640D-05Vxx 2740D-05Vxx 2740D-05Vxx/xx 2748D-05Vxx 2748D-05Vxx/xx 2840D-05Vxx/xx

### Polyflex-Lok Pressure Rating for Size -08 / DN12: 36,250 psi

Size	DN	Hose Types
-08	DN12	2388N-08Vxx 2580N-08Vxx 2840D-08Vxx



#### WARNING

This product can expose you to chemicals including Lead, which is known to the State of California to cause cancer and birth defects or other reproductive harm. For more information go to [www.P65Warnings.ca.gov](http://www.P65Warnings.ca.gov).



# Adapters & Valves

Type "M" Adapters  
Medium Pressure  
Adapters  
High Pressure Adapters  
NPT Adapters  
JIC Adapters  
Medium Pressure Valves  
High Pressure Valves



# Table of Contents

## Introduction

Adapter Nomenclature.....	C-4
---------------------------	-----

## Adapters

<b>Type M</b> .....	<b>C-7</b>
YAYA .....	C-8
YAY6.....	C-8
YAY5.....	C-9
YAD9 .....	C-9
Plugs, Caps and Torpedos .....	C-10
<b>20,000 psi – Medium Pressure</b> .....	<b>C-11</b>
5YY5 .....	C-12
Y5Y5 .....	C-13
6YY5 .....	C-14
5YY6 .....	C-15
Y5Y6 .....	C-16
Y5D9 .....	C-16
5Y5Y .....	C-17
5Y6Y .....	C-18
L5Y .....	C-18
T5Y .....	C-19
X5Y .....	C-19
Y2N .....	C-19
Y2C .....	C-20
Plugs .....	C-20
Caps.....	C-20
Nipples.....	C-20
<b>30,000/60,000 psi – High Pressure</b> .....	<b>C-21</b>
6YY6.....	C-21
Y6Y6.....	C-22
X6Y6.....	C-22
6Y6Y.....	C-22
Y6D9 .....	C-23
L6Y .....	C-23
T6Y.....	C-23
X6Y .....	C-24
Y4N .....	C-24
Y4C .....	C-24
Plugs .....	C-24
Caps.....	C-25
Locking Anti-Vibration Nut and Collar .....	C-25
Nipples.....	C-25
<b>NPT</b> .....	<b>C-26</b>
K0101.....	C-27
K0201.....	C-28
K0202.....	C-29



# Table of Contents

Hose  
A

## Adapters (Continued)

### NPT (continued)

YA02.....	C-29
YA01.....	C-30
5Y01.....	C-31
02Y5.....	C-32
Y501.....	C-33
5Y02.....	C-34
6Y02.....	C-35
6Y01.....	C-36
Y601.....	C-37
02Y6.....	C-38
K0203.....	C-39
01D9.....	C-39
02D9.....	C-40
KL02.....	C-40
KT02.....	C-41
KX02.....	C-41
Caps.....	C-42
Plugs.....	C-42

### JIC..... C-43

K0303.....	C-44
K0306.....	C-44
K0606.....	C-44
YA03.....	C-45
Y503.....	C-45
Y603.....	C-46
Caps.....	C-46
Plugs.....	C-46

## Valves

### 20,000 psi — Medium Pressure..... C-47

AV5Y.....	C-48
SV5Y.....	C-48
TV25Y.....	C-49
TV15Y.....	C-49
CV5Y.....	C-49

### 30,000/60,000 psi — High Pressure..... C-50

SV6Y.....	C-50
AV6Y.....	C-50
TV26Y.....	C-51
TV16Y.....	C-51
CV6Y.....	C-52

DISCONTINUED

Fittings  
B

Adapters & Valves  
C

Quick Couplings  
D

Accessories  
E

General Technical  
F

# Adapter Nomenclature

## Adapter Part Numbers

Most adapter part number structures will follow the below examples.

### Example: YA01-11-8C

**YA**01-11-8C – **Connection Type #1** (YA = Male Type M)  
**YA****01**-11-8C – **Connection Type #2** (01 = Male NPT)  
**YA**01-**11**-8C – **Connection Size #1** (11 = 1"-12 thread size for the Type M connection)  
**YA**01-11-**8C** – **Connection Size #2** (8 = 1/2"-14 thread size for the NPT connection)  
**YA**01-11-8**C** – **Material** (316 Stainless Steel)

### Example: 15K0101-4-4C

**15K**0101-4-4C – **Pressure Rating** (15K = 15,000 psi)  
**15K****01**01-4-4C – **Connection Type #1** (01 = Male NPT)  
**15K**01**01**-4-4C – **Connection Type #2** (01 = Male NPT)  
**15K**0101-**4**-4C – **Connection Size #1** (4 = 1/4" -18)  
**15K**0101-4-**4C** – **Connection Size #2** (4 = 1/4" -18)  
**15K**0101-4-4**C** – **Material** (316 Stainless Steel)

Connection Type Designations-The choice of connection type may limit the working pressure of the adapter (i.e., a High Pressure to Type M adapter will be limited to Type M pressures).					
YA	Male, Type M	Y6	Male, High Pressure	03	Male JIC
Y5	Male, Medium Pressure	6Y	Female, High Pressure	X6	Low Angle Face Seal
5Y	Female, Medium Pressure	Y4	Male, High Pressure, Tube Type	D9	Male BSP
Y2	Male, Medium Pressure, Torpedo Type	01 02	Male NPT Pipe Female NPT Pipe		

Connection Tube / Thread Size							
NPT Connections		JIC Connections		Type "M" Connections		BSP Connections	
-01	1/16"-27	-04	7/16"-20 UNF	-06	9/16"-18 UNF	-02	G 1/8"
-02	1/8"-27	-06	9/16"-18 UNF	-08	3/4"-16 UNF	-04	G 1/4"
-04	1/4"-18	-08	3/4"-16 UNF	-10	7/8"-14 UNF	-06	G 3/8"
-06	3/8"-18	-10	7/8"-14 UNF	-12	1"-12 UNF	-08	G 1/2"
-08	1/2"-14	-12	1-1/16"-12 UN	-16	1-5/16"-12 UN		
-12	3/4"-16	-16	1-5/16"-12 UN				
-16	1"-11-1/2						

Medium and High Pressure Port Sizes				
-04	-06	-09	-12	-16
1/4"	3/8	9/16	3/4	1
Medium Pressure				
7/16"-20 UNF	9/16"-18 UNF	13/16"-16 UN	3/4"-14 NPS	1-3/8"-12 UNF
High Pressure				
9/16"-18 UNF	3/4"-16 UNF	1-1/8"-12 UNF		

# Adapter Nomenclature

Hose  
A

## Connection Accessory Part Numbers — Crosses, Elbows and Tees

Connection accessories include crosses, elbows and tees. Part numbers for these accessories will always begin with a one-letter code (X, L or T) designating the accessory type, followed by a two-digit code representing the connection type. The connection size and material make up the end of the part number.

### Example: L-6Y-9C

**L-6Y-9C** – **Accessory Type** (L = Elbow)  
**L-6Y-9C** – **Connection Type** (6Y = Female high pressure connection)  
**L-6Y-9C** – **Connection Size** (9 = 1-1/8"-12 UNF thread size)  
**L-6Y-9C** – **Material** (316 Stainless Steel)

Fittings  
B

Accessory Type	
X	Code given for Crosses
L	Code given for Elbows
T	Code given for Tees

Connection Type	
02	Female NPT
5Y	Female Medium Pressure
6Y	Female High Pressure

NPT - Connection Tube / Thread Size						
-01	-02	-04	-06	-08	-12	-16
1/8"	1/8"	1/4"	3/8	1/2	3/4	1
1/16"-27	1/8"-27	1/4"-18	3/8"-18	1/2"-14	3/4"-14	1"-11-1/2

Medium & High Pressure - Connection Tube / Thread Size				
-04	-06	-09	-12	-16
1/4"	3/8	9/16	3/4	1
Medium Pressure				
7/16"-20 UNF	9/16"-18 UNF	13/16"-16 UN	3/4"-14 NPS	1-3/8"-12 UNF
High Pressure				
9/16"-18 UNF	3/4"-16 UNF	1-1/8"-12 UNF		

Adapters & Valves  
C

Quick Couplings  
D

Accessories  
E

General Technical  
F

# Adapter Nomenclature

## Connection Accessory Part Numbers — Gland Nuts and Collars

Gland nuts and collars are simple in their make-up. Unlike crosses, elbows and tees, the gland nut and collar part numbers begin with the connection type followed by a one-letter code identifying the part as a gland nut or collar. The connection size and material codes make up the end of the part number.

### Example: Y4N-6C

**Y4N-6C** – **Connection Type** (Y4 = High Pressure)

**Y4N-6C** – **Accessory Type** (N = Gland Nut)

**Y4N-6C** – **Connection Size** (06 = 3/8")

**Y4N-6C** – **Material** (316 Stainless Steel)

Connection Type		Accessory Type	
Y2	Medium Pressure Connection	N	Gland Nuts
Y4	High Pressure Connection	C	Collars

Medium and High Pressure Port Sizes				
-04	-06	-09	-12	-16
1/4"	3/8	9/16	3/4	1
Medium Pressure				
7/16"-20 UNF	9/16"-18 UNF	13/16"-16 UN	3/4"-14 NPS	1-3/8"-12 UNF
High Pressure				
9/16"-18 UNF	3/4"-16 UNF	1-1/8"-12 UNF		

## Connection Accessory Part Numbers — Threaded Tube Nipples

### Example: Y406-0800C

**Y406-0800C** – **Connection Type** (Y4 = High Pressure)

**Y406-0800C** – **Tube Size** (06 = 3/8")

**Y406-0800C** – **Tube Length** (0800 = 8" length)

**Y406-0800C** – **Material** (316 Stainless Steel)

Connection Type	
Y2	Medium Pressure
Y4	High Pressure

Tube Size	
04	1/4"
06	3/8"
09	9/16"

Tube Length	
0300	3" in length
0400	4" in length
0600	6" in length
0800	8" in length
1000	10" in length
Length = distance between tips of each cone	

# Type "M" Adapters



The Type "M" adapters have a 60° female cone. Each Type "M" adapter is **rated for the full working pressure of the hose.**

## Thread Sizes:

- 06 9/16"-18 UNF
- 08 3/4"-16 UNF
- 10 7/8"-14 UNF
- 11 1"-12 UNF
- 16 1-5/16"-12 UN



### WARNING

This product can expose you to chemicals including Lead, which is known to the State of California to cause cancer and birth defects or other reproductive harm. For more information go to [www.P65Warnings.ca.gov](http://www.P65Warnings.ca.gov).

## Type "M" Adapters

### YAYA — Male Type "M" x Male Type "M"

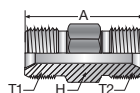

Part Number	T1 Thread Size	T2 Thread Size	A Overall Length		H Hex		Maximum Working Pressure	
			inch	mm	inch	mm	psi	bar
#								
YAYA-6-6C	9/16"-18 UNF	9/16"-18 UNF	1.38	35.05	0.63	16.00	60,000	4,140
YAYA-8-6C	3/4"-16 UNF	9/16"-18 UNF	1.63	41.40	0.75	19.05	30,000	2,070
YAYA-8-8C	3/4"-16 UNF	3/4"-16 UNF	1.75	44.45	0.75	19.05	30,000	2,070
YAYA-10-6C	7/8"-14 UNF	9/16"-18 UNF	1.88	47.75	1.00	25.40	60,000	4,140
YAYA-10-10C	7/8"-14 UNF	7/8"-14 UNF	2.00	50.80	1.00	25.40	50,000	3,445
YAYA-11-8C	1"-12 UNF	3/4"-16 UNF	1.88	47.75	1.00	25.40	30,000	2,070
YAYA-11-10C	1"-12 UNF	7/8" 14 UNF	1.98	50.29	1.00	25.40	30,000	2,070
YAYA-11-11C	1"-12 UNF	1"-12 UNF	1.88	47.75	1.00	25.40	30,000	2,070
YAYA-16-11C	1-5/16"-12 UN	1"-12 UNF	2.13	54.10	1.38	35.05	20,000	1,380
YAYA-16-16C	1-5/16"-12 UN	1-5/16"-12 UN	2.13	54.10	1.38	35.05	20,000	1,380

### YAY6 — Male Type "M" x Male High Pressure

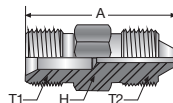

Part Number	T1 Thread Size	T2 Thread Size	Nominal Tube Size	A Overall Length		H Hex		Maximum Working Pressure	
				inch	mm	inch	mm	psi	bar
#									
YAY6-6-4C	9/16"-18 UNF	9/16"-18 UNF	1/4" HP	1.55	39.37	0.75	19.05	60,000	4,140
YAY6-6-6C	9/16"-18 UNF	3/4"-16 UNF	3/8" HP	1.75	44.45	0.75	19.05	60,000	4,140
YAY6-6-9C	9/16"-18 UNF	1-1/8"-12 UNF	9/16" HP	2.00	50.80	1.13	28.70	60,000	4,140
YAY6-8-6C	3/4"-16 UNF	3/4"-16 UNF	3/8" HP	2.00	50.80	0.75	19.05	30,000	2,070
YAY6-8-9C	3/4"-16 UNF	1-1/8"-12 UNF	9/16" HP	2.25	57.15	1.13	28.70	30,000	2,070
YAY6-10-6C	7/8"-14 UNF	3/4"-16 UNF	3/8" HP	2.25	57.15	1.00	25.40	60,000	4,140
YAY6-10-9C	7/8"-14 UNF	1-1/8"-12 UNF	9/16" HP	2.38	60.45	1.13	28.70	60,000	4,140
YAY6-11-9C	1"-12 UNF	1-1/8"-12 UNF	9/16" HP	2.25	57.15	1.13	28.70	30,000	2,070



#### WARNING

This product can expose you to chemicals including Lead, which is known to the State of California to cause cancer and birth defects or other reproductive harm. For more information go to [www.P65Warnings.ca.gov](http://www.P65Warnings.ca.gov).

# Type "M" Adapters

## YAY5 — Male Type "M" x Male Medium Pressure

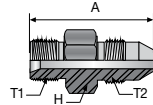

Part Number	T1 Thread Size	T2 Thread Size	Nominal Tube Size	A Overall Length		H Hex		Maximum Working Pressure	
				inch	mm	inch	mm	psi	bar
#									
YAY5-6-4C	9/16"-18 UNF	7/16"-20 UNF	1/4" MP	1.56	39.62	0.63	16.00	20,000	1,380
YAY5-6-6C	9/16"-18 UNF	9/16"-18 UNF	3/8" MP	1.63	41.40	0.63	16.00	20,000	1,380
YAY5-6-9C	9/16"-18 UNF	13/16"-16 UN	9/16" MP	2.00	50.80	0.88	22.35	20,000	1,380
YAY5-6-12C	9/16"-18 UNF	3/4"-14 NPS	3/4" MP	2.32	58.93	1.13	28.70	20,000	1,380
YAY5-8-4C	3/4"-16 UNF	7/16"-20 UNF	1/4" MP	1.68	42.67	0.75	19.05	20,000	1,380
YAY5-8-6C	3/4"-16 UNF	9/16"-18 UNF	3/8" MP	1.88	47.75	0.75	19.05	20,000	1,380
YAY5-8-9C	3/4"-16 UNF	13/16"-16 UN	9/16" MP	2.20	55.88	0.88	22.35	20,000	1,380
YAY5-8-12C	3/4"-16 UNF	3/4"-14 NPS	3/4" MP	2.44	61.98	1.13	28.70	20,000	1,380
YAY5-11-4C	1"-12 UNF	7/16"-20 UNF	1/4" MP	1.94	49.28	1.00	25.40	20,000	1,380
YAY5-11-6C	1"-12 UNF	9/16"-18 UNF	3/8" MP	2.00	50.80	1.00	25.40	20,000	1,380
YAY5-11-9C	1"-12 UNF	13/16"-16 UN	9/16" MP	2.25	57.15	1.00	25.40	20,000	1,380
YAY5-11-12C	1"-12 UNF	3/4"-14 NPS	3/4" MP	2.44	61.98	1.13	28.70	20,000	1,380
YAY5-16-9C	1-5/16"-12 UN	13/16"-16 UN	9/16" MP	2.50	63.50	1.38	35.05	20,000	1,380
YAY5-16-12C	1-5/16"-12 UN	3/4"-14 NPS	3/4" MP	2.70	68.58	1.38	35.05	20,000	1,380

## YAD9 — Male Type "M" x Male BSP

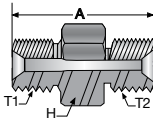

Part Number	T1 Thread Size	T2 Thread Size	A Overall Length		H Hex		Maximum Working Pressure	
			inch	mm	inch	mm	psi	bar
#								
YAD9-6-4C	9/16"-18 UNF	G 1/4"-19	1.36	34.54	0.75	19.05	30,000	2,070
YAD9-6-6C*	9/16"-18 UNF	G 3/8"-19	1.36	34.54	0.875	22.23	30,000	2,070
YAD9-6-8C*	9/16"-18 UNF	G 1/2"-14	1.54	39.12	1.00	25.40	30,000	2,070

\*Non-standard part - may require longer lead time





### WARNING

This product can expose you to chemicals including Lead, which is known to the State of California to cause cancer and birth defects or other reproductive harm. For more information go to [www.P65Warnings.ca.gov](http://www.P65Warnings.ca.gov).

Hose  
A  
Fittings  
B  
Adapters & Valves  
C  
Quick Couplings  
D  
Accessories  
E  
General Technical  
F



# Type "M" Adapters

## Plugs

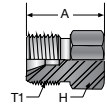
Part Number	T1 Thread Size	A Overall Length		H Hex		Maximum Working Pressure	
		inch	mm	inch	mm	psi	bar
#							
YA6C-PLUG	9/16"-18 UNF	2.07	52.58	0.75	19.05	60,000	4,140
YA8C-PLUG	3/4"-16 UNF	2.13	54.10	1.00	25.40	30,000	2,070
YA11C-PLUG	1"-12 UNF	1.25	31.75	1.00	25.40	30,000	2,070
YA16C-PLUG	1-5/16"-12 UN	2.63	66.80	1.38	35.05	20,000	1,380





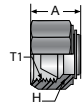

## Caps

Part Number	T1 Thread Size	A Overall Length		H Hex		Maximum Working Pressure	
		inch	mm	inch	mm	psi	bar
#							
AY6C-CAP	9/16"-18 UNF	0.85	21.59	0.69	17.53	60,000	4,140
AY8C-CAP	3/4"-16 UNF	0.91	23.11	1.00	25.40	30,000	2,070
AY11C-CAP	1"-12 UNF	1.31	33.27	1.25	31.75	30,000	2,070
AY16C-CAP	1-5/16"-12 UN	1.20	30.48	1.50	38.10	20,000	1,380



## Torpedos

Part Number	T1 Thread Size	T2 Thread Size	A Overall Length		H Hex		Maximum Working Pressure	
			inch	mm	inch	mm	psi	bar
#								
YAY1-8-16C	3/4"-16 UNF	1"-14 LH	3.56	90.42	1.13	28.70	20,000	1,380
YAY2-8-16C	3/4"-16 UNF	1"-14 LH	3.56	90.42	1.38	35.05	20,000	1,380
YAY1-11-16C	1"-12 UNF	1"-14 LH	3.56	90.42	1.13	28.70	20,000	1,380
YAY2-11-16C	1"-12 UNF	1"-14 LH	3.56	90.42	1.38	35.05	20,000	1,380
YAY1-16-16C	1-5/16"-12 UN	1"-14 LH	3.70	93.98	1.38	35.05	20,000	1,380
YAY2-16-16C	1-5/16"-12 UN	1"-14 LH	3.70	93.98	1.38	35.05	20,000	1,380

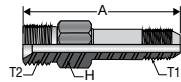

### WARNING

This product can expose you to chemicals including Lead, which is known to the State of California to cause cancer and birth defects or other reproductive harm. For more information go to [www.P65Warnings.ca.gov](http://www.P65Warnings.ca.gov).



# Medium Pressure Adapters



Medium Pressure is a 58/60 degree coned and threaded tubing design. They have a **maximum working pressure rating of 20,000 psi.**

## Advantages:

- An industry standard for use at elevated pressures
- Large orifice allows maximum flow of liquids and gases
- Suitable for repetitive assembly and disassembly

## Thread Sizes - determined by tube OD:

- 04 1/4" O.D. x 0.109" I.D. — 7/16"-20 male thread on gland nut
- 06 3/8" O.D. x 0.19" I.D. — 9/16"-18 male thread on gland nut
- 09 9/16" O.D. x 0.31" I.D. — 13/16"-16 male thread on gland nut
- 12 3/4" O.D. x 0.44" I.D. — 3/4"-National Pipe Straight male on gland nut
- 16 1" O.D. x 0.56" I.D. — 1-3/8"-12 male thread on gland nut



## WARNING

This product can expose you to chemicals including Lead, which is known to the State of California to cause cancer and birth defects or other reproductive harm. For more information go to [www.P65Warnings.ca.gov](http://www.P65Warnings.ca.gov).

# Medium Pressure Adapters

## 5YY5 — Female Medium Pressure x Male Medium Pressure

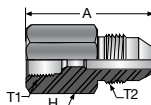

Part Number	T1 Thread Size	T2 Thread Size	A Overall Length		H Hex		Maximum Working Pressure	
			inch	mm	inch	mm	psi	bar
#								
5YY5-4-6C	7/16"-20 UNF	9/16"-18 UNF	1.75	44.45	0.75	19.05	20,000	1,380
5YY5-4-9C	7/16"-20 UNF	13/16"-16 UN	1.87	47.50	0.87	22.10	20,000	1,380
5YY5-4-12C	7/16"-20 UNF	3/4"-14 NPS	2.00	50.80	1.12	28.45	20,000	1,380
5YY5-4-16C	7/16"-20 UNF	1-3/8"-12 UNF	3.00	76.20	1.00	25.40	20,000	1,380
5YY5-6-4C	9/16"-18 UNF	7/16"-20 UNF	1.75	44.45	0.75	19.05	20,000	1,380
5YY5-6-9C	9/16"-18 UNF	13/16"-16 UN	1.87	47.50	0.87	22.10	20,000	1,380
5YY5-6-12C	9/16"-18 UNF	3/4"-14 NPS	2.00	50.80	1.12	28.45	20,000	1,380
5YY5-6-16C*	9/16"-18 UNF	1-3/8"-12 UNF	3.12	79.25	1.00	25.40	20,000	1,380
5YY5-9-4C	13/16"-16 UN	7/16"-20 UNF	2.12	53.85	1.00	25.40	20,000	1,380
5YY5-9-6C	13/16"-16 UN	9/16"-18 UNF	2.12	53.85	1.00	25.40	20,000	1,380
5YY5-9-12C	13/16"-16 UN	3/4"-14 NPS	2.50	63.50	1.12	28.45	20,000	1,380
5YY5-9-16C	13/16"-16 UN	1-3/8"-12 UNF	3.37	85.60	1.00	25.40	20,000	1,380
5YY5-12-4C*	3/4"-14 NPS	7/16"-20 UNF	1.25	31.75	1.37	34.80	20,000	1,380
5YY5-12-6C	3/4"-14 NPS	9/16"-18 UNF	2.37	60.20	1.37	34.80	20,000	1,380
5YY5-12-9C	3/4"-14 NPS	13/16"-16 UN	2.87	72.90	1.37	34.80	20,000	1,380
5YY5-12-16C	3/4"-14 NPS	1-3/8"-12 UNF	3.75	95.25	1.37	34.80	20,000	1,380
5YY5-16-4C	1-3/8"-12 UNF	7/16"-20 UNF	2.75	69.85	1.75	44.45	20,000	1,380
5YY5-16-6C	1-3/8"-12 UNF	9/16"-18 UNF	2.87	72.90	1.75	44.45	20,000	1,380
5YY5-16-9C	1-3/8"-12 UNF	13/16"-16 UN	3.00	76.20	1.75	44.45	20,000	1,380
5YY5-16-12C	1-3/8"-12 UNF	3/4"-14 NPS	3.25	82.55	1.75	44.45	20,000	1,380

\*Non-standard part - may require longer lead time



### WARNING

This product can expose you to chemicals including Lead, which is known to the State of California to cause cancer and birth defects or other reproductive harm. For more information go to [www.P65Warnings.ca.gov](http://www.P65Warnings.ca.gov).

# Medium Pressure Adapters

## Y5Y5 — Male Medium Pressure x Male Medium Pressure

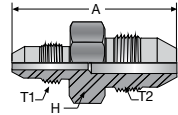

Part Number #	T1 Thread Size	T2 Thread Size	A Overall Length		H Hex		Maximum Working Pressure	
			inch	mm	inch	mm	psi	bar
Y5Y5-4-4C	7/16"-20 UNF	7/16"-20 UNF	2.00	50.80	0.62	15.75	20,000	1,380
Y5Y5-4-6C	7/16"-20 UNF	9/16"-18 UNF	2.12	53.85	0.75	19.05	20,000	1,380
Y5Y5-4-9C	7/16"-20 UNF	13/16"-16 UN	2.18	55.37	0.875	22.23	20,000	1,380
Y5Y5-4-12C	7/16"-20 UNF	3/4"-14 NPS	2.50	63.50	1.12	28.45	20,000	1,380
Y5Y5-4-16C	7/16"-20 UNF	1-3/8"-12 UNF	3.62	91.95	1.00	25.40	20,000	1,380
Y5Y5-6-6C	9/16"-18 UNF	9/16"-18 UNF	2.25	57.15	0.75	19.05	20,000	1,380
Y5Y5-6-9C	9/16"-18 UNF	13/16"-16 UN	2.50	63.50	0.875	22.10	20,000	1,380
Y5Y5-6-12C	9/16"-18 UNF	3/4"-14 NPS	2.62	66.55	1.12	28.45	20,000	1,380
Y5Y5-6-16C	9/16"-18 UNF	1-3/8"-12 UNF	3.75	95.25	1.00	25.40	20,000	1,380
Y5Y5-9-9C	13/16"-16 UN	13/16"-16 UN	2.50	63.50	1.00	25.40	20,000	1,380
Y5Y5-9-12C	13/16"-16 UN	3/4"-14 NPS	2.87	72.90	1.12	28.45	20,000	1,380
Y5Y5-9-16C	13/16"-16 UN	1-3/8"-12 UNF	4.00	101.60	1.00	25.40	20,000	1,380
Y5Y5-12-12C	3/4"-14 NPS	3/4"-14 NPS	3.00	76.20	1.12	28.45	20,000	1,380
Y5Y5-12-16C	3/4"-14 NPS	1-3/8"-12 UNF	1.25	31.75	1.12	28.45	20,000	1,380
Y5Y5-16-16C	1-3/8"-12 UNF	1-3/8"-12 UNF	4.25	107.95	1.375	34.93	20,000	1,380



### WARNING

This product can expose you to chemicals including Lead, which is known to the State of California to cause cancer and birth defects or other reproductive harm. For more information go to [www.P65Warnings.ca.gov](http://www.P65Warnings.ca.gov).

# Medium Pressure Adapters

## 6YY5 — Female High Pressure x Male Medium Pressure

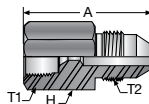

Part Number	T1 Thread Size	T2 Thread Size	A Overall Length		H Hex		Maximum Working Pressure	
			inch	mm	inch	mm	psi	bar
#								
6YY5-4-4C	9/16"-18 UNF	7/16"-20 UNF	1.75	44.45	0.75	19.05	20,000	1,380
6YY5-4-6C	9/16"-18 UNF	9/16"-18 UNF	1.75	44.45	0.75	19.05	20,000	1,380
6YY5-4-9C	9/16"-18 UNF	13/16"-16 UN	1.87	47.50	0.87	22.10	20,000	1,380
6YY5-4-12C*	9/16"-18 UNF	3/4"-14 NPS	2.25	57.15	1.12	28.45	20,000	1,380
6YY5-4-16C	9/16"-18 UNF	1-3/8"-12 UNF	3.00	76.20	1.00	25.40	20,000	1,380
6YY5-6-4C	3/4"-16 UNF	7/16"-20 UNF	1.87	47.50	1.00	25.40	20,000	1,380
6YY5-6-6C	3/4"-16 UNF	9/16"-18 UNF	1.87	47.50	1.00	25.40	20,000	1,380
6YY5-6-9C*	3/4"-16 UNF	13/16"-16 UN	2.00	50.80	1.00	25.40	20,000	1,380
6YY5-6-12C	3/4"-16 UNF	3/4"-14 NPS	2.25	57.15	1.12	28.45	20,000	1,380
6YY5-6-16C	3/4"-16 UNF	1-3/8"-12 UNF	3.25	82.55	1.00	25.40	20,000	1,380
6YY5-9-4C	1-1/8"-12 UNF	7/16"-20 UNF	2.12	53.85	1.37	34.80	20,000	1,380
6YY5-9-6C*	1-1/8"-12 UNF	9/16"-18 UNF	2.12	53.85	1.37	34.80	20,000	1,380
6YY5-9-9C	1-1/8"-12 UNF	13/16"-16 UN	2.37	60.20	1.37	34.80	20,000	1,380
6YY5-9-12C	1-1/8"-12 UNF	3/4"-14 NPS	2.50	63.50	1.37	34.80	20,000	1,380
6YY5-9-16C	1-1/8"-12 UNF	1-3/8"-12 UNF	3.62	91.95	1.37	34.80	20,000	1,380

\*Non-standard part - may require longer lead time



### WARNING

This product can expose you to chemicals including Lead, which is known to the State of California to cause cancer and birth defects or other reproductive harm.

For more information go to [www.P65Warnings.ca.gov](http://www.P65Warnings.ca.gov).

# Medium Pressure Adapters

## 5YY6 — Female Medium Pressure x Male High Pressure

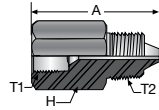

Part Number	T1 Thread Size	T2 Thread Size	A Overall Length		H Hex		Maximum Working Pressure	
			inch	mm	inch	mm	psi	bar
#								
5YY6-4-4C	7/16"-20 UNF	9/16"-18 UNF	1.37	34.80	0.75	19.05	20,000	1,380
5YY6-4-6C	7/16"-20 UNF	3/4"-16 UNF	1.75	44.45	0.75	19.05	20,000	1,380
5YY6-4-9C	7/16"-20 UNF	1-1/8"-12 UNF	2.12	53.85	1.12	28.45	20,000	1,380
5YY6-6-4C	9/16"-18 UNF	9/16"-18 UNF	1.75	44.45	0.75	19.05	20,000	1,380
5YY6-6-6C	9/16"-18 UNF	3/4"-16 UNF	1.75	44.45	0.75	19.05	20,000	1,380
5YY6-6-9C	9/16"-18 UNF	1-1/8"-12 UNF	2.12	53.85	1.12	28.45	20,000	1,380
5YY6-9-4C	13/16"-16 UN	9/16"-18 UNF	1.87	47.50	1.00	25.40	20,000	1,380
5YY6-9-6C	13/16"-16 UN	3/4"-16 UNF	2.12	53.85	1.00	25.40	20,000	1,380
5YY6-9-9C	13/16"-16 UN	1-1/8"-12 UNF	2.12	53.85	1.12	28.45	20,000	1,380
5YY6-12-4C	3/4"-14 NPS	9/16"-18 UNF	2.50	63.50	1.37	34.80	20,000	1,380
5YY6-12-6C	3/4"-14 NPS	3/4"-16 UNF	2.37	60.20	1.37	34.80	20,000	1,380
5YY6-12-9C	3/4"-14 NPS	1-1/8"-12 UNF	2.62	66.55	1.37	34.80	20,000	1,380
5YY6-16-4C*	1-3/8"-12 UNF	9/16"-18 UNF	2.62	66.55	1.75	44.45	20,000	1,380
5YY6-16-6C*	1-3/8"-12 UNF	3/4"-16 UNF	2.87	72.90	1.75	44.45	20,000	1,380
5YY6-16-9C	1-3/8"-12 UNF	1-1/8"-12 UNF	3.12	79.25	1.75	44.45	20,000	1,380

\*Non-standard part - may require longer lead time



### WARNING

This product can expose you to chemicals including Lead, which is known to the State of California to cause cancer and birth defects or other reproductive harm. For more information go to [www.P65Warnings.ca.gov](http://www.P65Warnings.ca.gov).

# Medium Pressure Adapters

## Y5Y6 — Male Medium Pressure x Male High Pressure

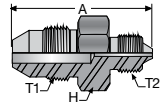

Part Number	T1 Thread Size	T2 Thread Size	A Overall Length		H Hex		Maximum Working Pressure	
			inch	mm	inch	mm	psi	bar
#								
Y5Y6-4-4C	7/16"-20 UNF	9/16"-18 UNF	1.73	43.94	0.63	16.00	20,000	1,380
Y5Y6-4-6C	7/16"-20 UNF	3/4"-16 UNF	2.10	53.34	0.75	19.05	20,000	1,380
Y5Y6-4-9C	7/16"-20 UNF	1-1/8"-12 UNF	2.37	60.20	1.12	28.45	20,000	1,380
Y5Y6-6-4C	9/16"-18 UNF	9/16"-18 UNF	2.12	53.85	0.62	15.75	20,000	1,380
Y5Y6-6-9C	9/16"-18 UNF	1-1/8"-12 UNF	2.50	63.50	1.12	28.45	20,000	1,380
Y5Y6-9-4C	13/16"-16 UN	9/16"-18 UNF	2.25	57.15	0.87	22.10	20,000	1,380
Y5Y6-9-6C	13/16"-16 UN	3/4"-16 UNF	2.38	60.45	0.875	22.23	20,000	1,380
Y5Y6-9-9C	13/16"-16 UN	1-1/8"-12 UNF	2.62	66.55	1.12	28.45	20,000	1,380
Y5Y6-12-4C	3/4"-14 NPS	9/16"-18 UNF	2.62	66.55	1.12	28.45	20,000	1,380
Y5Y5-12-6C*	3/4"-14 NPS	3/4"-16 UNF	2.75	69.85	1.12	28.45	20,000	1,380
Y5Y6-12-9C	3/4"-14 NPS	1-1/8"-12 UNF	3.00	76.20	1.12	28.45	20,000	1,380
Y5Y6-16-4C*	1-3/8"-12 UNF	9/16"-18 UNF	3.62	91.95	1.00	25.40	20,000	1,380
Y5Y6-16-6C*	1-3/8"-12 UNF	3/4"-16 UNF	4.00	101.60	1.00	25.40	20,000	1,380
Y5Y6-16-9C	1-3/8"-12 UNF	1-1/8"-12 UNF	4.00	101.60	1.12	28.45	20,000	1,380

\*Non-standard part - may require longer lead time

## Y5D9 — Male Medium Pressure x Male BSP

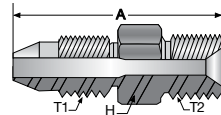

Part Number	T1 Thread Size	T2 Thread Size	A Overall Length		H Hex		Maximum Working Pressure	
			inch	mm	inch	mm	psi	bar
#								
Y5D9-4-4C	7/16"-20 UNF	G1/4-19	1.47	37.34	0.75	19.05	20,000	1,380
Y5D9-6-4C	9/16"-18 UNF	G1/4-19	1.69	42.93	0.75	19.05	20,000	1,380
Y5D9-6-6C	9/16"-18 UNF	G3/8-19	1.66	42.16	0.875	22.23	20,000	1,380
Y5D9-9-6C	13/16"-16 UN	G3/8-19	1.88	47.75	0.875	22.23	20,000	1,380



**WARNING**

This product can expose you to chemicals including Lead, which is known to the State of California to cause cancer and birth defects or other reproductive harm.

For more information go to [www.P65Warnings.ca.gov](http://www.P65Warnings.ca.gov).

# Medium Pressure Adapters

## 5Y5Y — Female / Female Medium Pressure, Straight Coupling

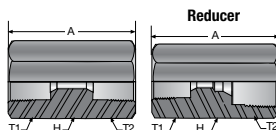

Part Number	T1 Thread Size	T2 Thread Size	A Overall Length		H Hex		Maximum Working Pressure	
			inch	mm	inch	mm	psi	bar
#								
5Y5Y-4-4C	7/16"-20 UNF	7/16"-20 UNF	1.62	41.15	0.75	19.05	20,000	1,380
5Y5Y-6-6C	9/16"-18 UNF	9/16"-18 UNF	1.75	44.45	0.75	19.05	20,000	1,380
5Y5Y-9-9C	13/16"-16 UN	13/16"-16 UN	2.12	53.85	1.00	25.40	20,000	1,380
5Y5Y-12-12C	3/4"-14 NPS	3/4"-14 NPS	2.50	63.50	1.37	34.80	20,000	1,380
5Y5Y-16-16C	1-3/8"-12 UNF	1-3/8"-12 UNF	3.50	88.90	1.75	44.45	20,000	1,380

## Reducer Coupling

			inch	mm	inch	mm	psi	bar
5Y5Y-4-6C	7/16"-20 UNF	9/16"-18 UNF	1.75	44.45	0.75	19.05	20,000	1,380
5Y5Y-4-9C	7/16"-20 UNF	13/16"-16 UN	2.12	53.85	1.00	25.40	20,000	1,380
5Y5Y-4-12C*	7/16"-20 UNF	3/4"-14 NPS	2.50	63.50	1.37	34.80	20,000	1,380
5Y5Y-4-16C	7/16"-20 UNF	1-3/8"-12 UNF	3.50	88.90	1.75	44.45	20,000	1,380
5Y5Y-6-9C	9/16"-18 UNF	13/16"-16 UN	2.12	53.85	1.00	25.40	20,000	1,380
5Y5Y-6-12C	9/16"-18 UNF	3/4"-14 NPS	2.50	63.50	1.37	34.80	20,000	1,380
5Y5Y-6-16C	9/16"-18 UNF	1-3/8"-12 UNF	3.50	88.90	1.75	44.45	20,000	1,380
5Y5Y-9-12C	13/16"-16 UN	3/4"-14 NPS	2.50	63.50	1.37	34.80	20,000	1,380
5Y5Y-9-16C	13/16"-16 UN	1-3/8"-12 UNF	3.50	88.90	1.75	44.45	20,000	1,380
5Y5Y-12-16C	3/4"-14 NPS	1-3/8"-12 UNF	3.50	88.90	1.75	44.45	20,000	1,380

\*Non-standard part - may require longer lead time



### WARNING

This product can expose you to chemicals including Lead, which is known to the State of California to cause cancer and birth defects or other reproductive harm.

For more information go to [www.P65Warnings.ca.gov](http://www.P65Warnings.ca.gov).

# Medium Pressure Adapters

## 5Y6Y — Female Medium Pressure x Female High Pressure Coupling

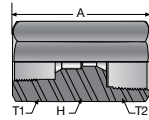

Part Number	T1 Thread Size	T2 Thread Size	A Overall Length		H Hex		Maximum Working Pressure	
			inch	mm	inch	mm	psi	bar
#								
5Y6Y-4-4C	7/16" -20 UNF	9/16" -18 UNF	1.62	41.15	0.75	19.05	20,000	1,380
5Y6Y-4-6C	7/16" -20 UNF	3/4" -16 UNF	1.87	47.50	1.00	25.40	20,000	1,380
5Y6Y-4-9C*	7/16" -20 UNF	1-1/8" -12 UNF	2.37	60.20	1.37	34.80	20,000	1,380
5Y6Y-6-4C	9/16" -18 UNF	9/16" -18 UNF	1.75	44.45	0.75	19.05	20,000	1,380
5Y6Y-6-6C	9/16" -18 UNF	3/4" -16 UNF	1.87	47.50	1.00	25.40	20,000	1,380
5Y6Y-6-9C	9/16" -18 UNF	1-1/8" -12 UNF	2.37	60.20	1.37	34.80	20,000	1,380
5Y6Y-9-4C	13/16" -16 UN	9/16" -18 UNF	2.12	53.85	1.00	25.40	20,000	1,380
5Y6Y-9-6C	13/16" -16 UN	3/4" -16 UNF	2.37	60.20	1.00	25.40	20,000	1,380
5Y6Y-9-9C	13/16" -16 UN	1-1/8" -12 UNF	1.75	44.45	1.37	34.80	20,000	1,380
5Y6Y-12-4C	3/4" -14 NPS	9/16" -18 UNF	2.50	63.50	1.37	34.80	20,000	1,380
5Y6Y-12-6C*	3/4" -14 NPS	3/4" -16 UNF	2.50	63.50	1.37	34.80	20,000	1,380
5Y6Y-12-9C	3/4" -14 NPS	1-1/8" -12 UNF	2.50	63.50	1.37	34.80	20,000	1,380
5Y6Y-16-4C	1-3/8" -12 UNF	9/16" -18 UNF	3.50	88.90	1.37	34.80	20,000	1,380
5Y6Y-16-6C*	1-3/8" -12 UNF	3/4" -16 UNF	3.50	88.90	1.37	34.80	20,000	1,380
5Y6Y-16-9C	1-3/8" -12 UNF	1-1/8" -12 UNF	3.50	88.90	1.37	34.80	20,000	1,380

\*Non-standard part - may require longer lead time

## L5Y — Medium Pressure Elbow

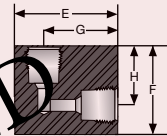

Part Number	Thread Size	Thick-ness	E		F		G		H		Max. Working Pressure	
			inch	mm	inch	mm	inch	mm	inch	mm	psi	bar
#												
L5Y-4C	7/16" -20 UNF	0.75	1.18	29.97	1.00	25.40	0.87	22.10	0.68	17.27	20,000	1,380
L5Y-6C	9/16" -18 UNF	0.75	1.37	34.80	1.37	34.80	1.00	25.40	1.00	25.40	20,000	1,380
L5Y-9C	13/16" -16 UN	1.00	1.75	44.45	1.75	44.45	1.25	31.75	1.25	31.75	20,000	1,380
L5Y-12C	3/4" -14 NPS	1.37	2.25	57.15	2.25	57.15	1.50	38.10	1.50	38.10	20,000	1,380
L5Y-16C	1-3/8" -12 UNF	1.75	3.00	76.20	3.00	76.20	2.06	52.32	2.06	52.32	20,000	1,380



**WARNING**

This product can expose you to chemicals including Lead, which is known to the State of California to cause cancer and birth defects or other reproductive harm.

For more information go to [www.P65Warnings.ca.gov](http://www.P65Warnings.ca.gov).



# Medium Pressure Adapters

## T5Y — Medium Pressure Tee

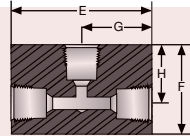

Part Number	Thread Size	Thick-ness	E		F		G		H		Max. Working Pressure	
			inch	mm	inch	mm	inch	mm	inch	mm	psi	bar
#												
T5Y-4C	7/16"-20 UNF	0.62	1.75	44.45	1.00	25.40	0.87	22.10	0.68	17.27	20,000	1,380
T5Y-6C	9/16"-18 UNF	0.75	2.00	50.80	1.37	34.80	1.00	25.40	1.00	25.40	20,000	1,380
T5Y-9C	13/16"-16 UN	1.00	2.50	63.50	1.75	44.45	1.25	31.75	1.25	31.75	20,000	1,380
T5Y-12C	3/4"-14 NPS	1.37	3.00	76.20	2.25	57.15	1.50	38.10	1.50	38.10	20,000	1,380
T5Y-16C	1-3/8"-12 UNF	1.75	4.12	104.65	3.60	76.20	2.06	52.32	2.06	52.32	20,000	1,380

## X5Y — Medium Pressure Cross

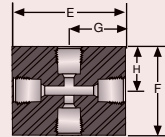

Part Number	Thread Size	Thick-ness	E		F		G		H		Max. Working Pressure	
			inch	mm	inch	mm	inch	mm	inch	mm	psi	bar
#												
X5Y-4C	7/16"-20 UNF	0.62	1.75	44.45	1.37	34.80	0.87	22.10	0.68	17.27	20,000	1,380
X5Y-6C	9/16"-18 UNF	0.75	2.00	50.80	2.00	50.80	1.00	25.40	1.00	25.40	20,000	1,380
X5Y-9C	13/16"-16 UN	1.00	2.50	63.50	2.50	63.50	1.25	31.75	1.25	31.75	20,000	1,380
X5Y-12C	3/4"-14 NPS	1.37	3.00	76.20	3.00	76.20	1.50	38.10	1.50	38.10	20,000	1,380
X5Y-16C	1-3/8"-12 UNF	1.75	4.12	104.65	4.12	104.65	2.06	52.32	2.06	52.32	20,000	1,380

## Y2N — Medium Pressure Gland Nut

Part Number	Thread Size	Hex Size		Maximum Working Pressure	
		inch	mm	psi	bar
#					
Y2N-4C	7/16"-20 UNF	0.50	12.70	20,000	1,380
Y2N-6C	9/16"-18 UNF	0.625	15.88	20,000	1,380
Y2N-9C	13/16"-16 UN	0.813	20.64	20,000	1,380
Y2N-12C	3/4"-14 NPS	0.75	19.05	20,000	1,380
Y2N-16C	1-3/8"-12 UNF	1.375	34.93	20,000	1,380

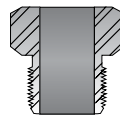

### WARNING

This product can expose you to chemicals including Lead, which is known to the State of California to cause cancer and birth defects or other reproductive harm. For more information go to [www.P65Warnings.ca.gov](http://www.P65Warnings.ca.gov).

# Medium Pressure Adapters

## Y2C Medium Pressure Collar



Part Number	Thread Size	Maximum Working Pressure	
		psi	bar
#			
Y2C-4C	1/4"-28 UNF LH	20,000	1,380
Y2C-6C	3/8"-24 UNF LH	20,000	1,380
Y2C-9C	9/16"-18 UNF LH	20,000	1,380
Y2C-12C	3/4"-16 UNF LH	20,000	1,380
Y2C-16C	1"-14 UNS LH	20,000	1,380

## HBPLM Medium Pressure Plug



Part Number	Tube Size (O.D.)	Maximum Working Pressure	
		psi	bar
#			
HBPLM4-B	1/4"	20,000	1,380
HBPLM6-B	3/8"	20,000	1,380
HBPLM9-B	9/16"	20,000	1,380
HBPLM12-B	3/4"	20,000	1,380
HBPLM16-B	1"	20,000	1,380

## Medium Pressure Caps

Part Number	Thread Size	Overall Length		Hex Size		Maximum Working Pressure	
		inch	mm	inch	mm	psi	bar
#							
5Y4C-CAP	7/16"-20 UNF	0.95	24.13	0.625	15.88	20,000	1,380
5Y6C-CAP	9/16"-18 UNF	1.38	35.05	0.875	22.23	20,000	1,380
5Y9C-CAP	13/16"-16 UN	1.50	38.10	1.25	31.75	20,000	1,380
5Y12C-CAP	3/4"-14 NPSM	1.85	46.99	1.375	34.93	20,000	1,380
5Y16C-CAP	1-3/8"-12 UNF	2.20	55.88	1.75	44.45	20,000	1,380

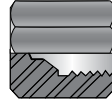

## Y204, Y206, Y209, Y212 and Y216 — Medium Pressure Nipple

Length	1/4" O.D.	3/8" O.D.	9/16" O.D.	3/4" O.D.	1" O.D.
2.75"	Y204-0275C				
3"	Y204-0300C	Y206-0300C			
4"	Y204-0400C	Y206-0400C	Y209-0400C	Y212-0400C	
6"	Y204-0600C	Y206-0600C	Y209-0600C	Y212-0600C	Y216-0600C
8"	Y204-0800C	Y206-0800C	Y209-0800C	Y212-0800C	Y216-0800C*
10"	Y204-1000C*	Y206-1000C	Y209-1000C*	Y212-1000C*	Y216-1000C*
12"	Y204-1200C	Y206-1200C	Y209-1200C*	Y212-1200C	Y216-1200C*



\*Non-standard part - may require longer lead time



### WARNING

This product can expose you to chemicals including Lead, which is known to the State of California to cause cancer and birth defects or other reproductive harm. For more information go to [www.P65Warnings.ca.gov](http://www.P65Warnings.ca.gov).

# High Pressure Adapters



High Pressure is a 58/60 degree coned and threaded tubing design. With small bore sizes, they have a **maximum working pressure rating of 60,000 psi.**

## Advantages:

- An industry standard for use at elevated pressures
- Suitable for repetitive assembly and disassembly

## Thread Sizes - determined by tubing OD:

- 04 1/4" O.D. x 0.08" I.D. — 9/16"-18 male thread on gland nut
- 06 3/8" O.D. x 0.12" I.D. — 3/4"-16 male thread on gland nut
- 09 9/16" O.D. x 0.18" I.D. — 1-1/8"-12 male thread on gland nut

## 6YY6 — Female High Pressure x Male High Pressure

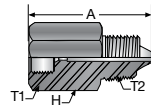

Part Number	T1 Thread Size	T2 Thread Size	A Overall Length		H Hex		Maximum Working Pressure	
			inch	mm	inch	mm	psi	bar
#								
6YY6-4-6C	9/16"-18 UNF	3/4"-16 UNF	1.75	44.45	0.75	19.05	60,000	4,140
6YY6-4-9C	9/16"-18 UNF	1-1/8"-12 UNF	2.12	53.85	1.12	28.45	60,000	4,140
6YY6-6-4C	3/4"-16 UNF	9/16"-18 UNF	1.50	38.10	1.00	25.40	60,000	4,140
6YY6-6-9C	3/4"-16 UNF	1-1/8"-12 UNF	2.12	53.85	1.12	28.45	60,000	4,140
6YY6-9-4C	1-1/8"-12 UNF	9/16"-18 UNF	1.75	44.45	1.37	34.80	60,000	4,140
6YY6-9-6C	1-1/8"-12 UNF	3/4"-16 UNF	1.87	47.50	1.37	34.80	60,000	4,140
6YY6-9-9C	1-1/8"-12 UNF	1-1/8"-12 UNF	2.26	57.40	1.375	34.93	60,000	4,140



### WARNING

This product can expose you to chemicals including Lead, which is known to the State of California to cause cancer and birth defects or other reproductive harm. For more information go to [www.P65Warnings.ca.gov](http://www.P65Warnings.ca.gov).

# High Pressure Adapters

## Y6Y6 — Male High Pressure x Male High Pressure

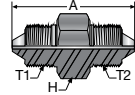

Part Number	T1 Thread Size	T2 Thread Size	A Overall Length		H Hex		Maximum Working Pressure	
			inch	mm	inch	mm	psi	bar
#								
Y6Y6-4-4C	9/16"-18 UNF	9/16"-18 UNF	1.68	42.67	0.62	15.75	60,000	4,140
Y6Y6-4-6C	9/16"-18 UNF	3/4"-16 UNF	2.06	52.32	0.75	19.05	60,000	4,140
Y6Y6-4-9C	9/16"-18 UNF	1-1/8"-12 UNF	2.25	57.15	1.12	28.45	60,000	4,140
Y6Y6-6-6C	3/4"-16 UNF	3/4"-16 UNF	2.25	57.15	0.75	19.05	60,000	4,140
Y6Y6-6-9C	3/4"-16 UNF	1-1/8"-12 UNF	2.50	63.50	1.12	28.45	60,000	4,140
Y6Y6-9-9C	1-1/8"-12 UNF	1-1/8"-12 UNF	2.62	66.55	1.12	28.45	60,000	4,140

## X6Y6 — Low Angle Face Seal x Male High Pressure

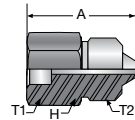

Part Number	T1 Thread Size	T2 Thread Size	A Overall Length		H Hex		Maximum Working Pressure	
			inch	mm	inch	mm	psi	bar
#								
X6Y6-6-9C*	9/16"-18 UNF	1-1/8"-12 UNF	2.00	50.80	1.125	28.58	60,000	4,140

\*Non-standard part - may require longer lead time

## 6Y6Y — Female / Female High Pressure, Straight Coupling

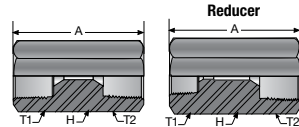

Part Number	T1 Thread Size	T2 Thread Size	A Overall Length		H Hex		Maximum Working Pressure	
			inch	mm	inch	mm	psi	bar
#								
6Y6Y-4-4C	9/16"-18 UNF	9/16"-18 UNF	1.75	44.45	1.00	25.40	60,000	4,140
6Y6Y-6-6C	3/4"-16 UNF	3/4"-16 UNF	2.00	50.80	1.00	25.40	60,000	4,140
6Y6Y-9-9C	1-1/8"-12 UNF	1-1/8"-12 UNF	2.37	60.20	1.37	34.80	60,000	4,140

## Reducer Coupling

			inch	mm	inch	mm	psi	bar
6Y6Y-4-6C	9/16"-18 UNF	3/4"-16 UNF	1.62	41.15	1.00	25.40	60,000	4,140
6Y6Y-4-9C	9/16"-18 UNF	1-1/8"-12 UNF	1.75	44.45	1.37	34.80	60,000	4,140
6Y6Y-6-9C	3/4"-16 UNF	1-1/8"-12 UNF	2.00	50.80	1.37	34.80	60,000	4,140



### WARNING

This product can expose you to chemicals including Lead, which is known to the State of California to cause cancer and birth defects or other reproductive harm.

For more information go to [www.P65Warnings.ca.gov](http://www.P65Warnings.ca.gov).

# High Pressure Adapters

## Y6D9 — Male High Pressure x Male BSP

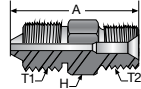

Part Number	T1 Thread Size	T2 Thread Size	A Overall Length		H Hex		Maximum Working Pressure	
			inch	mm	inch	mm	psi	bar
#								
Y6D9-4-6C	9/16"-18 UNF	G3/8-19	1.57	39.88	0.875	22.23	30,000*	2,070*
Y6D9-6-6C	3/4"-16 UNF	G3/8-19	1.85	46.99	0.875	22.23	30,000*	2,070*

\*BSP connection end lowers working pressure to 30,000psi

## L6Y — High Pressure Elbow

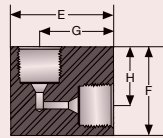

Part Number	Thread Size	Thick-ness	E		F		G		H		Max. Working Pressure	
			inch	mm	inch	mm	inch	mm	inch	mm	psi	bar
#												
L6Y-4C	9/16"-18 UNF	1.00	1.37	34.80	1.50	38.10	0.87	22.10	1.00	25.40	60,000	4,140
L6Y-6C	3/4"-16 UNF	1.00	1.75	44.45	1.50	38.10	1.25	31.75	1.00	25.40	60,000	4,140
L6Y-9C	1-1/8"-12 UNF	1.50	2.62	66.55	1.87	47.50	1.12	28.45	1.12	28.45	60,000	4,140

DISCONTINUED

## T6Y — High Pressure Tee

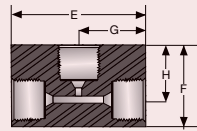

Part Number	Thread Size	Thick-ness	E		F		G		H		Max. Working Pressure	
			inch	mm	inch	mm	inch	mm	inch	mm	psi	bar
#												
T6Y-4C	9/16"-18 UNF	1.00	2.00	50.80	1.37	34.80	1.00	25.40	0.87	22.10	60,000	4,140
T6Y-6C	3/4"-16 UNF	1.00	2.00	50.80	1.56	39.62	1.00	25.40	1.06	26.92	60,000	4,140
T6Y-9C	1-1/8"-12 UNF	1.50	2.62	66.55	2.12	53.85	1.62	41.15	1.37	34.80	60,000	4,140



### WARNING

This product can expose you to chemicals including Lead, which is known to the State of California to cause cancer and birth defects or other reproductive harm. For more information go to [www.P65Warnings.ca.gov](http://www.P65Warnings.ca.gov).

Hose  
A  
Fittings  
B  
Adapters & Valves  
C  
Quick Couplings  
D  
Accessories  
E  
General Technical  
F

# High Pressure Adapters

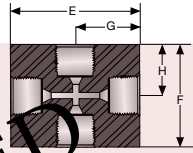

## X6Y — High Pressure Cross

Part Number	Thread Size	Thick-ness	E		F		G		H		Max. Working Pressure	
			inch	mm	inch	mm	inch	mm	inch	mm	psi	bar
#												
X6Y-4C	9/16"-18 UNF	1.00	2.00	50.80	1.50	38.10	1.00	25.40	0.75	19.05	60,000	4,140
X6Y-6C	3/4"-16 UNF	1.00	2.12	53.85	2.00	50.80	1.06	26.92	1.00	25.40	60,000	4,140
X6Y-9C	1-1/8"-12 UNF	1.50	2.75	69.85	2.62	66.55	1.37	34.80	1.31	33.27	60,000	4,140

DISCONTINUED

## Y4N — High Pressure Gland Nut

Part Number	Thread Size	Hex Size		Maximum Working Pressure	
		inch	mm	inch	mm
#					
Y4N-4C	9/16"-18 UNF	0.625	15.89	60,000	4,140
Y4N-6C	3/4"-16 UNF	0.813	20.64	60,000	4,140
Y4N-9C	1-1/8"-12 UNF	1.188	30.16	60,000	4,140

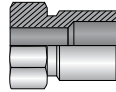

## Y4C High Pressure Collar



Part Number	Thread Size	Max. Working Pressure	
		psi	bar
#			
Y4C-4C	1/4"-28 UNF LH	60,000	4,140
Y4C-6C	3/8"-24 UNF LH	60,000	4,140
Y4C-9C	9/16"-18 UNF LH	60,000	4,140

## HBPBM High Pressure Plug

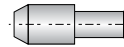

Part Number	Tube Size (O.D.)	Max. Working Pressure	
		psi	bar
#			
HBPBM4-B	1/4"	60,000	4,140
HBPBM6-B	3/8"	60,000	4,140
HBPBM9-B	9/16"	60,000	4,140



**WARNING**

This product can expose you to chemicals including Lead, which is known to the State of California to cause cancer and birth defects or other reproductive harm. For more information go to [www.P65Warnings.ca.gov](http://www.P65Warnings.ca.gov).

# High Pressure Adapters

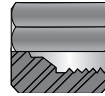

## High Pressure Caps

Part Number	Thread Size	Overall Length		Hex Size		Maximum Working Pressure	
		inch	mm	inch	mm	inch	mm
#							
6Y4C-CAP	1/4" HP	1.07	27.18	0.875	22.23	60,000	4,140
6Y6C-CAP	3/8" HP	1.26	32.00	1.000	25.40	60,000	4,140
6Y9C-CAP	9/16" HP	1.50	38.10	1.375	34.93	60,000	4,140

## Locking Nut/Collar Anti-Vibration

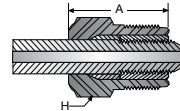

Part Number	Tube Size (O.D.)	Thread Size	A Length		H Hex	
			inch	mm	inch	mm
#						
KCGL40-316-ACL40*	1/4" HP	9/16"-18 UNF	0.68	17.27	0.63	16.00
KCGL60-316-ACL60	3/8" HP	3/4"-16 UNF	1.06	26.92	0.68	17.27
KCGL90-316-ACL90	9/16" HP	1-1/8"-12 UNF	1.56	39.62	1.68	42.67

\*Non-standard part - may require longer lead time

## Y404, Y406 and Y409 High Pressure Nipple



Length	1/4" O.D.	3/8" O.D.	9/16" O.D.
2.75"	Y404-0275C		
3"	Y404-0300C	Y406-0300C	
4"	Y404-0400C	Y406-0400C	Y409-0400C
6"	Y404-0600C	Y406-0600C	Y409-0600C
8"	Y404-0800C	Y406-0800C	Y409-0800C
10"	Y404-1000C*	Y406-1000C	Y409-1000C*
12"	Y404-1200C	Y406-1200C	Y409-1200C*

\*Non-standard part - may require longer lead time



### WARNING

This product can expose you to chemicals including Lead, which is known to the State of California to cause cancer and birth defects or other reproductive harm. For more information go to [www.P65Warnings.ca.gov](http://www.P65Warnings.ca.gov).

# NPT Adapters



**polyflex** offers a broad range of high quality stainless steel high pressure NPT adapters. Sizes ranging from 1/16" to 1/2" are rated up to **15,000 psi**; 3/4" and above are rated to **10,000 psi**.

## Advantages:

- Used world-wide in OEM and MRO applications
- Compact size make NPT a suitable selection for plumbing in limited or tight space in a compact system

## Thread Sizes:

-01	1/16"-27
-02	1/8"-27
-04	1/4"-18
-06	3/8"-18
-08	1/2"-14
-12	3/4"-16 UNF
-16	1"-11-1/2



## WARNING

This product can expose you to chemicals including Lead, which is known to the State of California to cause cancer and birth defects or other reproductive harm. For more information go to [www.P65Warnings.ca.gov](http://www.P65Warnings.ca.gov).



# NPT Adapters

## K0101— Male NPT x Male NPT

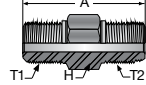

Part Number	T1 Thread Size	T2 Thread Size	A Overall Length		H Hex		Maximum Working Pressure	
			inch	mm	inch	mm	psi	bar
#								
10K0101-12-12C	3/4"-14 NPT	3/4"-14 NPT	2.44	61.98	1.13	28.70	10,000	690
10K0101-16-16C	1"-11-1/2 NPT	1"-11-1/2 NPT	2.75	69.85	1.38	35.05	10,000	690
15K0101-1-1C	1/16"-27 NPT	1/16"-27 NPT	1.00	25.40	0.38	9.65	15,000	1,030
15K0101-2-2C	1/8"-27 NPT	1/8"-27 NPT	1.20	30.48	0.50	12.70	15,000	1,030
15K0101-4-4C	1/4"-18 NPT	1/4"-18 NPT	1.44	36.58	0.63	16.00	15,000	1,030
15K0101-6-6C	3/8"-18 NPT	3/8"-18 NPT	1.70	43.18	0.75	19.05	15,000	1,030
15K0101-8-8C	1/2"-14 NPT	1/2"-14 NPT	2.25	57.15	1.00	25.40	15,000	1,030
15K0101-2-1C	1/8"-27 NPT	1/16"-27 NPT	1.13	28.70	0.50	12.70	15,000	1,030
15K0101-2-4C	1/8"-27 NPT	1/4"-18 NPT	1.35	34.29	0.625	15.88	15,000	1,030
15K0101-6-8C	3/8"-18 NPT	1/2"-14 NPT	1.85	46.99	1.00	25.40	15,000	1,030
10K0101-12-6C	3/4"-14 NPT	3/8"-18 NPT	1.95	49.53	1.125	28.58	10,000	690
10K0101-16-6C	1"-11-1/2 NPT	3/8"-18 NPT	2.16	54.86	1.375	34.93	10,000	690
10K0101-12-4C	3/4"-14 NPT	1/4"-18 NPT	2.03	51.56	1.125	28.58	10,000	690
10K0101-16-4C	1"-11-1/2 NPT	1/4"-18 NPT	2.16	54.86	1.375	34.93	10,000	690
10K0101-16-12C	1"-11-1/2 NPT	3/4"-14 NPT	2.56	65.02	1.375	34.93	10,000	690



### WARNING

This product can expose you to chemicals including Lead, which is known to the State of California to cause cancer and birth defects or other reproductive harm. For more information go to [www.P65Warnings.ca.gov](http://www.P65Warnings.ca.gov).

# NPT Adapters

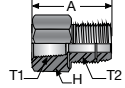

## K0201— Female NPT x Male NPT

Part Number #	T1 Thread Size	T2 Thread Size	A Overall Length		H Hex		Maximum Working Pressure	
			inch	mm	inch	mm	psi	bar
15K0201-1-8C	1/16"-27 NPT	1/2"-14 NPT	1.25	31.75	0.87	22.10	15,000	1,030
15K0201-2-8C	1/8"-27 NPT	1/2"-14 NPT	1.25	31.75	0.87	22.10	15,000	1,030
15K0201-4-8C	1/4"-18 NPT	1/2"-14 NPT	1.25	31.75	0.87	22.10	15,000	1,030
15K0201-6-8C	3/8"-18 NPT	1/2"-14 NPT	1.63	41.40	1.00	25.40	15,000	1,030
15K0201-1-4C	1/16"-27 NPT	1/4"-18 NPT	1.30	33.02	0.625	15.88	15,000	1,030
15K0201-2-1C	1/8"-27 NPT	1/16"-27 NPT	1.38	35.05	0.75	19.05	15,000	1,030
15K0201-4-1C	1/4"-18 NPT	1/16"-27 NPT	1.56	39.62	0.875	22.23	15,000	1,030
15K0201-4-6C	1/4"-18 NPT	3/8"-18 NPT	1.50	38.10	0.87	22.10	15,000	1,030
15K0201-6-2C	3/8"-18 NPT	1/8"-27 NPT	1.58	40.13	1.00	25.40	15,000	1,030
15K0201-6-6C	3/8"-18 NPT	3/8"-18 NPT	1.78	45.21	1.00	25.40	15,000	1,030
15K0201-8-8C	1/2"-14 NP	1/2"-14 NPT	2.13	54.10	1.25	31.75	15,000	1,030
10K0201-4-12C	1/4"-18 NPT	3/4"-14 NPT	1.63	41.40	1.125	28.58	10,000	690
10K0201-6-12C	3/8"-18 NPT	3/4"-14 NPT	1.60	40.64	1.125	28.58	10,000	690
10K0201-6-16C	3/8"-18 NPT	1"-11-1/2 NPT	1.90	48.26	1.375	34.93	10,000	690
10K0201-12-6C	3/4"-14 NPT	3/8"-18 NPT	2.25	57.15	1.50	38.10	10,000	690
10K0201-12-12C	3/4"-14 NPT	3/4"-14 NPT	2.25	57.15	1.50	38.10	10,000	690
10K0201-12-16C	3/4"-14 NPT	1"-11-1/2 NPT	2.25	57.15	1.50	38.10	10,000	690
10K0201-16-6C	1"-11-1/2 NPT	3/8"-18 NPT	2.35	59.69	2.00	50.80	10,000	690
10K0201-16-8C	1"-11-1/2 NPT	1/2"-14 NPT	2.50	63.50	2.00	50.80	10,000	690



**WARNING**

This product can expose you to chemicals including Lead, which is known to the State of California to cause cancer and birth defects or other reproductive harm. For more information go to [www.P65Warnings.ca.gov](http://www.P65Warnings.ca.gov).

# NPT Adapters

## K0202— Female NPT x Female NPT

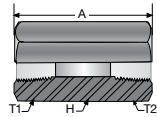

Part Number #	T1 Thread Size	T2 Thread Size	A Overall Length		H Hex		Maximum Working Pressure	
			inch	mm	inch	mm	psi	bar
15K0202-2-2C	1/8" -27 NPT	1/8" -27 NPT	1.50	38.10	0.75	19.05	15,000	1,030
15K0202-4-1C	1/4" -18 NPT	1/16" -27 NPT	1.63	41.40	0.875	22.23	15,000	1,030
15K0202-4-4C	1/4" -18 NPT	1/4" -18 NPT	1.75	44.45	0.87	22.10	15,000	1,030
15K0202-6-2C	3/8" -18 NPT	1/8" -27 NPT	1.75	44.45	1.00	25.40	15,000	1,030
15K0202-6-6C	3/8" -18 NPT	3/8" -18 NPT	1.75	44.45	1.00	25.40	15,000	1,030
15K0202-8-1C	1/2" -14 NPT	1/16" -27 NPT	1.75	44.45	1.25	31.75	15,000	1,030
15K0202-8-2C	1/2" -14 NPT	1/8" -27 NPT	1.75	44.45	1.25	31.75	15,000	1,030
15K0202-8-6C	1/2" -14 NPT	3/8" -18 NPT	1.75	44.45	1.25	31.75	15,000	1,030
15K0202-8-8C	1/2" -14 NPT	1/2" -14 NPT	2.13	54.10	1.25	31.75	15,000	1,030
10K0202-12-4C	3/4" -14 NPT	1/4" -18 NPT	2.00	50.80	1.50	38.10	10,000	690
10K0202-12-6C	3/4" -14 NPT	3/8" -18 NPT	2.00	50.80	1.50	38.10	10,000	690
10K0202-12-12C	3/4" -14 NPT	3/4" -14 NPT	2.13	54.10	1.50	38.10	10,000	690
10K0202-12-16C	3/4" -14 NPT	1" -11-1/2 NPT	2.38	60.45	2.00	50.80	10,000	690
10K0202-16-16C	1" -11-1/2 NPT	1" -11-1/2 NPT	2.50	63.50	2.00	50.80	10,000	690

## YA02 — Male Type "M" x Female NPT

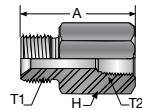

Part Number #	T1 Thread Size	T2 Thread Size	A Overall Length		H Hex		Maximum Working Pressure	
			inch	mm	inch	mm	psi	bar
YA02-6-4C	9/16" -18 UNF	1/4" -18 NPT	1.50	38.10	0.75	19.05	15,000	1,030
YA02-6-8C	9/16" -18 UNF	1/2" -14 NPT	2.00	50.80	1.25	31.75	15,000	1,030
YA02-6-16C	9/16" -18 UNF	1" -11-1/2 NPT	2.38	60.45	2.00	50.80	10,000	690
YA02-8-4C	3/4" -16 UNF	1/4" -18 NPT	1.63	41.40	0.875	22.23	15,000	1,030
YA02-8-6C	3/4" -16 UNF	3/8" -18 NPT	1.75	44.45	1.00	25.40	15,000	1,030
YA02-8-8C	3/4" -16 UNF	1/2" -14 NPT	2.00	50.80	1.25	31.75	15,000	1,030
YA02-8-12C	3/4" -16 UNF	3/4" -14 NPT	2.13	54.10	1.50	38.10	10,000	690
YA02-11-8C	1" -12 UNF	1/2" -14 NPT	2.50	63.50	1.00	25.40	15,000	1,030
YA02-11-12C	1" -12 UNF	3/4" -14 NPT	2.13	54.10	1.50	38.10	10,000	690
YA02-16-16C	1-5/16" -12 UNF	1" -11-1/2 NPT	2.38	60.45	2.00	50.80	10,000	690



### WARNING

This product can expose you to chemicals including Lead, which is known to the State of California to cause cancer and birth defects or other reproductive harm. For more information go to [www.P65Warnings.ca.gov](http://www.P65Warnings.ca.gov).

# NPT Adapters

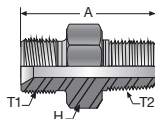

## YA01 — Male Type “M” x Male NPT

Part Number	T1 Thread Size	T2 Thread Size	A Overall Length		H Hex		Maximum Working Pressure	
			inch	mm	inch	mm	psi	bar
#								
YA01-6-2C	9/16"-18 UNF	1/8"-27 NPT	1.28	32.51	0.63	16.00	15,000	1,030
YA01-6-4C	9/16"-18 UNF	1/4"-18 NPT	1.38	35.05	0.63	16.00	15,000	1,030
YA01-6-6C	9/16"-18 UNF	3/8"-18 NPT	1.57	39.88	0.75	19.05	15,000	1,030
YA01-6-8C	9/16"-18 UNF	1/2"-14 NPT	1.75	44.45	0.88	22.35	15,000	1,030
YA01-6-12C	9/16"-18 UNF	3/4"-14 NPT	1.95	49.53	1.13	28.58	10,000	690
YA01-6-16C	9/16"-18 UNF	1"-11-1/2 NPT	2.26	57.40	1.38	34.93	10,000	690
YA01-8-4C	3/4"-16 UNF	1/4"-18 NPT	1.8	45.72	0.75	19.05	15,000	1,030
YA01-8-6C	3/4"-16 UNF	3/8"-18 NPT	1.73	43.94	0.75	19.05	15,000	1,030
YA01-8-8C	3/4"-16 UNF	1/2"-14 NPT	1.95	49.53	0.88	22.35	15,000	1,030
YA01-8-12C	3/4"-16 UNF	3/4"-14 NPT	2.13	54.10	1.13	28.70	10,000	690
YA01-8-16C	3/4"-16 UNF	1"-11-1/2 NPT	2.38	60.45	1.38	35.05	10,000	690
YA01-11-6C	1"-12 UNF	3/8"-18 NPT	1.85	46.99	1.00	25.40	15,000	1,030
YA01-11-8C	1"-12 UNF	1/2"-14 NPT	2.00	50.80	1.00	25.40	15,000	1,030
YA01-11-12C	1"-12 UNF	3/4"-14 NPT	2.13	54.10	1.13	28.70	10,000	690
YA01-11-16C	1"-12 UNF	1"-11-1/2 NPT	2.38	60.45	1.38	35.05	10,000	690
YA01-16-8C	1-5/16"-12 UN	1/2"-14 NPT	2.13	54.10	1.38	35.05	15,000	1,030
YA01-16-12C	1-5/16"-12 UN	3/4"-14 NPT	2.38	60.45	1.38	35.05	10,000	690
YA01-16-16C	1-5/16"-12 UN	1"-11-1/2 NPT	2.5	63.50	1.38	35.05	10,000	690
YA01-16-20C	1-5/16"-12 UN	1-1/4"-11-1/2 NPT	2.75	69.85	1.75	44.45	10,000	690
YA01-16-24C	1-5/16"-12 UN	1-1/2"-11-1/2 NPT	2.75	69.85	2.00	50.80	7,500	520



### WARNING

This product can expose you to chemicals including Lead, which is known to the State of California to cause cancer and birth defects or other reproductive harm. For more information go to [www.P65Warnings.ca.gov](http://www.P65Warnings.ca.gov).

# NPT Adapters

## 5Y01 — Female Medium Pressure x Male NPT

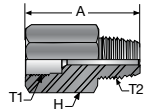

Part Number #	T1 Thread Size	T2 Thread Size	A Overall Length		H Hex		Maximum Working Pressure	
			inch	mm	inch	mm	psi	bar
5Y01-4-2C	7/16"-20 UNF	1/8"-27 NPT	1.43	36.32	0.75	19.05	15,000	1,030
5Y01-4-4C	7/16"-20 UNF	1/4"-18 NPT	1.62	41.15	0.75	19.05	15,000	1,030
5Y01-4-6C	7/16"-20 UNF	3/8"-18 NPT	1.62	41.15	0.75	19.05	15,000	1,030
5Y01-4-8C	7/16"-20 UNF	1/2"-14 NPT	1.75	44.45	1.00	25.40	15,000	1,030
5Y01-4-12C	7/16"-20 UNF	3/4"-14 NPT	1.87	47.50	1.37	34.80	10,000	690
5Y01-4-16C*	7/16"-20 UNF	1"-11-1/2 NPT	1.87	47.50	1.37	34.80	10,000	690
5Y01-6-2C*	9/16"-18 UNF	1/8"-27 NPT	1.43	36.32	0.75	19.05	15,000	1,030
5Y01-6-4C	9/16"-18 UNF	1/4"-18 NPT	1.62	41.15	0.75	19.05	15,000	1,030
5Y01-6-6C	9/16"-18 UNF	3/8"-18 NPT	1.62	41.15	0.75	19.05	15,000	1,030
5Y01-6-8C	9/16"-18 UNF	1/2"-14 NPT	1.74	44.20	1.00	25.40	15,000	1,030
5Y01-6-12C	9/16"-18 UNF	3/4"-14 NPT	1.87	47.50	1.37	34.80	10,000	690
5Y01-6-16C	9/16"-18 UNF	1"-11-1/2 NPT	1.87	47.50	1.37	34.80	10,000	690
5Y01-9-2C*	13/16"-16 UN	1/8"-27 NPT	1.87	47.50	1.00	25.40	15,000	1,030
5Y01-9-4C	13/16"-16 UN	1/4"-18 NPT	1.87	47.50	1.00	25.40	15,000	1,030
5Y01-9-6C	13/16"-16 UN	3/8"-18 NPT	1.87	47.50	1.00	25.40	15,000	1,030
5Y01-9-8C	13/16"-16 UN	1/2"-14 NPT	1.87	47.50	1.00	25.40	15,000	1,030
5Y01-9-12C	13/16"-16 UN	3/4"-14 NPT	1.87	47.50	1.37	34.80	10,000	690
5Y01-9-16C	13/16"-16 UN	1"-11-1/2 NPT	1.87	47.50	1.37	34.80	10,000	690
5Y01-12-2C*	3/4"-14 NPS	1/8"-27 NPT	2.50	63.50	1.37	34.80	15,000	1,030
5Y01-12-4C	3/4"-14 NPS	1/4"-18 NPT	2.50	63.50	1.37	34.80	15,000	1,030
5Y01-12-6C*	3/4"-14 NPS	3/8"-18 NPT	2.50	63.50	1.37	34.80	15,000	1,030
5Y01-12-8C	3/4"-14 NPS	1/2"-14 NPT	2.50	63.50	1.37	34.80	15,000	1,030
5Y01-12-12C	3/4"-14 NPS	3/4"-14 NPT	2.50	63.50	1.37	34.80	10,000	690
5Y01-12-16C	3/4"-14 NPS	1"-11-1/2 NPT	2.50	63.50	1.37	34.80	10,000	690
5Y01-16-2C*	1-3/8"-12 UNF	1/8"-27 NPT	2.50	63.50	1.75	34.80	15,000	1,030
5Y01-16-4C	1-3/8"-12 UNF	1/4"-18 NPT	2.50	63.50	1.75	34.80	15,000	1,030
5Y01-16-6C*	1-3/8"-12 UNF	3/8"-18 NPT	2.50	63.50	1.75	34.80	15,000	1,030
5Y01-16-8C	1-3/8"-12 UNF	1/2"-14 NPT	2.50	63.50	1.75	34.80	15,000	1,030
5Y01-16-12C	1-3/8"-12 UNF	3/4"-14 NPT	2.50	63.50	1.75	34.80	10,000	690
5Y01-16-16C	1-3/8"-12 UNF	1"-11-1/2 NPT	2.50	63.50	1.75	34.80	10,000	690

\*Non-standard part - may require longer lead time



### WARNING

This product can expose you to chemicals including Lead, which is known to the State of California to cause cancer and birth defects or other reproductive harm.

For more information go to [www.P65Warnings.ca.gov](http://www.P65Warnings.ca.gov).

# NPT Adapters

## 02Y5 — Female NPT x Male Medium Pressure

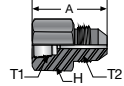

Part Number #	T1 Thread Size	T2 Thread Size	A Overall Length		H Hex		Maximum Working Pressure	
			inch	mm	inch	mm	psi	bar
02Y5-1-9C	1/16"-27 NPT	13/16"-16 UN	2.00	50.80	1.12	28.45	15,000	1,030
02Y5-2-4C	1/8"-27 NPT	7/16"-20 UNF	1.75	44.45	0.75	19.05	15,000	1,030
02Y5-2-6C	1/8"-27 NPT	9/16"-18 UNF	1.87	47.50	0.75	19.05	15,000	1,030
02Y5-2-9C	1/8"-27 NPT	13/16"-16 UN	1.87	47.50	0.87	22.10	15,000	1,030
02Y5-2-12C	1/8"-27 NPT	3/4"-14 NPSM	2.00	50.80	1.12	28.45	15,000	1,030
02Y5-2-16C*	1/8"-27 NPT	1-3/8"-12 UNF	3.00	76.20	1.00	25.40	15,000	1,030
02Y5-4-4C	1/4"-18 NPT	7/16"-20 UNF	1.75	44.45	0.75	19.05	15,000	1,030
02Y5-4-6C	1/4"-18 NPT	9/16"-18 UNF	1.87	47.50	0.75	19.05	15,000	1,030
02Y5-4-9C	1/4"-18 NPT	13/16"-16 UN	1.87	47.50	0.87	22.10	15,000	1,030
02Y5-4-12C	1/4"-18 NPT	3/4"-14 NPSM	2.00	50.80	1.12	28.45	15,000	1,030
02Y5-4-16C	1/4"-18 NPT	1-3/8"-12 UNF	3.00	76.20	1.00	25.40	15,000	1,030
02Y5-6-4C	3/8"-18 NPT	7/16"-20 UNF	2.00	50.80	1.00	25.40	15,000	1,030
02Y5-6-6C	3/8"-18 NPT	9/16"-18 UNF	2.12	53.85	1.00	25.40	15,000	1,030
02Y5-6-9C	3/8"-18 NPT	13/16"-16 UN	2.25	57.15	1.00	25.40	15,000	1,030
02Y5-6-12C	3/8"-18 NPT	3/4"-14 NPSM	2.00	50.80	1.12	28.45	15,000	1,030
02Y5-6-16C	3/8"-18 NPT	1-3/8"-12 UNF	3.00	76.20	1.00	25.40	15,000	1,030
02Y5-8-4C	1/2"-14 NPT	7/16"-20 UNF	2.12	53.85	1.12	28.45	15,000	1,030
02Y5-8-6C	1/2"-14 NPT	9/16"-18 UNF	1.25	31.75	1.12	28.45	15,000	1,030
02Y5-8-9C	1/2"-14 NPT	13/16"-16 UN	2.37	60.20	1.12	28.45	15,000	1,030
02Y5-8-12C	1/2"-14 NPT	3/4"-14 NPSM	2.50	63.50	1.12	28.45	15,000	1,030
02Y5-8-16C	1/2"-14 NPT	1-3/8"-12 UNF	3.75	95.25	1.12	28.45	15,000	1,030
02Y5-12-4C*	3/4"-14 NPT	7/16"-20 UNF	2.37	60.20	1.37	34.80	10,000	690
02Y5-12-6C	3/4"-14 NPT	9/16"-18 UNF	2.50	63.50	1.37	34.80	10,000	690
02Y5-12-9C	3/4"-14 NPT	13/16"-16 UN	2.62	66.55	1.37	34.80	10,000	690
02Y5-12-12C	3/4"-14 NPT	3/4"-14 NPSM	2.75	69.85	1.50	38.10	10,000	690
02Y5-12-16C	3/4"-14 NPT	1-3/8"-12 UNF	4.12	104.65	1.50	38.10	10,000	690
02Y5-16-6C	1-3/8"-12 UNF	9/16"-18 UNF	2.87	72.90	1.87	47.50	10,000	690
02Y5-16-9C	1-3/8"-12 UNF	13/16"-16 UN	3.00	76.20	1.87	47.50	10,000	690
02Y5-16-12C	1-3/8"-12 UNF	3/4"-14 NPSM	3.00	76.20	1.87	47.50	10,000	690
02Y5-16-16C	1-3/8"-12 UNF	1-3/8"-12 UNF	4.37	111.00	1.87	47.50	10,000	690

\*Non-standard part - may require longer lead time



**WARNING**

This product can expose you to chemicals including Lead, which is known to the State of California to cause cancer and birth defects or other reproductive harm.

For more information go to [www.P65Warnings.ca.gov](http://www.P65Warnings.ca.gov).

# NPT Adapters

## Y501 — Male Medium Pressure x Male NPT

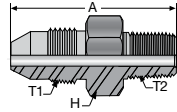

Part Number	T1 Thread Size	T2 Thread Size	A Overall Length		H Hex		Maximum Working Pressure	
			inch	mm	inch	mm	psi	bar
#								
Y501-4-4C	7/16"-20 UNF	1/4"-18 NPT	1.60	40.64	0.63	16.00	15,000	1,030
Y501-4-8C	7/16"-20 UNF	1/2"-14 NPT	2.12	53.85	0.87	22.10	15,000	1,030
Y501-6-4C	9/16"-18 UNF	1/4"-18 NPT	2.06	52.32	0.75	19.05	15,000	1,030
Y501-6-6C	9/16"-18 UNF	3/8"-18 NPT	2.06	52.32	0.75	19.05	15,000	1,030
Y501-6-8C	9/16"-18 UNF	1/2"-14 NPT	2.18	55.37	0.87	22.10	15,000	1,030
Y501-9-2C*	13/16"-16 UN	1/8"-27 NPT	2.12	53.85	0.87	22.10	15,000	1,030
Y501-9-4C	13/16"-16 UN	1/4"-18 NPT	2.25	57.15	0.87	22.10	15,000	1,030
Y501-9-6C	13/16"-16 UN	3/8"-18 NPT	2.25	57.15	0.87	22.10	15,000	1,030
Y501-9-8C	13/16"-16 UN	1/2"-14 NPT	2.37	60.20	0.87	22.10	15,000	1,030
Y501-9-12C	13/16"-16 UN	3/4"-14 NPT	2.62	66.55	1.12	28.45	10,000	690
Y501-9-16C	13/16"-16 UN	1"-11-1/2 NPT	2.62	66.55	1.37	34.80	10,000	690
Y501-12-2C*	3/4"-14 NPS	1/8"-27 NPT	2.37	60.20	1.12	28.45	15,000	1,030
Y501-12-4C*	3/4"-14 NPS	1/4"-18 NPT	2.50	63.50	1.12	28.45	15,000	1,030
Y501-12-6C*	3/4"-14 NPS	3/8"-18 NPT	2.50	63.50	1.12	28.45	15,000	1,030
Y501-12-8C	3/4"-14 NPS	1/2"-14 NPT	2.62	66.55	1.12	28.45	15,000	1,030
Y501-12-12C	3/4"-14 NPS	3/4"-14 NPT	2.75	69.85	1.12	28.45	10,000	690
Y501-12-16C	3/4"-14 NPS	1"-11-1/2 NPT	3.00	76.20	1.37	34.80	10,000	690
Y501-16-2C*	1-3/8"-12 UNF	1/8"-27 NPT	3.62	91.95	1.00	25.40	15,000	1,030
Y501-16-4C	1-3/8"-12 UNF	1/4"-18 NPT	3.75	95.25v	1.00	25.40	15,000	1,030
Y501-16-6C	1-3/8"-12 UNF	3/8"-18 NPT	3.75	95.25	1.00	25.40	15,000	1,030
Y501-16-8C	1-3/8"-12 UNF	1/2"-14 NPT	3.87	98.30	1.00	25.40	15,000	1,030
Y501-16-12C	1-3/8"-12 UNF	3/4"-14 NPT	3.87	98.30	1.12	28.45	10,000	690
Y501-16-16C	1-3/8"-12 UNF	1"-11-1/2 NPT	4.00	101.60	1.37	34.80	10,000	690

\*Non-standard part - may require longer lead time



### WARNING

This product can expose you to chemicals including Lead, which is known to the State of California to cause cancer and birth defects or other reproductive harm. For more information go to [www.P65Warnings.ca.gov](http://www.P65Warnings.ca.gov).

# NPT Adapters

## 5Y02 — Female Medium Pressure x Female NPT Coupling

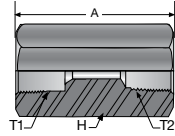

Part Number #	T1 Thread Size	T2 Thread Size	A Overall Length		H Hex		Maximum Working Pressure	
			inch	mm	inch	mm	psi	bar
5Y02-4-2C	7/16"-20 UNF	1/8"-27 NPT	1.62	41.15	0.75	19.05	15,000	1,030
5Y02-4-4C	7/16"-20 UNF	1/4"-18 NPT	1.62	41.15	0.75	19.05	15,000	1,030
5Y02-4-6C	7/16"-20 UNF	3/8"-18 NPT	2.00	50.80	1.00	25.40	15,000	1,030
5Y02-4-8C	7/16"-20 UNF	1/2"-14 NPT	2.00	50.80	1.12	28.45	15,000	1,030
5Y02-4-12C*	7/16"-20 UNF	3/4"-14 NPT	2.37	60.20	1.37	34.80	10,000	690
5Y02-4-16C*	7/16"-20 UNF	1"-11-1/2 NPT	2.62	66.55	2.00	50.80	10,000	690
5Y02-6-2C	9/16"-18 UNF	1/8"-27 NPT	1.75	44.45	0.75	19.05	15,000	1,030
5Y02-6-4C	9/16"-18 UNF	1/4"-18 NPT	1.75	44.45	0.75	19.05	15,000	1,030
5Y02-6-6C	9/16"-18 UNF	3/8"-18 NPT	2.12	53.85	1.00	25.40	15,000	1,030
5Y02-6-8C	9/16"-18 UNF	1/2"-14 NPT	2.12	53.85	1.12	28.45	15,000	1,030
5Y02-6-12C	9/16"-18 UNF	3/4"-14 NPT	2.37	60.20	1.37	34.80	10,000	690
5Y02-6-16C*	9/16"-18 UNF	1"-11-1/2 NPT	2.75	69.85	2.00	50.80	10,000	690
5Y02-9-2C*	13/16"-16 UN	1/8"-27 NPT	2.12	53.85	1.00	25.40	15,000	1,030
5Y02-9-4C	13/16"-16 UN	1/4"-18 NPT	2.12	53.85	1.00	25.40	15,000	1,030
5Y02-9-6C	13/16"-16 UN	3/8"-18 NPT	2.12	53.85	1.00	25.40	15,000	1,030
5Y02-9-8C	13/16"-16 UN	1/2"-14 NPT	2.25	57.15	1.12	28.45	15,000	1,030
5Y02-9-12C	13/16"-16 UN	3/4"-14 NPT	2.50	63.50	1.37	34.80	10,000	690
5Y02-9-16C*	13/16"-16 UN	1"-11-1/2 NPT	2.87	72.90	2.00	50.80	10,000	690
5Y02-12-2C*	3/4"-14 NPS	1/8"-27 NPT	2.50	63.50	1.37	34.80	15,000	1,030
5Y02-12-4C*	3/4"-14 NPS	1/4"-18 NPT	2.50	63.50	1.37	34.80	15,000	1,030
5Y02-12-6C*	3/4"-14 NPS	3/8"-18 NPT	2.50	63.50	1.37	34.80	15,000	1,030
5Y02-12-8C	3/4"-14 NPS	1/2"-14 NPT	2.50	63.50	1.37	34.80	15,000	1,030
5Y02-12-12C	3/4"-14 NPS	3/4"-14 NPT	2.75	69.85	1.50	38.10	10,000	690
5Y02-12-16C	3/4"-14 NPS	1"-11-1/2 NPT	3.00	76.20	1.87	47.50	15,000	1,030
5Y02-16-2C*	1-3/8"-12 UNF	1/8"-27 NPT	3.00	76.20	1.75	44.45	15,000	1,030
5Y02-16-4C*	1-3/8"-12 UNF	1/4"-18 NPT	3.00	76.20	1.75	44.45	15,000	1,030
5Y02-16-6C*	1-3/8"-12 UNF	3/8"-18 NPT	3.00	76.20	1.75	44.45	15,000	1,030
5Y02-16-8C*	1-3/8"-12 UNF	1/2"-14 NPT	3.00	76.20	1.75	44.45	15,000	1,030
5Y02-16-12C	1-3/8"-12 UNF	3/4"-14 NPT	3.50	88.90	1.50	38.10	10,000	690
5Y02-16-16C	1-3/8"-12 UNF	1"-11-1/2 NPT	3.75	95.25	1.87	47.50	10,000	690

\*Non-standard part - may require longer lead time



**WARNING**

This product can expose you to chemicals including Lead, which is known to the State of California to cause cancer and birth defects or other reproductive harm.

For more information go to [www.P65Warnings.ca.gov](http://www.P65Warnings.ca.gov).



# NPT Adapters

## 6Y02 — Female High Pressure x Female NPT Coupling

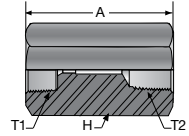

Part Number	T1 Thread Size	T2 Thread Size	A Overall Length		H Hex		Maximum Working Pressure	
			inch	mm	inch	mm	psi	bar
#								
6Y02-4-2C*	9/16"-18 UNF	1/8"-27 NPT	1.50	38.10	1.00	25.40	15,000	1,030
6Y02-4-4C	9/16"-18 UNF	1/4"-18 NPT	1.50	38.10	1.00	25.40	15,000	1,030
6Y02-4-6C	9/16"-18 UNF	3/8"-18 NPT	1.87	47.50	1.00	25.40	15,000	1,030
6Y02-4-8C	9/16"-18 UNF	1/2"-14 NPT	1.87	47.50	1.12	28.45	15,000	1,030
6Y02-4-12C	9/16"-18 UNF	3/4"-14 NPT	2.00	50.80	1.62	41.15	10,000	690
6Y02-4-16C*	9/16"-18 UNF	1"-11-1/2 NPT	2.50	63.50	1.75	44.45	10,000	690
6Y02-6-2C	3/4"-16 UNF	1/8"-27 NPT	1.87	47.50	1.00	25.40	15,000	1,030
6Y02-6-4C	3/4"-16 UNF	1/4"-18 NPT	1.87	47.50	1.00	25.40	15,000	1,030
6Y02-6-6C	3/4"-16 UNF	3/8"-18 NPT	1.87	47.50	1.00	25.40	15,000	1,030
6Y02-6-8C	3/4"-16 UNF	1/2"-14 NPT	1.87	47.50	1.12	28.45	15,000	1,030
6Y02-6-12C	3/4"-16 UNF	3/4"-14 NPT	2.12	53.85	1.37	34.80	10,000	690
6Y02-6-16C*	3/4"-16 UNF	1"-11-1/2 NPT	2.50	63.50	1.75	44.45	10,000	690
6Y02-9-2C	1-1/8"-12 UNF	1/8"-27 NPT	2.37	60.20	1.37	34.80	15,000	1,030
6Y02-9-4C	1-1/8"-12 UNF	1/4"-18 NPT	2.37	60.20	1.37	34.80	15,000	1,030
6Y02-9-6C	1-1/8"-12 UNF	3/8"-18 NPT	2.37	60.20	1.37	34.80	15,000	1,030
6Y02-9-8C	1-1/8"-12 UNF	1/2"-14 NPT	2.37	60.20	1.37	34.80	15,000	1,030
6Y02-9-12C	1-1/8"-12 UNF	3/4"-14 NPT	2.37	60.20	1.37	34.80	10,000	690
6Y02-9-16C*	1-1/8"-12 UNF	1"-11-1/2 NPT	2.62	66.55	2.00	50.80	10,000	690

\*Non-standard part - may require longer lead time



### WARNING

This product can expose you to chemicals including Lead, which is known to the State of California to cause cancer and birth defects or other reproductive harm. For more information go to [www.P65Warnings.ca.gov](http://www.P65Warnings.ca.gov).

# NPT Adapters

## 6Y01 — Female High Pressure x Male NPT

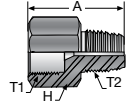

Part Number	T1 Thread Size	T2 Thread Size	A Overall Length		H Hex		Maximum Working Pressure	
			inch	mm	inch	mm	psi	bar
#								
6Y01-4-2C	9/16"-18 UNF	1/8"-27 NPT	1.25	31.75	0.75	19.05	15,000	1,030
6Y01-4-4C	9/16"-18 UNF	1/4"-18 NPT	1.37	34.80	0.75	19.05	15,000	1,030
6Y01-4-6C	9/16"-18 UNF	3/8"-18 NPT	1.37	34.80	0.75	19.05	15,000	1,030
6Y01-4-8C	9/16"-18 UNF	1/2"-14 NPT	1.75	44.45	1.00	25.40	15,000	1,030
6Y01-4-12C	9/16"-18 UNF	3/4"-14 NPT	1.75	44.45	1.37	34.80	10,000	690
6Y01-4-16C	9/16"-18 UNF	1"-11-1/2 NPT	1.62	41.15	1.37	34.80	10,000	690
6Y01-6-1C	3/4"-16 UNF	1/16"-27 NPT	1.63	41.40	1.00	25.40	15,000	1,030
6Y01-6-2C*	3/4"-16 UNF	1/8"-27 NPT	1.50	38.10	1.00	25.40	15,000	1,030
6Y01-6-4C	3/4"-16 UNF	1/4"-18 NPT	1.62	41.15	1.00	25.40	15,000	1,030
6Y01-6-6C	3/4"-16 UNF	3/8"-18 NPT	1.62	41.15	1.00	25.40	15,000	1,030
6Y01-6-8C	3/4"-16 UNF	1/2"-14 NPT	1.75	44.45	1.00	25.40	15,000	1,030
6Y01-6-12C*	3/4"-16 UNF	3/4"-14 NPT	1.87	47.50	1.37	34.80	10,000	690
6Y01-6-16C	3/4"-16 UNF	1"-11-1/2 NPT	1.87	47.50	1.37	34.80	10,000	690
6Y01-9-2C*	1-1/8"-12 UNF	1/8"-27 NPT	1.50	38.10	1.37	34.80	15,000	1,030
6Y01-9-4C	1-1/8"-12 UNF	1/4"-18 NPT	1.62	41.15	1.27	32.26	15,000	1,030
6Y01-9-6C	1-1/8"-12 UNF	3/8"-18 NPT	1.75	44.45	1.37	34.80	15,000	1,030
6Y01-9-8C	1-1/8"-12 UNF	1/2"-14 NPT	1.87	47.50	1.37	34.80	15,000	1,030
6Y01-9-12C	1-1/8"-12 UNF	3/4"-14 NPT	1.87	47.50	1.37	34.80	10,000	690
6Y01-9-16C	1-1/8"-12 UNF	1"-11-1/2 NPT	2.00	50.80	1.37	34.80	10,000	690

\*Non-standard part - may require longer lead time



**WARNING**

This product can expose you to chemicals including Lead, which is known to the State of California to cause cancer and birth defects or other reproductive harm.

For more information go to [www.P65Warnings.ca.gov](http://www.P65Warnings.ca.gov).

# NPT Adapters

## Y601 — Male High Pressure x Male NPT

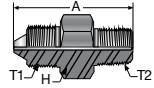

Part Number	T1 Thread Size	T2 Thread Size	A Overall Length		H Hex		Maximum Working Pressure	
			inch	mm	inch	mm	psi	bar
#								
Y601-4-2C	9/16"-18 UNF	1/8"-27 NPT	1.87	47.50	0.62	15.75	15,000	1,030
Y601-4-4C	9/16"-18 UNF	1/4"-18 NPT	2.06	52.32	0.75	19.05	15,000	1,030
Y601-4-6C	9/16"-18 UNF	3/8"-18 NPT	2.00	50.80	0.75	19.05	15,000	1,030
Y601-4-8C	9/16"-18 UNF	1/2"-14 NPT	2.12	53.85	0.87	22.10	15,000	1,030
Y601-4-12C	9/16"-18 UNF	3/4"-14 NPT	2.25	57.15	1.12	28.45	10,000	690
Y601-6-4C	3/4"-16 UNF	1/4"-18 NPT	2.12	53.85	0.87	22.10	15,000	1,030
Y601-6-6C	3/4"-16 UNF	3/8"-18 NPT	2.12	53.85	0.87	22.10	15,000	1,030
Y601-6-8C	3/4"-16 UNF	1/2"-14 NPT	2.28	57.91	0.875	22.23	15,000	1,030
Y601-9-4C	1-1/8"-12 UNF	1/4"-18 NPT	2.37	60.20	1.12	28.45	15,000	1,030
Y601-9-6C	1-1/8"-12 UNF	3/8"-18 NPT	2.37	60.20	1.12	28.45	15,000	1,030
Y601-9-8C	1-1/8"-12 UNF	1/2"-14 NPT	2.50	63.50	1.12	28.45	15,000	1,030
Y601-9-12C	1-1/8"-12 UNF	3/4"-14 NPT	2.62	66.55	1.12	28.45	10,000	690
Y601-9-16C	1-1/8"-12 UNF	1"-11-1/2 NPT	2.75	69.85	1.37	34.80	10,000	690



### WARNING

This product can expose you to chemicals including Lead, which is known to the State of California to cause cancer and birth defects or other reproductive harm. For more information go to [www.P65Warnings.ca.gov](http://www.P65Warnings.ca.gov).

# NPT Adapters

## 02Y6 — Female NPT x Male High Pressure

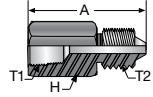

Part Number	T1 Thread Size	T2 Thread Size	A Overall Length		H Hex		Maximum Working Pressure	
			inch	mm	inch	mm	psi	bar
#								
02Y6-1-6C	1/16"-27 NPT	3/4"-16 UNF	1.75	44.45	0.75	19.05	15,000	1,030
02Y6-2-4C	1/8"-27 NPT	9/16"-18 UNF	1.62	41.15	0.75	19.05	15,000	1,030
02Y6-2-6C	1/8"-27 NPT	3/4"-16 UNF	1.62	41.15	0.75	19.05	15,000	1,030
02Y6-2-9C	1/8"-27 NPT	1-1/8"-12 UNF	2.12	53.85	1.12	28.45	15,000	1,030
02Y6-4-4C	1/4"-18 NPT	9/16"-18 UNF	1.75	44.45	0.75	19.05	15,000	1,030
02Y6-4-6C	1/4"-18 NPT	3/4"-16 UNF	1.75	44.45	0.75	19.05	15,000	1,030
02Y6-4-9C	1/4"-18 NPT	1-1/8"-12 UNF	2.12	53.85	1.12	28.45	15,000	1,030
02Y6-6-4C	3/8"-18 NPT	9/16"-18 UNF	1.75	44.45	1.00	25.40	15,000	1,030
02Y6-6-6C	3/8"-18 NPT	3/4"-16 UNF	1.75	44.45	1.00	25.40	15,000	1,030
02Y6-6-9C	3/8"-18 NPT	1-1/8"-12 UNF	2.12	53.85	1.12	28.45	15,000	1,030
02Y6-8-4C	1/2"-14 NPT	9/16"-18 UNF	2.12	53.85	1.12	28.45	15,000	1,030
02Y6-8-6C	1/2"-14 NPT	3/4"-16 UNF	2.12	53.85	1.12	28.45	15,000	1,030
02Y6-8-9C	1/2"-14 NPT	1-1/8"-12 UNF	2.12	53.85	1.12	28.45	15,000	1,030
02Y6-12-6C	3/4"-14 NPT	3/4"-16 UNF	1.50	38.10	1.62	41.15	10,000	690
02Y6-12-9C	3/4"-14 NPT	1-1/8"-12 UNF	2.25	57.15	1.37	34.80	10,000	690
02Y6-16-9C	1"-11-1/2 NPT	1-1/8"-12 UNF	2.00	50.80	2.75	69.85	10,000	690



**WARNING**

This product can expose you to chemicals including Lead, which is known to the State of California to cause cancer and birth defects or other reproductive harm. For more information go to [www.P65Warnings.ca.gov](http://www.P65Warnings.ca.gov).

# NPT Adapters

## K0203— Female NPT x Male JIC

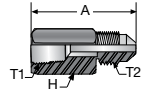

Part Number	T1 Thread Size	T2 Thread Size	A Overall Length		H Hex		Maximum Working Pressure	
			inch	mm	inch	mm	psi	bar
#								
10K0203-4-6C	1/4"-18 NPT	9/16"-18 UNF	1.68	42.67	0.875	22.23	10,000	690
10K0203-4-8C	1/4"-18 NPT	3/4"-16 UNF	1.79	45.47	0.875	22.23	10,000	690
10K0203-6-4C	3/8"-18 NPT	7/16"-20 UNF	1.76	44.70	1.00	25.40	10,000	690
10K0203-6-6C	3/8"-18 NPT	9/16"-18 UNF	1.68	42.67	1.00	25.40	10,000	690
10K0203-6-8C	3/8"-18 NPT	3/4"-16 UNF	1.88	47.75	1.00	25.40	10,000	690
10K0203-8-4C	1/2"-14 NPT	7/16"-20 UNF	2.05	52.07	1.25	31.75	10,000	690
10K0203-8-6C	1/2"-14 NPT	9/16"-18 UNF	1.93	49.02	1.25	31.75	10,000	690
10K0203-8-8C	1/2"-14 NPT	3/4"-16 UNF	2.04	51.82	1.25	31.75	10,000	690
10K0203-16-16C	1"-11-1/2 NPT	1-5/16"-12 UN	2.68	68.07	2.00	50.80	10,000	690

## 01D9 — Male NPT x Male BSP

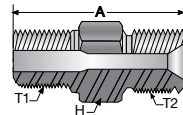

Part Number	T1 Thread Size	T2 Thread Size	A Overall Length		H Hex		Maximum Working Pressure	
			inch	mm	inch	mm	psi	bar
#								
01D9-4-6C	1/4"-18 NPT	G3/8-19	1.52	38.60	0.875	22.23	15,000	1,030
01D9-6-6C	3/8"-18 NPT	G3/8-19	1.57	39.88	0.875	22.23	15,000	1,030
01D9-8-6C	1/2"-14 NPT	G3/8-19	1.86	47.24	0.875	22.23	15,000	1,030
01D9-8-8C	1/2"-14 NPT	G1/2-14	1.98	50.29	1.000	25.40	15,000	1,030



### WARNING

This product can expose you to chemicals including Lead, which is known to the State of California to cause cancer and birth defects or other reproductive harm. For more information go to [www.P65Warnings.ca.gov](http://www.P65Warnings.ca.gov).

# NPT Adapters

## 02D9 — Female NPT x Male BSP

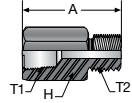

Part Number	T1 Thread Size	T2 Thread Size	A Overall Length		H Hex		Maximum Working Pressure	
			inch	mm	inch	mm	psi	bar
#								
02D9-8-8C	1/2"-14 NPT	G1/2-14	2.10	53.34	1.25	31.75	15,000	1,030

## KL02 — NPT Elbow 90° Elbow

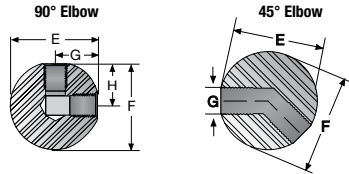

Part Number	Thread Size	Thick-ness	E		F		G		H		Max. Working Pressure	
			inch	mm	inch	mm	inch	mm	inch	mm	psi	bar
#												
10KL02-12C	3/4"-14 NPT	2.05	1.85	46.99	1.85	46.99	1.35	34.29	1.35	34.29	10,000	690
10KL02-16C	1"-11-1/2 NPT	2.50	3.83	97.28	3.83	97.28	1.82	46.23	1.82	46.23	10,000	690
15KL02-4C	1/4"-18 NPT	1.15	1.70	43.18	1.70	43.18	0.80	20.32	0.80	20.32	15,000	1,030
15KL02-6C	3/8"-18 NPT	1.38	1.90	48.26	1.90	48.26	0.90	22.86	0.90	22.86	15,000	1,030
15KL02-8C	1/2"-14 NPT	1.63	2.15	54.61	2.15	54.61	1.03	26.16	1.03	26.16	15,000	1,030

## 45° Elbow

			inch	mm	inch	mm	inch	mm	inch	mm	psi	bar
15KL02-4C-45	1/4"-18 NPT	1.15	1.68	42.67	1.68	42.67	0.7	17.78	—	—	15,000	1,030
15KL02-6C-45	3/8"-18 NPT	1.38	1.89	48.01	1.89	48.01	0.91	23.11	—	—	15,000	1,030
15KL02-8C-45	1/2"-14 NPT	1.63	2.15	54.61	2.15	54.61	0.94	23.88	—	—	15,000	1,030
15KL02-12C-45	3/4"-14 NPT	2.00	2.88	73.15	2.88	73.15	1.2	30.48	—	—	10,000	690



**WARNING**

This product can expose you to chemicals including Lead, which is known to the State of California to cause cancer and birth defects or other reproductive harm. For more information go to [www.P65Warnings.ca.gov](http://www.P65Warnings.ca.gov).

# NPT Adapters

## KT02 — NPT Tee

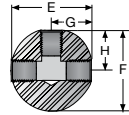

Part Number	Thread Size	Thick-ness	E		F		G		H		Max. Working Pressure	
			inch	mm	inch	mm	inch	mm	inch	mm	psi	bar
#												
10KT02-12C	3/4"-14 NPT	2.05	2.70	68.58	1.85	46.99	1.35	34.29	2.05	52.07	10,000	690
10KT02-16C	1"-11-1/2 NPT	2.50	3.63	92.20	3.83	97.28	1.82	46.23	2.5	63.50	10,000	690
15KT02-4C	1/4"-18 NPT	1.15	1.60	40.64	1.70	43.18	0.80	20.32	1.15	29.21	15,000	1,030
15KT02-6C	3/8"-18 NPT	1.38	1.80	45.72	1.90	48.26	0.90	22.86	1.38	35.05	15,000	1,030
15KT02-8C	1/2"-14 NPT	1.63	2.05	52.07	2.15	54.61	1.03	26.16	1.63	41.40	15,000	1,030

## KX02 — NPT Cross

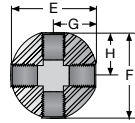

Part Number	Thread Size	Thick-ness	E		F		G		H		Max. Working Pressure	
			inch	mm	inch	mm	inch	mm	inch	mm	psi	bar
#												
10KX02-12C	3/4"-14 NPT	2.05	2.70	68.58	2.70	68.58	1.35	34.29	1.35	34.29	10,000	690
10KX02-16C	1"-11-1/2 NPT	2.50	3.63	92.20	3.63	92.20	1.82	46.23	1.82	46.23	10,000	690
15KX02-4C	1/4"-18 NPT	1.15	1.60	40.64	1.60	40.64	0.8	20.32	0.8	20.32	15,000	1,030
15KX02-6C	3/8"-18 NPT	1.38	1.80	45.72	1.80	45.72	0.9	22.86	0.9	22.86	15,000	1,030
15KX02-8C	1/2"-14 NPT	1.63	2.05	52.07	2.05	52.07	1.03	26.16	1.03	26.16	15,000	1,030





### WARNING

This product can expose you to chemicals including Lead, which is known to the State of California to cause cancer and birth defects or other reproductive harm.

For more information go to [www.P65Warnings.ca.gov](http://www.P65Warnings.ca.gov).



# NPT Adapters

## NPT Caps

Part Number	Thread Size	Overall Length		Hex Size		Max. Working Pressure	
		inch	mm	inch	mm	psi	bar
#							
15K02-2C-CAP	1/8"-27 NPT	0.90	22.86	0.75	19.05	15,000	1,030
15K02-4C-CAP	1/4"-18 NPT	1.16	29.46	0.875	22.23	15,000	1,030
15K02-6C-CAP	3/8"-18 NPT	1.25	31.75	1.00	25.40	15,000	1,030
15K02-8C-CAP	1/2"-14 NPT	1.43	36.32	1.25	31.75	15,000	1,030
10K02-12C-CAP	3/4"-14 NPT	1.5	38.10	1.50	38.10	10,000	690



## NPT Plugs

Part Number	Thread Size	Overall Length		Hex Size		Max. Working Pressure	
		inch	mm	inch	mm	psi	bar
#							
10KP01-12C	3/4"-14 NPT	1.45	36.83	1.125	28.58	10,000	690
10KP01-16C	1"-11-1/2 NPT	1.81	45.97	1.375	34.93	10,000	690
15KP01-1C	1/16"-27 NPT	0.68	17.27	0.375	9.53	15,000	1,030
15KP01-2C	1/8"-27 NPT	0.75	19.05	0.50	12.70	15,000	1,030



**WARNING**

This product can expose you to chemicals including Lead, which is known to the State of California to cause cancer and birth defects or other reproductive harm. For more information go to [www.P65Warnings.ca.gov](http://www.P65Warnings.ca.gov).



# JIC Adapters



Parker Parflex offers a wide range of high quality stainless steel high pressure JIC adapters from **10,000 psi to 15,000 psi** operating pressure. Sizes range from 1/4" to 1".

## Advantages:

- All adapters are rated to a minimum operating pressure of 10,000 psi
- Meets SAE J514 configuration on flare end
- Compact envelope size for ease of installation

## Sizes:

- 04 7/16"-20 UNF
- 06 9/16"-18 UNF
- 08 3/4"-16 UNF
- 10 7/8"-14 UNF
- 12 1-1/16"-12 UN
- 16 1-5/16"-12 UN



## WARNING

This product can expose you to chemicals including Lead, which is known to the State of California to cause cancer and birth defects or other reproductive harm. For more information go to [www.P65Warnings.ca.gov](http://www.P65Warnings.ca.gov).

# JIC Adapters

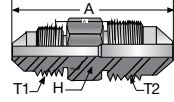

## K0303— Male JIC x Male JIC

Part Number	T1 Thread Size	T2 Thread Size	A Overall Length		H Hex		Maximum Working Pressure	
			inch	mm	inch	mm	psi	bar
#								
10K0303-4-4C	7/16"-20 UNF	7/16"-20 UNF	1.50	38.10	0.625	15.88	10,000	690
10K0303-4-6C	7/16"-20 UNF	9/16"-18 UNF	1.50	38.10	0.625	15.88	10,000	690
10K0303-4-8C	7/16"-20 UNF	3/4"-16 UNF	1.72	43.69	0.875	22.23	10,000	690
10K0303-6-8C	9/16"-18 UNF	3/4"-16 UNF	1.73	43.94	0.875	22.23	10,000	690

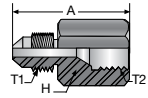

## K0306— Male JIC x Female JIC

Part Number	T1 Thread Size	T2 Thread Size	A Overall Length		H Hex		Maximum Working Pressure	
			inch	mm	inch	mm	psi	bar
#								
10K0306-4-4C	7/16"-20 UNF	7/16"-20 UNF	1.43	36.32	0.75	19.05	10,000	690
10K0306-4-6C	7/16"-20 UNF	9/16"-18 UNF	1.55	39.37	0.875	22.23	10,000	690
10K0306-4-8C	7/16"-20 UNF	3/4"-16 UNF	1.60	40.64	1.00	25.40	10,000	690
10K0306-6-6C	9/16"-18 UNF	9/16"-18 UNF	1.55	39.37	0.875	22.23	10,000	690
10K0306-8-6C	3/4"-16 UNF	9/16"-18 UNF	1.55	39.37	0.875	22.23	10,000	690

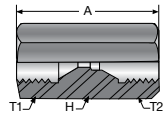

## K0606— Female JIC x Female JIC

Part Number	T1 Thread Size	T2 Thread Size	A Overall Length		H Hex		Maximum Working Pressure	
			inch	mm	inch	mm	psi	bar
#								
10K0606-4-4C	7/16"-20 UNF	7/16"-20 UNF	1.35	34.29	0.75	19.05	10,000	690
10K0606-4-6C	7/16"-20 UNF	9/16"-18 UNF	1.50	38.10	0.875	22.23	10,000	690
10K0606-6-6C	9/16"-18 UNF	9/16"-18 UNF	1.40	35.56	0.875	22.23	10,000	690



**WARNING**

This product can expose you to chemicals including Lead, which is known to the State of California to cause cancer and birth defects or other reproductive harm. For more information go to [www.P65Warnings.ca.gov](http://www.P65Warnings.ca.gov).

# JIC Adapters

## YA03 — Male Type “M” x Male JIC

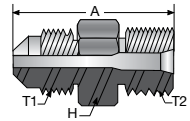

Part Number	T1 Thread Size	T2 Thread Size	A Overall Length		H Hex		Maximum Working Pressure	
			inch	mm	inch	mm	psi	bar
#								
YA03-11-6C	1"-12 UNF	9/16"-18 UNF	1.69	42.93	1.00	34.93	10,000	690
YA03-16-8C	1-5/16" -12 UN	3/4"-16 UNF	1.79	45.47	1.375	34.93	10,000	690
YA03-16-12C	1-5/16" -12 UN	1-1/16"-12 UN	2.00	50.80	1.375	34.93	10,000	690

## Y503 — Male Medium Pressure x Male JIC

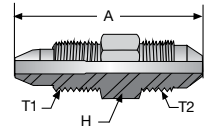

Part Number	T1 Thread Size	T2 Thread Size	A Overall Length		H Hex		Maximum Working Pressure	
			inch	mm	inch	mm	psi	bar
#								
Y503-4-8C	7/16"-20 UNF	3/4"-16 UNF	1.74	44.20	0.875	22.23	10,000	690
Y503-9-10C	13/16"-16 UN	7/8"-14 UNF	2.38	60.45	1.000	25.40	10,000	690
Y503-9-12C	13/16"-16 UN	1-1/16"-12 UN	2.47	62.74	1.125	28.58	10,000	690
Y503-9-16C	13/16"-16 UN	1-5/16"-12 UN	2.55	64.77	1.375	34.93	10,000	690
Y503-12-6C	3/4"-14 NPSM	9/16"-18 UNF	2.25	57.15	1.125	28.58	10,000	690
Y503-12-8C	3/4"-14 NPSM	3/4"-16 UNF	2.35	59.69	1.125	28.58	10,000	690
Y503-12-12C	3/4"-14 NPSM	1-1/16"-12 UN	2.66	67.56	1.125	28.58	10,000	690
Y503-16-12C	1"-14 UNF LH	1-1/16"-12 UN	4.02	102.11	1.125	28.58	10,000	690
Y503-16-16C	1"-14 UNF LH	1-5/16"-12 UN	4.07	103.38	1.375	34.93	10,000	690



### WARNING

This product can expose you to chemicals including Lead, which is known to the State of California to cause cancer and birth defects or other reproductive harm. For more information go to [www.P65Warnings.ca.gov](http://www.P65Warnings.ca.gov).

# JIC Adapters

## Y603 — Male High Pressure x Male JIC

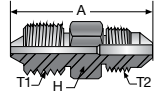

Part Number	T1 Thread Size	T2 Thread Size	A Overall Length		H Hex		Maximum Working Pressure	
			inch	mm	inch	mm	psi	bar
#								
Y603-4-4C	9/16"-18 UNF	7/16"-20 UNF	1.61	40.89	0.625	15.88	10,000	690
Y603-4-6C	9/16"-18 UNF	9/16"-18 UNF	1.61	40.89	0.625	15.88	10,000	690
Y603-4-8C	9/16"-18 UNF	3/4"-16 UNF	1.81	45.97	0.875	22.23	10,000	690
Y603-6-4C	3/4"-16 UNF	7/16"-20 UNF	1.84	46.74	0.750	19.05	10,000	690
Y603-6-6C	3/4"-16 UNF	9/16"-18 UNF	1.94	49.28	0.750	19.05	10,000	690
Y603-6-8C	3/4"-16 UNF	3/4"-16 UNF	2.04	51.82	0.875	22.23	10,000	690
Y603-9-6C	1-1/8"-12 UNF	9/16"-18 UNF	2.09	53.09	1.125	28.58	10,000	690
Y603-9-8C	1-1/8"-12 UNF	3/4"-16 UNF	2.19	55.63	1.125	28.58	10,000	690

## JIC Caps

Part Number	Thread Size	Overall Length		Hex Size		Maximum Working Pressure	
		inch	mm	inch	mm	psi	bar
#							
10K06-4C-CAP	7/16"-20 UNF	0.83	21.08	0.75	19.05	10,000	690
10K06-6C-CAP	9/16"-18 UNF	0.93	23.62	0.875	22.23	10,000	690
10K06-8C-CAP	3/4"-16 UNF	1.04	26.42	1.00	25.40	10,000	690
10K06-10C-CAP	7/8"-14 UNF	1.16	29.46	1.25	31.75	10,000	690
10K06-12C-CAP	1-1/16"-12 UN	1.31	33.27	1.50	38.10	10,000	690

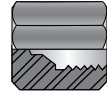

## JIC Plugs

Part Number	Thread Size	Overall Length		Hex Size		Maximum Working Pressure	
		inch	mm	inch	mm	psi	bar
#							
10KP03-4C	7/16"-20 UNF	0.81	20.57	0.5	12.70	10,000	690
10KP03-6C	9/16"-18 UNF	0.85	21.59	0.625	15.88	10,000	690
10KP03-8C	3/4"-16 UNF	0.95	24.13	0.812	20.62	10,000	690
10KP03-10C	7/8"-14 UNF	1.11	28.19	0.937	23.80	10,000	690
10KP03-12C	1-1/16"-12 UNF	1.29	32.80	0.750	19.05	10,000	690
10KP03-16C	1-5/16"-12 UN	1.34	34.04	1.375	34.93	10,000	690

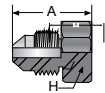

### WARNING

This product can expose you to chemicals including Lead, which is known to the State of California to cause cancer and birth defects or other reproductive harm. For more information go to [www.P65Warnings.ca.gov](http://www.P65Warnings.ca.gov).

# Valves

Medium Pressure — up to 20K psi

High Pressure — up to 60K psi



Developed to assure safe and easy plumbing through 60,000 psi, these needle valves are engineered to the highest standards of repeatable quality. The medium pressure valves are designed with a compact cone-and-threaded connection which permits the larger bore sizes and increased flow rates common in this pressure class. The high pressure valves also use a cone-and-threaded connection which accommodates the high pressures common in these applications.

Non-rotating tip stems are standard for on-off service and ensure long life of valve seats.

Materials include high tensile Type 316 stainless steel bodies and hardened 17-4PH stainless steel lower section stems.

Standard packing is TFE with optional Viton®, BUNA-N and Grafoil available as non-standard.

Two-way straight valves are standard with five additional patterns available to satisfy a wide variety of requirements.

## Features:

- Non-rotating stem tips
- Packing below stem threads
- Type 316 as high tensile bodies
- Positive gland lock device
- No stem adjustment needed
- Black T-handles are standard; choice of 4 colors available for special order
- Tube sizes:
  - Medium pressure — 1/4" through 1"
  - High pressure — 1/4" through 9/16"



### WARNING

This product can expose you to chemicals including Lead, which is known to the State of California to cause cancer and birth defects or other reproductive harm.

For more information go to [www.P65Warnings.ca.gov](http://www.P65Warnings.ca.gov).

# Medium Pressure Valves-(20K psi)

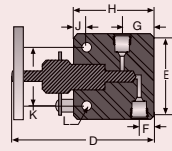

## SV5Y — Two-way Straight Valves

Part Number	Connection Size	Orifice	Thick-ness	D	E	F	G	H	J	K	L	Max. Working Pressure	
#				inch	inch	inch	inch	inch	inch	inch	inch	psi	bar
SV5Y-4C-20*	1/4" MP	0.51	1.37	7.00	3.00	0.75	1.50	3.75	0.62	1.75	0.43	20,000	1,380
SV5Y-6C-20	3/8" MP	0.68	1.75	8.42	4.12	0.87	1.81	4.62	1.12	2.50	0.56	20,000	1,380
SV5Y-9C-20	9/16" MP	0.10	0.75	4.37	2.00	0.37	0.81	2.00	0.37	1.25	0.21	20,000	1,380
SV5Y-12C-20*	3/4" MP	0.20	0.75	4.37	2.00	0.37	0.81	2.00	0.37	1.25	0.21	20,000	1,380
SV5Y-16C-20*	1" MP	0.31	1.00	6.12	2.50	0.50	1.12	2.87	0.50	1.37	0.34	20,000	1,380

\*Non-standard part - may require longer lead time

## AV5Y — Two-way Angle Valves

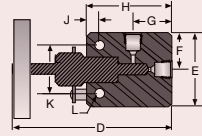

Part Number	Connection Size	Orifice	Thick-ness	D	E	F	G	H	J	K	L	Max. Working Pressure	
#				inch	inch	inch	inch	inch	inch	inch	inch	psi	bar
AV5Y-4C-20	1/4" MP	0.10	0.75	4.81	2.00	1.00	1.25	2.43	0.37	1.25	0.21	20,000	1,380
AV5Y-6C-20	3/8" MP	0.10	0.75	4.81	2.00	1.00	1.25	2.43	0.37	1.25	0.21	20,000	1,380
AV5Y-9C-20	9/16" MP	0.51	1.00	6.62	2.50	1.25	1.62	3.37	0.50	1.37	0.34	20,000	1,380
AV5Y-12C-20	3/4" MP	0.51	1.37	7.50	3.00	1.50	2.00	4.25	0.62	1.75	0.43	20,000	1,380
AV5Y-16C-20*	1" MP	0.68	1.75	9.37	4.12	2.06	2.56	5.43	1.12	2.50	0.56	20,000	1,380

\*Non-standard part - may require longer lead time



**WARNING**

This product can expose you to chemicals including Lead, which is known to the State of California to cause cancer and birth defects or other reproductive harm. For more information go to [www.P65Warnings.ca.gov](http://www.P65Warnings.ca.gov).

# Medium Pressure Valves-(20K psi)

## TV25Y — Three-way Valves, Two Pressure Connections

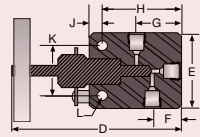

Part Number	Connection Size	Orifice	Thickness	D	E	F	G	H	J	K	L	Max. Working Pressure	
#												psi	bar
TV25Y-4C-20*	1/4" MP	0.10	0.75	5.00	2.00	1.00	1.43	2.62	0.37	1.25	0.21	20,000	1,380
TV25Y-6C-20*	3/8" MP	0.20	0.75	5.00	2.00	1.00	1.43	2.62	0.37	1.25	0.21	20,000	1,380
TV25Y-9C-20	9/16" MP	0.31	1.00	6.87	2.50	1.25	1.87	3.62	0.50	1.37	0.34	20,000	1,380
TV25Y-12C-20*	3/4" MP	0.51	1.37	7.87	3.00	2.62	2.37	4.67	0.62	1.75	0.43	20,000	1,380
TV25Y-16C-20*	1" MP	0.68	1.75	9.75	4.12	2.12	3.06	5.87	1.12	2.50	0.56	20,000	1,380

\*Non-standard part - may require longer lead time

## TV15Y — Three-way Valves, One Pressure Connection

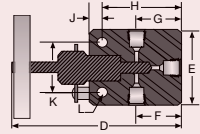

Part Number	Connection Size	Orifice	Thickness	D	E	F	G	H	J	K	L	Max. Working Pressure	
#												psi	bar
TV15Y-4C-20*	1/4" MP	0.10	0.75	4.81	2.00	1.25	1.25	2.43	0.37	1.25	0.21	20,000	1,380
TV15Y-6C-20*	3/8" MP	0.20	0.75	4.81	2.00	1.25	1.25	2.43	0.37	1.25	0.21	20,000	1,380
TV15Y-9C-20*	9/16" MP	0.31	1.00	6.62	2.50	1.62	1.62	3.37	0.50	1.37	0.34	20,000	1,380
TV15Y-12C-20*	3/4" MP	0.51	1.37	7.50	3.00	2.00	2.00	4.25	0.62	1.75	0.43	20,000	1,380
TV15Y-16C-20*	1" MP	0.68	1.75	9.37	4.12	2.62	2.62	5.43	1.12	2.50	0.56	20,000	1,380

\*Non-standard part - may require longer lead time

## CV5Y — Medium Pressure Ball Check Valves

Part Number	Connection Size	A Overall Length		Hex Size		Max. Working Pressure	
#		inch	mm	inch	mm	psi	bar
CV5Y-4C-20*	1/4" MP	3.75	95.25	1.00	25.40	20,000	1,380
CV5Y-6C-20	3/8" MP	3.75	95.25	1.00	25.40	20,000	1,380
CV5Y-9C-20	9/16" MP	0.35	8.89	1.37	34.80	20,000	1,380

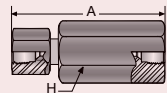

\*Non-standard part - may require longer lead time



### WARNING

This product can expose you to chemicals including Lead, which is known to the State of California to cause cancer and birth defects or other reproductive harm. For more information go to [www.P65Warnings.ca.gov](http://www.P65Warnings.ca.gov).

Hose  
 A  
 Fittings  
 B  
 Adapters & Valves  
 C  
 Quick Couplings  
 D  
 Accessories  
 E  
 General Technical  
 F

# High Pressure Valves-(30K/60K psi)

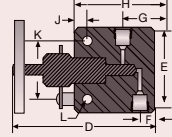

## SV6Y — Two-way Straight Valves

Part Number	Connection Size	Orifice	Thick-ness	D	E	F	G	H	J	K	L	Max. Working Pressure		
#														
				inch	inch	inch	inch	inch	inch	inch	inch	psi	bar	
SV6Y-4C-30	1/4" HP	0.09	1.00	5.18	2.00	0.62	1.00	2.43	0.50	1.37	0.21	30,000	2,070	
SV6Y-6C-30	3/8" HP	0.12	1.00	5.18	2.00	0.62	1.00	2.43	0.50	1.37	0.21	30,000	2,070	
SV6Y-9C-30	9/16" HP	0.12	1.50	5.62	2.62	1.00	1.43	2.87	0.50	1.37	0.21	30,000	2,070	
SV6Y-4C-60	1/4" HP	0.06	1.00	5.18	2.00	0.62	1.00	2.43	0.50	1.37	0.21	60,000	4,140	
SV6Y-6C-60	3/8" HP	0.06	1.00	5.18	2.00	0.62	1.00	2.43	0.50	1.37	0.21	60,000	4,140	
SV6Y-9C-60	9/16" HP	0.06	1.50	5.62	2.62	1.00	1.43	2.87	0.50	1.37	0.21	60,000	4,140	

## AV6Y — Two-way Angle Valves

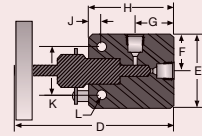

Part Number	Connection Size	Orifice	Thick-ness	D	E	F	G	H	J	K	L	Max. Working Pressure		
#														
				inch	inch	inch	inch	inch	inch	inch	inch	psi	bar	
AV6Y-4C-30	1/4" HP	0.09	1.00	5.18	2.00	1.00	1.00	2.43	0.50	1.37	0.21	30,000	2,070	
AV6Y-6C-30	3/8" HP	0.12	1.00	5.56	2.00	1.00	1.37	2.81	0.50	1.37	0.21	30,000	2,070	
AV6Y-9C-30	9/16" HP	0.12	1.50	5.62	2.62	1.31	1.43	2.87	0.50	1.37	0.21	30,000	2,070	
AV6Y-4C-60	1/4" HP	0.06	1.00	5.18	2.00	1.00	1.00	2.43	0.50	1.37	0.21	60,000	4,140	
AV6Y-6C-60	3/8" HP	0.06	1.00	5.56	2.00	1.00	1.37	2.81	0.50	1.37	0.21	60,000	4,140	
AV6Y-9C-60*	9/16" HP	0.06	1.50	5.62	2.62	1.31	1.43	2.87	0.50	1.37	0.21	60,000	4,140	

\*Non-standard part - may require longer lead time



**WARNING**

This product can expose you to chemicals including Lead, which is known to the State of California to cause cancer and birth defects or other reproductive harm. For more information go to [www.P65Warnings.ca.gov](http://www.P65Warnings.ca.gov).



# High Pressure Valves-(30K/60K psi)

## TV26Y — Three-way Valves, Two Pressure Connections

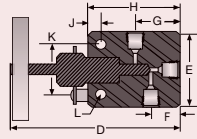

Part Number	Connection Size	Orifice	Thickness	D	E	F	G	H	J	K	L	Max. Working Pressure	
#				inch	inch	inch	inch	inch	inch	inch	inch	psi	bar
TV26Y-4C-30*	1/4" HP	0.09	1.00	5.18	2.00	0.62	1.00	2.43	0.50	1.37	0.21	30,000	2,070
TV26Y-6C-30*	3/8" HP	0.12	1.00	5.56	2.00	1.00	1.37	2.81	0.50	1.37	0.21	30,000	2,070
TV26Y-9C-30*	9/16" HP	0.12	1.50	6.06	2.62	1.43	1.87	3.31	0.50	1.37	0.21	30,000	2,070
TV26Y-4C-60*	1/4" HP	0.06	1.00	5.18	2.00	0.62	1.00	2.43	0.50	1.37	0.21	60,000	4,140
TV26Y-6C-60*	3/8" HP	0.06	1.00	5.56	2.00	1.00	1.37	2.81	0.50	1.37	0.21	60,000	4,140
TV26Y-9C-60*	9/16" HP	0.06	1.50	6.06	2.62	1.43	1.87	2.87	0.50	1.37	0.21	60,000	4,140

\*Non-standard part - may require longer lead time

## TV16Y — Three-way Valves, One Pressure Connection

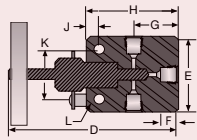

Part Number	Connection Size	Orifice	Thickness	D	E	F	G	H	J	K	L	Max. Working Pressure	
#				inch	inch	inch	inch	inch	inch	inch	inch	psi	bar
TV16Y-4C-30*	1/4" HP	0.09	1.00	5.18	2.00	1.00	1.00	2.43	0.50	1.37	0.21	30,000	2,070
TV16Y-6C-30*	3/8" HP	0.12	1.00	5.56	2.00	2.00	1.43	2.81	0.50	1.37	0.21	30,000	2,070
TV16Y-9C-30*	9/16" HP	0.12	1.50	5.62	2.62	2.18	1.43	2.87	0.50	1.37	0.21	30,000	2,070
TV16Y-4C-60*	1/4" HP	0.06	1.00	5.18	2.00	1.00	1.00	2.43	0.50	1.37	0.21	60,000	4,140
TV16Y-6C-60	3/8" HP	0.06	1.00	5.56	2.00	2.00	1.43	2.81	0.50	1.37	0.21	60,000	4,140
TV16Y-9C-60*	9/16" HP	0.06	1.50	5.62	2.62	2.18	1.43	2.87	0.50	1.37	0.21	60,000	4,140

\*Non-standard part - may require longer lead time



### WARNING

This product can expose you to chemicals including Lead, which is known to the State of California to cause cancer and birth defects or other reproductive harm. For more information go to [www.P65Warnings.ca.gov](http://www.P65Warnings.ca.gov).

# High Pressure Valves

## CV6Y— High Pressure Ball Check Valves

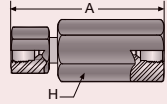

Part Number	Connection Size	A Overall Length		H Hex		Maximum Working Pressure	
		inch	mm	inch	mm	psi	bar
#							
CV6Y-4C-60	1/4" HP	4.18	106.17	1.50	38.10	60,000	4,140
CV6Y-6C-60*	3/8" HP	4.25	107.95	1.50	38.10	60,000	4,140
CV6Y-9C-60	9/16" HP	4.62	117.35	1.56	39.62	60,000	4,140

\*Non-standard part - may require longer lead time

DISCONTINUED



**WARNING**

This product can expose you to chemicals including Lead, which is known to the State of California to cause cancer and birth defects or other reproductive harm. For more information go to [www.P65Warnings.ca.gov](http://www.P65Warnings.ca.gov).

# Quick Couplings

Rogan Series  
C-Series Hydraulic



# Table of Contents

## Introduction

Quick Coupling Nomenclature ..... D-3

## Quick Couplings

**Rogan Series**..... D-5

    HP006 Coupler ..... D-6

    HP006 Nipple without Check Valve..... D-7

    HP006 Nipple with Check Valve ..... D-8

    HP010 Coupler ..... D-9

    HP010 Nipple without Check Valve..... D-10

    HP010 Nipple with Check Valve..... D-11

**C Series** ..... D-12

    115 Coupler ..... D-13

    115 Nipple ..... D-14

    116 Coupler ..... D-15

    116 Nipple ..... C-16

    125 Coupler..... D-17

    125 Nipple ..... D-17

    Quick Coupling Adapters ..... D-18

# Quick Coupling Nomenclature

## Quick Coupling Part Numbers (Rogan Series)

The part number description given to the Rogan Series (Walther Quick Couplings) is as follows:

### Example: HP006-0-NMC

**HP006**-0-NMC – **Thru Hole Size** (HP006 = .24", or 6mm, nominal thru hole diameter)

HP006-**0**-NMC – **Component Type** (0 = Female coupler with check valve)

HP006-0-**NMC** – **Connection Type** (N = NPT)

HP006-0-N**MC** – **Connection Gender** (M = Male)

HP006-0-NMC – **Connection Size** (C = 3/8" NPT)

Thru Hole Size	
HP006	.24", or 6mm, nominal thru hole diameter
HP010	.40", or 10mm, nominal thru hole diameter

Component Type	
0	Female coupler with check valve
1	Male nipple w/o check valve (straight through)
2	Male nipple with check valve

Thread Form					
Connection Type		Connection Gender		Connection Size	
H	High Pressure	M	Male	4	1/4"
L	Medium Pressure	F	Female	6	3/8"
A	Type "M"			9	9/16"
N	NPT			12	3/4"
X	Low Angle Face Seal			16	1"
				B	1/4" NPT
				C	3/8" NPT
				D	1/2" NPT

# Quick Coupling Nomenclature

## Quick Coupling Part Numbers (C Series)

The part number description given to the C Series couplings is as shown below. This description is for couplings only. The part numbers for quick coupling adapters will deviate from this structure.

### Example: C10-116-1202

<b>C10</b> -116-1202 – <b>Part Type</b>	(C10 = Coupling Component)
C10- <b>116</b> -1202 – <b>Series</b>	(116 = Max. Working Pressure of 21,760 psi)
C10-116- <b>1202</b> – <b>Component Type</b>	(1 = Coupler)
C10-116-1 <b>202</b> – <b>Connection</b>	(2 = BSP)
C10-116-120 <b>2</b> – <b>Gender</b>	(0 = Female)
C10-116-1202- <b>2</b> – <b>Size</b>	(2 = 1/4")

Part Type	
C10	Coupling component
C19	Adapter

Series	
115	Working pressure of 14,500 psi (100 MPa)
116	Working pressure of 21,760 psi (150 MPa)
125	Working pressure of 29,000 psi (200 MPa)
950	Adapters only - Working pressures up to 43,500 psi (300 MPa)

Part Type - Couplings only, not applicable to adapters	
1	Coupler
6	Nipple
5	Nipple w/o Check Valve

Thread Form - Couplings only, not applicable to adapters					
Connection Type		Connection Gender		Connection Size	
2	BSP	5	Male	1	1/8"
4	NPT	0	Female	2	1/4"
		2	Female w/ built-in locking device	4	3/8"

# Rogan Series Quick Couplings



Rogan series quick couplings are versatile connecting devices that permit easy and rapid joining of hose assemblies to your system. Each coupling is assembled and pressure tested to at least 5,000 psi above its maximum rated working pressure. Couplings with check-valves can withstand the full working pressure in the disconnected condition. The standard seal material is Nitrile, however, Viton, EPDM and FFKM are also available.

Type	Max. Working Pressure (psi)	Test Pressure (psi)	Nominal Thru Hole Diameter (in)
HP006	30,000	35,000	0.24
HP010	20,000	25,000	0.40

**Note:** The choice of the threaded end form may limit the working pressure and the size of the thru hole in the coupling. Call **polyflex** for additional information.





## WARNING

This product can expose you to chemicals including Lead, which is known to the State of California to cause cancer and birth defects or other reproductive harm. For more information go to [www.P65Warnings.ca.gov](http://www.P65Warnings.ca.gov).

# Rogan Series Quick Couplings

## HP006 Coupler

Part Number	Thread Type	A Overall Length		H Hex		Maximum Working Pressure	
		inch	mm	inch	mm	psi	bar
#							
HP006-0-A9	Type "M" (9/16" - 18)	3.30	83.82	1.19	30.23	30,000	2,070
HP006-0-A12	Type "M" (3/4" - 16)	3.34	84.84	1.19	30.23	30,000	2,070
HP006-0-HM4	1/4" High Pressure Male (9/16" - 18)	3.46	87.88	1.19	30.23	30,000	2,070
HP006-0-HM9	9/16" High Pressure Male (1-1/8" - 12)	3.70	93.98	1.19	30.23	30,000	2,070
HP006-0-LM6	3/8" Medium Pressure Male (9/16" - 18)	3.54	89.92	1.19	30.23	20,000	1,380
HP006-0-NFB	1/4" NPT Female	3.30	83.82	1.19	30.23	15,000	1,030
HP006-0-NFC	3/8" NPT Female	3.30	83.82	1.19	30.23	15,000	1,030
HP006-0-NMB	1/4" NPT Male	3.40	86.36	1.19	30.23	15,000	1,030
HP006-0-NMC	3/8" NPT Male	3.30	83.82	1.19	30.23	15,000	1,030
HP006-0-NMD	1/2" NPT Male	3.45	87.63	1.19	30.23	15,000	1,030
HP006-0-X13	Low Angle Face Seal (9/16" - 18)	3.37	85.60	1.19	30.23	30,000	2,070

Construction: Alloy steel

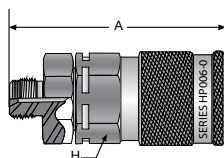

HP006-0-A9  
HP006-0-A12

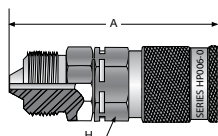

HP006-0-HM4  
HP006-0-HM9

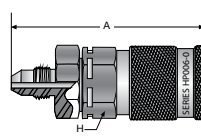

HP006-0-LM6

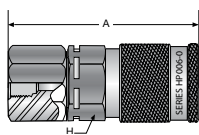

HP006-0-NFB  
HP006-0-NFC

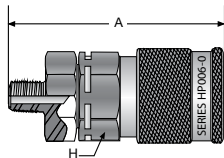

HP006-0-NMB  
HP006-0-NMC  
HP006-0-NMD

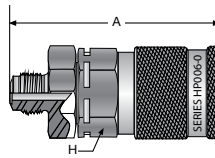

HP006-0-X13





### WARNING

This product can expose you to chemicals including Lead, which is known to the State of California to cause cancer and birth defects or other reproductive harm. For more information go to [www.P65Warnings.ca.gov](http://www.P65Warnings.ca.gov).



# Rogan Series Quick Couplings

## HP006 Nipple w/o Check Valve

Part Number	Thread Type	A Overall Length		H Hex		Maximum Working Pressure	
		inch	mm	inch	mm	psi	bar
#							
HP006-1-A9	Type "M" (9/16" - 18)	1.98	50.29	0.75	19.05	30,000	2,070
HP006-1-A12	Type "M" (3/4" - 16)	2.16	54.86	0.87	22.10	30,000	2,070
HP006-1-HM4	1/4" High Pressure Male (9/16" - 18)	2.25	57.15	0.75	19.05	30,000	2,070
HP006-1-LM6	3/8" Medium Pressure Male (9/16" - 18)	2.33	59.18	0.75	19.05	20,000	1,380
HP006-1-LM9	9/16" Medium Pressure Male (13/16" - 16)	2.57	65.28	1.00	25.40	20,000	1,380
HP006-1-NMB	1/4" NPT Male	2.09	53.09	0.75	19.05	15,000	1,030
HP006-1-NMC	3/8" NPT Male	2.13	54.10	0.75	19.05	15,000	1,030
HP006-1-NMD	1/2" NPT Male	2.31	58.67	1.00	25.40	15,000	1,030
HP006-1-X13	Low Angle Face Seal (9/16" - 18)	2.17	55.12	0.75	19.05	30,000	2,070

Construction: Alloy steel

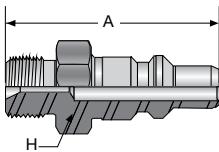

HP006-1-A9  
HP006-1-A12

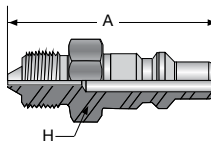

HP006-1-HM4

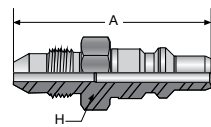

HP006-1-LM6  
HP006-1-LM9

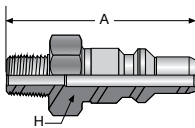

HP006-1-NMB  
HP006-1-NMC  
HP006-1-NMD

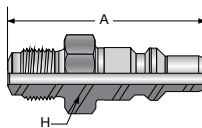

HP006-1-X13





**WARNING**

This product can expose you to chemicals including Lead, which is known to the State of California to cause cancer and birth defects or other reproductive harm. For more information go to [www.P65Warnings.ca.gov](http://www.P65Warnings.ca.gov).

# Rogan Series Quick Couplings

## HP006 Nipple w/ Check Valve

Part Number	Thread Type	A Overall Length		H Hex		Maximum Working Pressure	
		inch	mm	inch	mm	psi	bar
#							
HP006-2-A9	Type "M" [9/16" - 18]	3.28	83.31	1.19	30.23	30,000	2,070
HP006-2-A12	Type "M" [3/4" - 16]	3.30	83.82	1.19	30.23	30,000	2,070
HP006-2-HM4	1/4" High Pressure Male [9/16" - 18]	3.45	87.63	1.19	30.23	30,000	2,070
HP006-2-LM6	3/8" Medium Pressure Male [9/16" - 18]	3.52	89.41	1.19	30.23	20,000	1,380
HP006-2-NFB	1/4" NPT Female	3.26	82.80	1.19	30.23	15,000	1,030
HP006-2-NFC	3/8" NPT Female	3.25	82.55	1.19	30.23	15,000	1,030
HP006-2-NMB	1/4" NPT Male	3.34	84.84	1.19	30.23	15,000	1,030
HP006-2-NMC	3/8" NPT Male	3.34	84.84	1.19	30.23	15,000	1,030
HP006-2-NMD	1/2" NPT Male	3.43	87.12	1.19	30.23	15,000	1,030
HP006-2-X13	Low Angle Face Seal [9/16" - 18]	3.35	85.09	1.19	30.23	30,000	2,070

Construction: Alloy steel

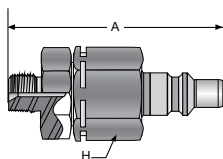

HP006-2-A9  
HP006-2-A12

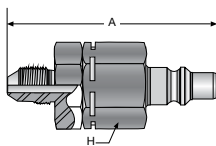

HP006-2-HM4

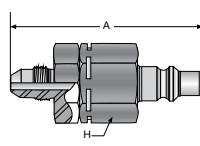

HP006-2-LM6

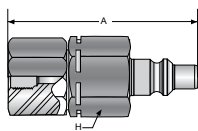

HP006-2-NFB  
HP006-2-NFC

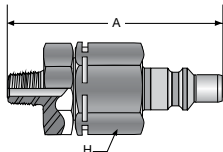

HP006-2-NMB  
HP006-2-NMC  
HP006-2-NMD

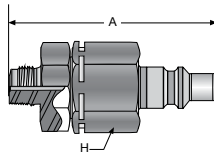

HP006-2-X13





### WARNING

This product can expose you to chemicals including Lead, which is known to the State of California to cause cancer and birth defects or other reproductive harm. For more information go to [www.P65Warnings.ca.gov](http://www.P65Warnings.ca.gov).

# Rogan Series Quick Couplings

## HP010 Coupler

Part Number	Thread Type	A Overall Length		H Hex		Maximum Working Pressure	
		inch	mm	inch	mm	psi	bar
#							
HP010-0-A12	Type "M" (3/4" - 16)	4.00	101.60	1.62	41.15	20,000	1,380
HP010-0-A16	Type "M" (1" - 12)	4.10	104.14	1.62	41.15	20,000	1,380
HP010-0-LM12	3/4" Medium Pressure Male (3/4" - 14)	4.64	117.86	1.62	41.15	20,000	1,380
HP010-0-NFD	1/2" NPT Female	4.27	108.46	1.62	41.15	15,000	1,030
HP010-0-NMD	1/2" NPT Male	4.13	104.90	1.62	41.15	15,000	1,030
HP010-0-X23	Low Angle Face Seal (3/4" - 16)	4.19	106.43	1.62	41.15	20,000	1,380

Construction: Alloy steel

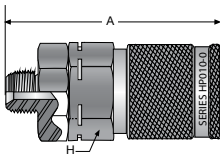

HP010-0-A12  
HP010-0-A16

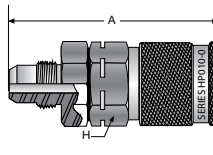

HP010-0-LM12

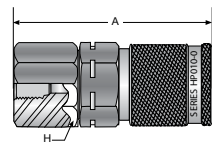

HP010-0-NFD

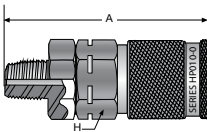

HP010-0-NMD

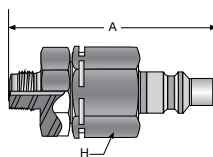

HP010-2-X13





**WARNING**

This product can expose you to chemicals including Lead, which is known to the State of California to cause cancer and birth defects or other reproductive harm. For more information go to [www.P65Warnings.ca.gov](http://www.P65Warnings.ca.gov).

# Rogan Series Quick Couplings

## HP010 Nipple w/o Check Valve

Part Number	Thread Type	A Overall Length		H Hex		Maximum Working Pressure	
		inch	mm	inch	mm	psi	bar
#							
HP010-1-A12	Type "M" (3/4" - 16)	2.40	60.96	1.06	26.92	20,000	1,380
HP010-1-A16	Type "M" (1" - 12)	2.53	64.26	1.18	29.97	20,000	1,380
HP010-1-LM9	9/16" Medium Pressure Male	3.12	79.25	1.18	29.97	20,000	1,380
HP010-1-LM12	3/4" Medium Pressure Male	2.84	72.14	1.06	26.92	20,000	1,380
HP010-1-NMD	1/2" NPT Male	2.52	64.01	1.06	26.92	15,000	1,030
HP010-1-X23	Low Angle Face Seal (3/4" - 16)	2.58	65.53	1.06	26.92	20,000	1,380

Construction: Alloy steel

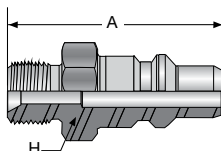

HP010-1-A12  
HP010-1-A16

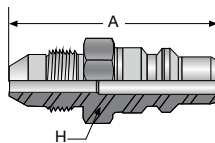

HP010-1-LM9  
HP010-1-LM12

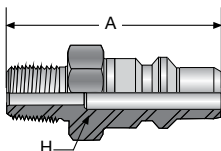

HP010-1-NMD

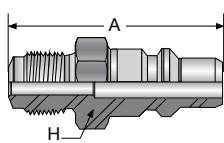

HP010-1-X23





### WARNING

This product can expose you to chemicals including Lead, which is known to the State of California to cause cancer and birth defects or other reproductive harm. For more information go to [www.P65Warnings.ca.gov](http://www.P65Warnings.ca.gov).

# Rogan Series Quick Couplings

## HP010 Nipple w/ Check Valve

Part Number	Thread Type	A Overall Length		H Hex		Maximum Working Pressure	
		inch	mm	inch	mm	psi	bar
#							
HP010-2-A12	Type "M" (3/4" - 16)	4.00	101.60	1.62	41.15	20,000	1,380
HP010-2-A16	Type "M" (1" - 12)	4.08	103.63	1.62	41.15	20,000	1,380
HP010-2-NFD	1/2" NPT Female	4.14	105.16	1.62	41.15	15,000	1,030
HP010-2-NMD	1/2" NPT Male	4.13	104.90	1.62	41.15	15,000	1,030
HP010-2-X23	Low Angle Face Seal (3/4" - 16)	4.18	106.17	1.62	41.15	20,000	1,380

Construction: Alloy steel

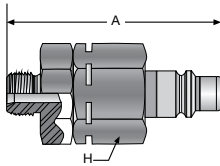

HP010-2-A12  
HP010-2-A16

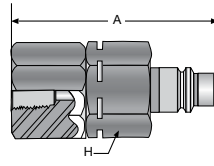

HP010-2-NFD

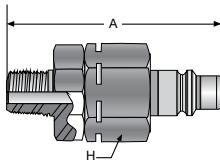

HP010-2-NMD

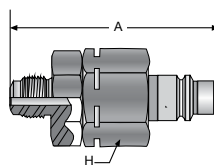

HP010-2-X23



### WARNING

This product can expose you to chemicals including Lead, which is known to the State of California to cause cancer and birth defects or other reproductive harm. For more information go to [www.P65Warnings.ca.gov](http://www.P65Warnings.ca.gov).

# C Series Quick Couplings



## Features:

- Working pressures up to 29,000 psi
- Non-drip valving for clean, safe, trouble-free performance and minimal air inclusion
- Built-in safety locking device to prevent accidental disconnect
- Wide range of threaded styles: NPT, BSP and "High Pressure"
- Adapters for ease of connection to high pressure hoses and fixed ports
- Thread sizes from 1/8" to 3/8"
- Protective dust caps are included to prevent damage and fluid contamination in disconnected position
- Rugged design and construction for long life in demanding applications

## Applications:

- Torque Tensioning
- Stud Tensioning
- Rescue
- Bearing Pullers
- Intensifiers
- Hydrostatic Testing
- Pumps
- Jacks
- Spreaders
- Cable Cutters
- Nut Splitters
- Pipe Coupling Swagers
- Presses
- Clamping Fixtures
- Crimpers
- Blow-out Preventors

Type	Max. Working Pressure (psi)	Test Pressure (psi)	Nominal Thru Hold Diameter (in)
C Series 115	14,500	21,800	0.11
C Series 116	21,800	29,200	0.11
C Series 125	29,800	36,300	0.11

**Note:** The choice of the threaded end form may limit the working pressure and the size of the thru hole in the coupling. Call **polyflex** for additional information.





### WARNING

This product can expose you to chemicals including Lead, which is known to the State of California to cause cancer and birth defects or other reproductive harm.

For more information go to [www.P65Warnings.ca.gov](http://www.P65Warnings.ca.gov).

# C Series Quick Couplings

## 115 Coupler

Part Number	Thread Type	A Overall Length		H Hex		Maximum Working Pressure	
		inch	mm	inch	mm	psi	bar
#							
C10-115-1202	1/4" BSP Female (thru type)	2.30	58.42	0.94	23.88	14,500	1,000
C10-115-1222	1/4" BSP Female (with built-in locking device)	2.30	58.42	0.94	23.88	14,500	1,000
C10-115-1401	1/8" NPT Female	2.30	58.42	0.94	23.88	14,500	1,000
C10-115-1402	1/4" NPT Female	2.30	58.42	0.94	23.88	14,500	1,000
C10-115-1404	3/8" NPT Female	2.38	60.45	0.94	23.88	14,500	1,000
C10-115-1422	1/4" NPT Female (with built-in locking device)	2.30	58.42	0.94	23.88	14,500	1,000
C10-115-1452	1/4" NPT Male	2.45	62.23	0.94	23.88	14,500	1,000
C10-115-1454	3/8" NPT Male	2.45	62.23	0.94	23.88	14,500	1,000

Construction: All exposed components are made of zinc-plated steel.

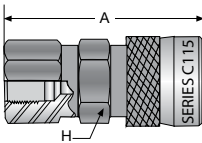

C10-115-1202

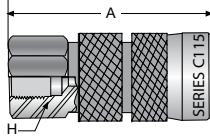

C10-115-1222

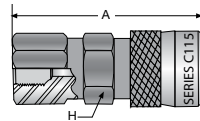

C10-115-1401  
C10-115-1402  
C10-115-1404

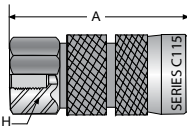

C10-115-1422

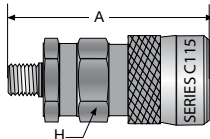

C10-115-1452  
C10-115-1454





**WARNING**

This product can expose you to chemicals including Lead, which is known to the State of California to cause cancer and birth defects or other reproductive harm. For more information go to [www.P65Warnings.ca.gov](http://www.P65Warnings.ca.gov).

# C Series Quick Couplings

## 115 Nipple

Part Number	Thread Type	A Overall Length		H Hex		Maximum Working Pressure	
		inch	mm	inch	mm	psi	bar
#							
C10-115-6202	1/4" BSP Female	1.47	37.34	0.87	22.10	14,500	1,000
C10-115-6204	3/8" BSP Female	1.56	39.62	0.94	23.88	14,500	1,000
C10-115-6401	1/8" NPT Female	1.42	36.07	0.87	22.10	14,500	1,000
C10-115-6402	1/4" NPT Female	1.42	36.07	0.87	22.10	14,500	1,000
C10-115-6404	3/8" NPT Female	1.46	37.08	0.94	23.88	14,500	1,000
C10-115-6452	1/4" NPT Male	2.40	60.96	0.87	22.10	14,500	1,000
C10-115-6454	3/8" NPT Male	2.55	64.77	0.94	23.88	14,500	1,000

Construction: All exposed components are made of zinc-plated steel.

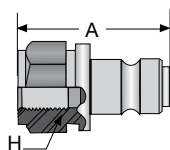

C10-115-6202  
C10-115-6204

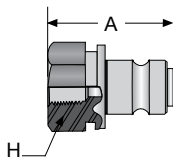

C10-115-6401  
C10-115-6402  
C10-115-6404

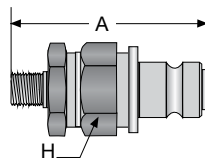

C10-115-6452  
C10-115-6454





### WARNING

This product can expose you to chemicals including Lead, which is known to the State of California to cause cancer and birth defects or other reproductive harm. For more information go to [www.P65Warnings.ca.gov](http://www.P65Warnings.ca.gov).



# C Series Quick Couplings

## 116 Coupler

Part Number	Thread Type	A Overall Length		H Hex		Maximum Working Pressure	
		inch	mm	inch	mm	psi	bar
#							
C10-116-1202	1/4" BSP Female	2.30	58.42	0.94	23.88	21,750	1,500
C10-116-1222	1/4" BSP Female (with built-in locking device)	2.30	58.42	0.94	23.88	21,750	1,500
C10-116-1402	1/4" NPT Female	2.30	58.42	0.94	23.88	15,000	1,035
C10-116-1422	1/4" NPT Female (with built-in locking device)	2.30	58.42	0.94	23.88	15,000	1,035

Construction: All exposed components are made of zinc-plated steel.

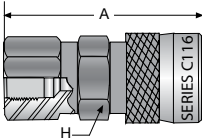

C10-116-1202

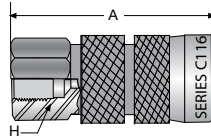

C10-116-1222

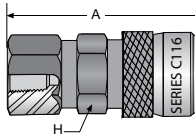

C10-116-1422

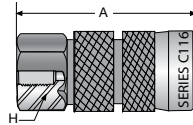

C10-116-1402





**WARNING**

This product can expose you to chemicals including Lead, which is known to the State of California to cause cancer and birth defects or other reproductive harm. For more information go to [www.P65Warnings.ca.gov](http://www.P65Warnings.ca.gov).

# C Series Quick Couplings

## 116 Nipple

Part Number	Thread Type	A Overall Length		H Hex		Maximum Working Pressure	
		inch	mm	inch	mm	psi	bar
#							
C10-116-5202	1/4" BSP Female (thru type)	1.47	37.34	0.87	22.10	21,750	1,500
C10-116-6202	1/4" BSP Female	1.47	37.34	0.87	22.10	21,750	1,500
C10-116-6402	1/4" NPT Female	1.41	35.81	0.87	22.10	15,000	1,035

Construction: All exposed components are made of zinc-plated steel.

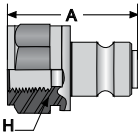

C10-116-5202

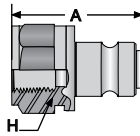

C10-116-6202

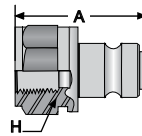

C10-116-6402





For detailed ordering information, please consult price list or contact Parflex Division.

Parker Hannifin Corporation | Parflex Division | Stafford, TX | [parker.com/ptd](http://parker.com/ptd)

# C Series Quick Couplings

## 125 Coupler

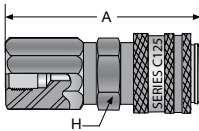

Part Number	Thread Type	A Overall Length		H Hex		Maximum Working Pressure	
		inch	mm	inch	mm	psi	bar
#							
C10-125-1203	1/4" BSP Female	2.53	64.26	0.95	24.13	36,300	2,500

Construction: All exposed components are made of zinc-plated steel.



C10-125-1203 Coupler

## 125 Nipple

Part Number	Thread Type	A Overall Length		H Hex		Maximum Working Pressure	
		inch	mm	inch	mm	psi	bar
#							
C10-125-5202	1/4" BSP Female (thru type)	1.50	38.10	0.87	22.10	29,000	2,000
C10-125-6203	1/4" BSP Female	1.50	38.10	0.87	22.10	36,300	2,500

Construction: All exposed components are made of zinc-plated steel.

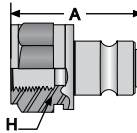
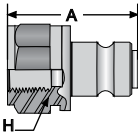

C10-116-5202 Nipple    C10-125-6203 Nipple



For detailed ordering information, please consult price list or contact Parflex Division.

Parker Hannifin Corporation | Parflex Division | Stafford, TX | [parker.com/pfd](http://parker.com/pfd)



# C Series Quick Couplings

## Quick Coupling Adapters

Part Number	Thread Type	A Overall Length		H Hex		Maximum Working Pressure	
		inch	mm	inch	mm	psi	bar
#							
C09-125-1680	1/4" BSP 120° external cone x 1/4" HP Male	1.72	43.69	0.67	17.02	29,000	2,000
C19-950-0029	1/4" BSP 120° external cone x 9/16" UNF	1.48	37.59	0.67	17.02	29,000	2,000
C19-950-0062	1/4" Rubber Metal Seal	0.08	2.03	0.81	20.57	14,500	1,000
C19-950-0064	3/8" Rubber Metal Seal	0.08	2.03	0.94	23.88	14,500	1,000
C19-950-1600	1/4" BSP 120° external cone Blind Plug	1.07	27.18	0.67	17.02	29,000	2,000
C19-950-1601	1/4" BSP x 1/4" BSP 120° external cones	1.76	44.70	0.08	2.03	29,000	2,000
C19-950-1602	1/4" BSP 120° external cone x 1/4" BSP 60° internal cone	1.54	39.12	0.83	21.08	29,000	2,000
C19-950-1622	1/4" BSP x 1/4" BSP with 60° internal cone	1.25	31.75	0.83	21.08	29,000	2,000
C19-950-1623	1/4" NPT Male x 1/4" BSP with 60° internal cone	1.27	32.26	0.83	21.08	14,500	1,000
C19-950-1680	Porting Block	1.8	45.72	N/A	N/A	29,000	2,000
HAHM4BM4	1/4" BSP with 60° internal cone x 1/4" HP Male	1.47	37.34	0.83	21.08	30,000	2,070

Construction: All C19 part numbers are manufactured with black zinc-plated steel.

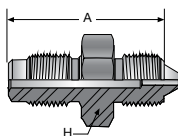

C09-125-1680

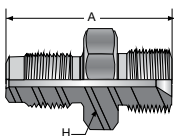

C19-950-0029

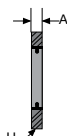

C19-950-0062  
C19-950-0064

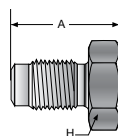

C19-950-1600

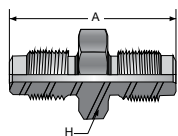

C19-950-1601

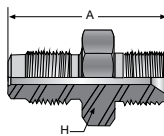

C19-950-1602

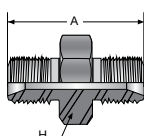

C19-950-1622

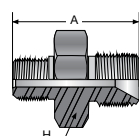

C19-950-1623

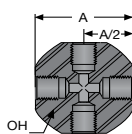

C19-950-1680

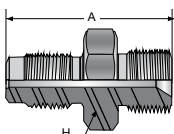

HAHM4BM4



**WARNING**

This product can expose you to chemicals including Lead, which is known to the State of California to cause cancer and birth defects or other reproductive harm. For more information go to [www.P65Warnings.ca.gov](http://www.P65Warnings.ca.gov).

# Accessories



Heavy Duty Abrasion  
Covers

Spring Guards

Containment and  
Support Grips

Bend Restrictors

Pressure Containment  
Shields

Anti-Gall Lubricant

Dies



# Table of Contents

## Accessories

Anti-Gall Lubricant.....	E-5
Bend Restrictors.....	E-3
Containment Grips .....	E-4
Dies .....	E-5
Heavy Duty Abrasion Cover .....	E-3
Heavy Duty Abrasion Cover Sleeves.....	E-3
Pressure Containment Shield.....	E-4
Spring Guards .....	E-3
Support Grips.....	E-4
Warning Tags.....	E-5

# Accessories



## Heavy Duty Abrasion Cover and Cover Sleeves

Part Number	Size I.D. (inch)	Size O.D. (inch)	Material	Reinforcement	Bend Radius (inch)	Weight (lbs/ft)	Cover Sleeves	Cover Sleeve Material
MHDC010	5/8	0.820	Clear Vinyl	Fiber Braid	3.0	0.15	508-J-500-10	Carbon Steel
MHDC012	3/4	0.938	Clear Vinyl	White PVC Helix	3.0	0.20	510-A-500-12	Aluminum
MHDC016	1	1.250	Clear Vinyl	White PVC Helix	3.0	0.27	216-200-18	Carbon Steel
MHDC018	1-1/8	1.350	Clear Vinyl	White PVC Helix	3.5	0.29	216-200-18 620-100-18 (w/ 2640N-08)	Carbon Steel Aluminum
MHDC024	1-1/2	1.825	Clear Vinyl	White PVC Helix	4.0	0.40	220-200-22	Carbon Steel
MHDC026	1-5/8	1.905	Clear Vinyl	White PVC Helix	4.0	0.52	520-A-500-26	Aluminum
PVC-BLUE-012	3/4	0.938	Clear Vinyl	Blue PVC Helix	3.0	0.20	510-A-500-12	Aluminum
PVC-BLUE-018	1-1/8	1.375	Clear Vinyl	Blue PVC Helix	3.0	0.29	216-200-18	Carbon Steel
PVC-BLUE-024	1-1/2	1.780	Clear Vinyl	Blue PVC Helix	5.0	0.40	220-200-22	Carbon Steel
PVC-ORANGE-012	3/4	0.938	Clear Vinyl	Orange PVC Helix	3.0	0.20	510-A-500-12	Aluminum
PVC-ORANGE-016	1	1.250	Clear Vinyl	Orange PVC Helix	3.0	0.27	412-400	Carbon Steel

## Spring Guards

Part Number	Size (I.D.)	Size (O.D.) <sup>1</sup>	Length (in)	Material	Designated Hose Series
MSG060	0.61	0.77	300.00	Stainless Steel	2440N-04
MSG2106	0.63	0.89	7.87	Carbon Steel	2380N-04



## Bend Restrictors

Part Number	I.D. (inch)	O.D. (inch)	Length (inch)	Material
MBR003	0.250"	0.515"	2.33	Molded Vinyl
MBR004	0.250"	0.490"	2.16	Molded Vinyl
MBR008	0.500"	0.800"	6.00	Molded Vinyl
MBR010	0.625"	0.925"	6.00	Molded Vinyl
MBR012	0.770"	1.070"	6.00	Molded Vinyl
MBR013-BLK	0.845"	1.100"	9.84	Molded Rigid Vinyl



### WARNING

This product can expose you to chemicals including Lead, which is known to the State of California to cause cancer and birth defects or other reproductive harm. For more information go to [www.P65Warnings.ca.gov](http://www.P65Warnings.ca.gov).

# Accessories



## Containment Grips

Part Number	Loop Size (inch)	Overall Length (inch)	Material	Breaking Strength (lbs)	Hose Size (O.D.)	Weight (lbs)
MCG001SS	1	25.5	Stainless Steel	2,900	0.38" - 0.69"	0.55
MCG002SS	2	37.5	Stainless Steel	9,400	1.00" - 1.56"	2.20
MCG003SS	1.26	65	Stainless Steel	14,400	1.25" - 1.94"	6.50
MCGHS10-15	0.71	26.18	Galvanized Steel	2,293	0.40" - 0.59"	0.15
MCGHS15-20	0.71	27.17	Galvanized Steel	2,900	0.59" - 0.79"	0.33
MCGHS20-30	0.71	26.97	Galvanized Steel	5,463	0.79" - 1.18"	0.40
MCGHS30-40	0.71	27.56	Galvanized Steel	7,891	1.18" - 1.57"	0.68
MCGHS40-50	0.71	28.54	Galvanized Steel	10,791	1.57" - 1.96"	1.04
MCGHS50-60	0.71	33.46	Galvanized Steel	10,791	1.96" - 2.36"	1.81
MCGHS3295-SS	4.50	81.50	Stainless Steel	49,000	1-1/2" and 2" (Black Eagle)	9.5



## Support Grips

Part Number	Loop Size (inch)	Overall Length (inch)	Material	Breaking Strength (lbs)	Hose Size (O.D.)	Weight (lbs)
MK022-03-038	4	9	Tin - Coated Bronze	750	0.63" - 0.74"	0.50
MK022-03-039	4	10	Tin - Coated Bronze	950	0.75" - 0.99"	0.25
MK022-03-041	5	12	Tin - Coated Bronze	1,500	1.00" - 1.24"	0.35
MK022-03-042	5	14	Tin - Coated Bronze	1,500	1.25" - 1.49"	0.40
MK022-03-043	5	15	Tin - Coated Bronze	1,500	1.50" - 1.74"	0.45
MK022-03-045	9	19	Tin - Coated Bronze	3,100	2.25" - 2.49"	1.25

## Pressure Containment Shield



Part Number	I.D. (inch)	O.D. (inch)	Retaining Sleeve	Stiffener	Material	Bend Radius (in)	Weight (lbs/ft)	Designated Hose Series
MHBS012	0.75	1.09	412-400	M55STIF-4, M55STIF-5, M55STIF-6	Rubber	9.5	0.42	2740D-03 and 2840D-03
MHBS016	1.00	1.41	416-400-16	N/A	Rubber	12.0	0.63	2740D-05 and 2840D-05



**WARNING**

This product can expose you to chemicals including Lead, which is known to the State of California to cause cancer and birth defects or other reproductive harm. For more information go to [www.P65Warnings.ca.gov](http://www.P65Warnings.ca.gov).



## Accessories

## Warning Tags

### Dies



Part Number	Description	Fitting Series
#		
80C-HP3	Dies for HP3 Fittings	HP
80C-HP4	Dies for HP4 Fittings	HP
80C-HP6	Dies for HP6 Fittings	HP
80C-G03	Dies for HP3 Guards	N/A
80C-G04	Dies for HP4 Guards	N/A
80C-G06	Dies for HP6 Guards	N/A
83C-8X16 83C-9X16	2380N-16	8X E4
83C-9X04	2390N-04	9X / E3
80-9X06	2390N-06	9X
83C-9X08	2390N-08	9X / E3
83C-9X16	2390N-16	9X / E4
83C-F08W	57CR-08	CR
83C-F16W	57CR-16	CR



Part Number	Description
G214-240	White - General warning tag should be applied to all hoses
G214-245	Yellow - Warning tag for flex lances

## ThreadMate® Anti-Gall Lubricant



Part Number	Description
#	
MTM04T	4 oz Tube
<p>ThreadMate® is an extreme duty lubricant developed to reduce galling during the assembly of threaded parts:</p> <p>ThreadMate® promotes reliable sealing of pipe threads, even at high pressure, by reducing friction and galling during tightening, resulting in higher contact pressures of the sealing surfaces and better metal-to-metal contact.</p> <p>ThreadMate® reduces the torque needed to make pressure-tight connections and tighten fasteners</p> <p>Shelf life: 2 years from manufacture date</p>	



#### WARNING

This product can expose you to chemicals including Lead, which is known to the State of California to cause cancer and birth defects or other reproductive harm. For more information go to [www.P65Warnings.ca.gov](http://www.P65Warnings.ca.gov).



# General Technical



Recommended  
Practices

Hose Selection,  
Installation, and  
Maintenance

Dash Size Systems  
for Hose and Tubing

Twin/Multi-line  
Separation  
Instructions

Government & Agency  
Approvals

Chemical Resistance  
Charts

Technical Data



# Table of Contents

## Hose Selection, Installation & Maintenance

Chemical Resistance Table, Typical Waterblast and General Hydraulics .....	F-10
Chemical Resistance Table, Offshore Hoses .....	F-26
Engineering Manual (PFDE-ES28): Recommended Practices for Handling, Maintenance and Inspection of Large Bore Hoses and Assemblies Used in Oil & Gas Applications .....	F-19
Engineering Manual (PFDE-ES29): Technical Matrix for Parker polyflex Offshore Hoses.....	F-14
Gas Permeability of Plastics.....	F-8
Hose Dash Sizes .....	F-4
Hose Installation Tips .....	F-5
Pressure Drop - Determination of Pressure Drop in the Line .....	F-7
Recommended Tightening Procedures.....	F-9
Selection of Hose Diameter from Flow Rate and Velocity.....	F-6
Selection, Installation and Maintenance of <b>polyflex</b> Hose and Hose Assemblies .....	F-3
Safety Guide .....	F-32
Offer of Sale.....	F-39
Part Number Index.....	F-41

# Selection, Installation & Maintenance of *polyflex* Hose and Hose Assemblies

Hoses and hose assemblies have a finite life span which can be affected by many factors. This recommended practice should be read by designers and users of hose to assist them in the proper selection of hose. These guidelines, while not exhaustive, will assist the user in maintaining hydraulic and pneumatic systems.

## READ THE PARKER SAFETY GUIDE IN ITS ENTIRETY ( F-32)

### PART 1 - How to select hose

- **Pressure** - Maximum operating pressure of the hose must be greater than or equal to the system pressure. Pressure surges or system "spikes" in excess of the maximum operating pressure will shorten hose life and must be avoided.
- **Temperature** - Ambient and fluid temperatures must not exceed the hose/fittings rated design temperature. Attempt to route hose away from or shield hose from high temperature sources.
- **Size** - Adequately size hose and fittings to avoid damaging hose with excessive turbulence, or heat build-up, while maintaining proper flow and pressure. (Refer to fluid velocity nomogram on F-6.)
- **Fluid Compatibility** - Refer to Chemical Resistance Table on F-10 for use of fluids with various materials. If unsure of an application, contact the factory. Additional care must be taken with gaseous applications. (Safety Guide F-32)
- **Environment** - Conditions such as ozone, UV light, harsh chemicals, salt water, and other airborne contaminants can degrade hose and shorten its life.
- **Length** - Hose length changes with pressure. This, along with equipment movement, must be considered in the system design.
- **Proper couplings** - Always follow manufacturers' specifications and do not mix components of different manufacturers.
- **Mechanical loads** - Conditions such as tensile and side loads, vibration, excessive flexing, and twist will reduce hose life. Use swivel fittings and adaptors to avoid hose twisting. Test the hose if the application is potentially problematic or unusual.
- **Electrical conductivity** - Determine if the hose must be non-conductive to prevent electrical current flow or conductive to dissipate static electricity. Choose hose and fittings accordingly. (See Safety Guide for Electrical Conductivity issues.)

### PART 2 - Installation & Maintenance

- **Inspect components** - Check hose for cover cracks, blisters, cleanliness, kinks, cracks or core tube obstructions or other defects. Examine fittings for poor threads, obstructions, cracks, rust. Do not use hose or fittings if these problems exist.
- **Assemble per instructions** - Instructions are available for companies, trained and authorized by Polyflex.
- **Do not exceed specified minimum bend radius** - Use stress relievers to prevent sharp bends at the hose and fitting juncture. These can be spring guards or other stress relieving members.
- **Ensure that hose bends rather than twists with equipment motion.**
- **Use a torque wrench or the flats from finger tight method to properly install port connections.**
- **After installation, eliminate air entrapped in system, pressurize to maximum operating pressure, and check for leaks and proper system function.**
- **After installation, periodically (frequency depends on severity of application and potential risk) inspect the system for the following:**
  1. Blistered, degraded, or loose hose covers
  2. Stiff, cracked, or charred hose
  3. Cuts or abrasion of hose — look for exposed reinforcement
  4. Leaks in hose or fittings
  5. Damaged or corroded fittings
  6. Excessive build up of dirt, grease, oils, etc.
  7. Defective or broken accessories (clamping devices, kink guards)
  8. Kinks in hoses
- Upon discovery of any of these items, replace it, repair it, but **DO NOT IGNORE IT!**
- Retest the system after all maintenance procedures.
- Establish replacement schedules based on previous service life, or when failures could result in damage, personal injury, or excessive/unacceptable downtime.

## Hose Dash Sizes

Dash sizes are commonly used to designate hose I.D., plastic tubing and metal tubing O.D. and coupling size. Dash size systems in common use:

Nominal Hose I.D. or Tubing O.D.		Dash number for all <i>polyflex</i> hose	Nominal DN Size
Inch	Millimeter		
3/32	2.0	-012	2
1/8	3.2	-2	3
5/32	4.0	-025 or 2A	4
3/16	4.8	-3	5
1/4	6.3	-4	6
5/16	7.9	-5	8
3/8	9.5	-6	10
13/32	10.3	-6.5	—
1/2	12.7	-8	12
5/8	15.9	-10	16
3/4	19.1	-12	20
7/8	22.2	-14	—
1	25.4	-16	25
1-1/8	28.6	—	—
1-1/4	31.8	-20	32
1-3/8	34.9	—	—
1-1/2	38.1	-24	40
1-13/16	46.0	—	—
2	50.8	-32	50

# Hose Installation Tips

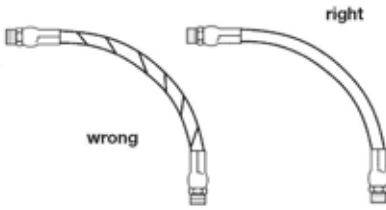

Hose is weakened when installed in twisted position. Also, pressure pulses in twisted hose tend to fatigue wire and loosen fitting connections. Design so that the machine motion produces bending rather than torsion.

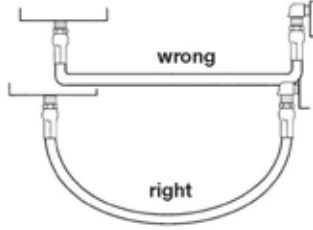

Hose should exit coupling in a straight position rather than side loaded. The minimum bend radius must not be exceeded to avoid kinking of hose and flow restriction.

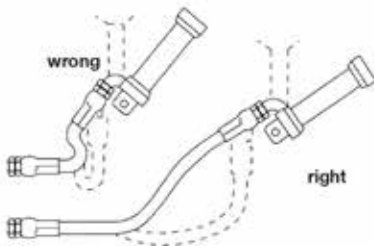

When hose assembly is installed in a flexing applications, remember that metal hose fittings are not part of the flexible portion.

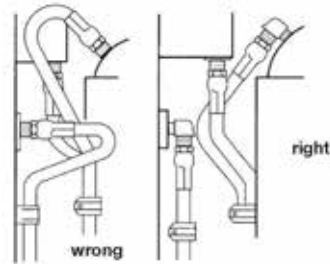

Use elbow or adapters as necessary to eliminate excess hose length and to ensure neater installation and easier maintenance.

Free hose length allowance:

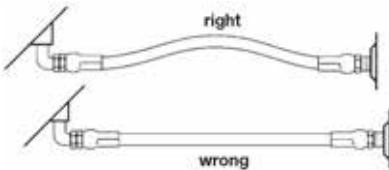

Pressure can change hose in length by as much as  $\pm 2\%$ . This must be considered when cutting hose to appropriate length.

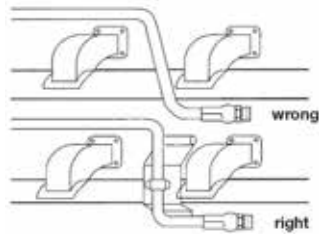

Avoid installing hose assemblies close to heat sources. However, if this should be required, insulate hose.

# Selection of Hose Diameter from Flow Rate and Velocity

Flow capacities of Parker hose at recommended flow velocities  
The chart below is provided as an aid in the determination of the correct hose size.

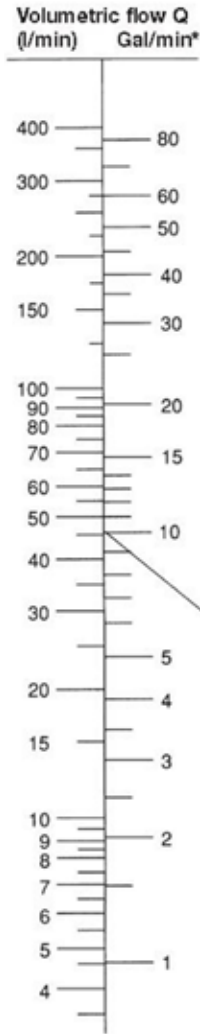

Example:  
At 10 gallons per minute in the left-hand column and 25 feet per second in the right-hand column (the maximum recommended velocity range for pressure lines). Lay a straight line across these two points. The inside diameter shown in the center column is above -6 so we have to use -8 (1/2").

For suction hose, follow the same procedure except use recommended velocity range for suction lines in the right-hand column.

Where: Q = flow in gallons per minute (gal/min & l/min)  
V = velocity in feet per second (f/s & m/s)  
d = hose inside diameter (mm & dash size)

Hose inner diameter d	
mm	dash sizes
50,8	-32
38,1	-24
31,8	-20
25,4	-16
19,1	-12
15,9	-10
12,7	-8
9,5	-6
7,9	-5
6,3	-4
4,8	-3

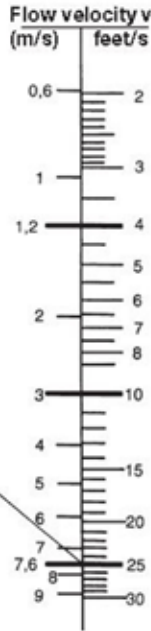

Recommended maximum velocity for suction lines

Recommended maximum velocity for return lines

Recommended maximum velocity for pressure lines

\*gallons are UK gallons  
Conversion factors:  
gal/min x 4.546 = l/min  
feet/s x 0.3948 = m/s

\*Recommended velocities are according to hydraulic fluids of maximum viscosity 315 S.S.U. at 38°C working at room temperature within 18°C and 68°C



# Pressure Drop - Determination of Pressure Drop in the Line

**Velocity:**  $v = .409 \frac{Q}{d^2} = .509 \frac{W}{pd^2} = \frac{q}{.785d^2}$

**Reynold's Number:**  $Re = 124 \frac{dvp}{\mu} = 6.31 \frac{W}{d\mu} = 378 \frac{qp}{d\mu}$

Pressure Drop, Isothermal, Incompressible Flow (Liquids):

$$\Delta P = .001294 \frac{fL p v^2}{d} = .00000336 \frac{fLW^2}{pd^5} = .0121 \frac{fL q^2}{d^5}$$

Pressure Drop, Isothermal, Compressible, long Lines (Gases and Vapors):

$$\frac{\Delta P}{P_1} = 1 - \sqrt{1 - \frac{fL p_1 v^2}{12 g d P_1}}$$

## Symbols and Units for Listed Formulas

- d** = Inside diameter of hose, inches
- f** = Friction coefficient, dimensionless
- g** = Gravitational constant, 32.2 ft/sec<sup>2</sup>
- P<sub>1</sub>** = Input pressure, psi
- ΔP** = Pressure difference, psi
- q** = Rate of flow at flowing condition, cu. ft/min
- Q** = Rate of flow, gals/min
- Re** = Reynolds number, dimensionless
- v** = Flow velocity, ft/sec
- W** = Rate of flow, lbs/hr
- p** = Weight density of fluid, lbs/cu. ft
- μ** = Absolute (dynamic) viscosity, centipoises

# Gas Permeability of Plastics

## Permeability Coefficient

$$\text{Permeability Coefficient} = \frac{V}{A \times T \times p}$$

Where: V is the volume of gas, in cm<sup>3</sup>, which diffuses through a 1mm thickness  
 A is the area across which the gas diffuses, in m<sup>2</sup>.  
 T is the diffusion time, in days.  
 p is the pressure difference across the plastic, in bar

### Permeability Coefficients per DIN 53380

Material	Gas				
	N <sub>2</sub>	O <sub>2</sub>	CO <sub>2</sub>	H <sub>2</sub>	He
PTFE	50	150	1,500	—	3,500
PVDF	3	2	10	—	60
PA-6 XE 3289	1	4	10	100*	60*
PA-6 A 28 NZ	0.5	2	5	50*	30*
PA-12 L 2124	—	30	180	210	160
PA-12 P40 TL	—	—	105	—	—
PA-12 L 25W40	8	35	150	1,000*	500*
PA-12 L 2140	—	12	71	—	130
PA-11 P 40 TL	—	—	55	130	—
PA-11 POTL	2	20	65	65	—
POM H 2320	5	10	130	35	40
POM 150 SA	2	4	20	—	—
PEE 4055	150	—	3,000	—	1,400
PEE 5556	120	—	1,600	—	900
PEE 7246	—	—	—	—	300

\* Calculated value. Diffusion constants based on normal room temperature. Actual behavior may vary considerably because of variations in processing the plastic.

# Recommended Tightening Procedures

Connection	Thread Sizes	Tightening Torque	
		ft•lb	N•m
<b>High Pressure</b>			
1/4"	9/16" - 18	25	34
3/8"	3/4" - 16	50	69
9/16"	1-1/8" - 12	75	103
<b>Medium Pressure</b>			
1/4"	7/16" - 20	20	28
3/8"	9/16" - 18	30	41
9/16"	13/16" - 16	85	117
3/4"	3/4" NPSM	90	124
1"	1-3/8" - 12	125	173

Connection	Thread Sizes	Tightening Torque	
		ft•lb	N•m
<b>Type "M" Swivel</b>			
A9	9/16" - 18	25-30	34-41
A12	3/4" - 16	40-50	55-69
A14	7/8" - 14	50-60	69-83
A16	1" - 12	75-85	103-117
A21	1-5/16" - 12	100-120	138-166
<b>JIC</b>			
1/4"	7/16" - 20	11-12	15-16
3/8"	9/16" - 18	18-21	25-28
1/2"	3/4" - 16	36-39	49-52
3/4"	1-1/16" - 12	80-88	109-119
1"	1-5/16" - 12	100-108	136-146

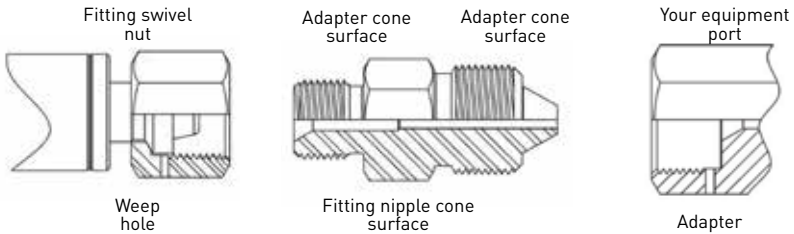

## Leakage at swivel nut-to-adapter Joint

(Seen by leak at weep hole in swivel nut)

1. Reduce system pressure to zero
2. Unscrew swivel nut and check cone surfaces of adapter and hose insert
3. If hose insert is damaged, return hose to **polyflex** for repair and retest
4. If cone surfaces look good after cleaning, re-tighten swivel nut. Do not exceed 150% of recommended torque.

## Leakage at type "M" adapter-to-port

(Seen by leak at weep hole in pressure port, or leak at threads for NPT adapters.)

1. Reduce system pressure to zero
2. Slacken hose swivel nut
3. Tighten adapter into port
4. Re-tighten swivel nut

Never use the swivel nut to tighten the adapter into the port.

# General Chemical Resistance Table

## Typical Waterblast and General Hydraulics

### Ratings Code

- G — Good to excellent. Little or no swelling, tensile or surface changes. Preferred choice.
- L — Marginal or conditional. Noticeable effects but not necessarily indicating lack of serviceability. Further testing suggested for specific application. Very long-term effects such as stiffening or potential for crazing should be evaluated.
- P — Poor or unsatisfactory. Not recommended without extensive and realistic testing.
- — Indicates that this was not tested.

### Materials Code for Hose Core Tubes

- N Polyamide
- M Coextruded tube with Fluoropolymer inner liner
- POM Polyoxymethylene

For offshore  
oil and gas hoses,  
see page F-26

### Materials Code for Hose Cover

- N Polyamide
- U/HF Polyurethane

### Notes on the Chemical Resistance Table

- The fluid resistance tables are simplified rating tabulations based on immersion tests at 24°C. Higher temperatures tend to reduce ratings. Since final selection depends on pressure, fluid and ambient temperature and other factors not known to Parker Hannifin, no performance guarantee is expressed or implied. The indications do not imply any compliance with standards and regulations and do not refer to possible changes of color, taste or smell. For food and drinking water specially approved materials have to be used. For fluids not listed or for advice on particular applications, please consult Parker Hannifin GmbH, **polyflex** Division in Hüttenfeld, Germany.
- Hose applications for these fluids must take into account legal and insurance regulations. The chemical resistance indicated does not express or imply approval by certain institutions.
- Satisfactory at some concentrations and temperatures, unsatisfactory at others.
- For gas applications, the cover should be pin-pricked and the pressure must not be released quickly. Special safety guard accessories are to be used to prevent damage or personal injury in the event of failure.
- Chemical resistance does not imply low permeation rates. Please consult Parker Hannifin for a recommendation for your specific requirements.
- The indication of chemical resistance does not imply any special food compatibility; it refers only to the chemical resistance of the material.
- Chemical resistance does not imply acceptability for use in airless paintspray applications. These applications require a special, electrically conductive hose. Reference the Safety Guide, 2.1.2

Not all remarks may apply to Oil & Gas products

# General Chemical Resistance Table

## Typical Waterblast and General Hydraulics

Chemical	POM	N	U	M
Acetone	L	G	P	L
Acetylene	—	—	—	—
Air (4)	G	G	G	G
Ammonium Chloride	—	P	G	G
Ammonium Hydroxyde	—	G	P	G
Anhydrous Ammonia	—	P	P	—
Aniline	—	P	P	G
Aromatic Hydrocarbons	—	G	L	—
Asphalt	—	G	G	L
Benzene	—	G	L	G
Butane (2) (4)	—	G	L	—
Calcium Chloride	—	—	G	G
Carbon Dioxide (4)	—	G	G	—
Carbon Monoxide (4)	—	—	G	—
Carbon Tetrachloride	—	G	P	G
Chlorinated Hydrocarbon Base Fluids	—	G	L	—
Chlorinated Petroleum Oil	—	G	L	—
Chlorinated Solvents	—	—	P	—
Chlorine, Gaseous, Dry	—	P	P	—
Chromic Acid	—	—	P	L
Citric Acid Solutions	—	G	L	G
Crude Petroleum Oil	G	G	G	—
Cyclohexan (2)	—	G	G	G
Diesel Fuel (2)	G	G	G	—
Diester Oils	—	G	P	—
Ethanol (6)	G	G	L	—
Ethers	P	G	P	G
Ethylene Glycol	G	G	L	G
Ethylene Oxide	—	G	L	—
Fatty Acids	—	G	—	G
Formaldehyde	—	L	P	G
Formic Acid J	—	P	P	G
Fuel Oil (2)	G	G	L	G
Gas [Oil] (2)	—	G	G	—
Gasoline	—	G	—	G
Glycerine	—	G	L	G
Glycols (to 135°F)	G	G	L	G
Grease (petroleum base)	G	G	G	—

See page F-10 for instructions on using this chart

Hose  
A  
Fittings  
B  
Adapters & Valves  
C  
Quick Couplings  
D  
Accessories  
E  
General Technical  
F

# General Chemical Resistance Table

## Typical Waterblast and General Hydraulics

Chemical	POM	N	U	M
Hexane [2]	—	G	G	G
Hydraulic Fluid (petroleum base)	G	G	G	L
Hydraulic Fluid (phosphate ester base)	—	G	L	—
Hydraulic Fluid (water base)	—	G	G	—
Hydraulic Oil (petroleum base)	G	G	G	L
Hydrochloric Acid	—	L	P	G
Hydrofluoric Acid	—	P	P	G
Hydrolube (hydraulic fluid/water glycol base)	—	G	L	—
IRUS 902 (hydraulic fluid/water-oil emulsion)	—	G	G	—
Isooctane [2]	—	G	G	G
Kerosene [2]	—	G	L	G
Ketones	—	G	P	G
Lime (calcium oxide)	—	G	G	G
Lindol (hydraulic fluid/phosphate esters)	—	G	P	—
LP-Gas	—	—	—	—
Lubricating Oils (diester base)	—	G	P	—
Lubricating Oils (petroleum base)	G	G	G	G
Methane	—	—	—	—
Methanol	—	G	P	—
Methyl Alcohol [6]	G	G	P	G
Methyl Ethyl Ketone (MEK)	L	G	P	G
Methyl Ethyl Ketone Peroxide (MEKP)	—	L	P	—
Methyl Isobutyl Ketone (MIBK)	—	G	P	G
Methylen Chloride	P	L	P	G
Mineral Oil	G	G	G	G
Mineral Spirits	—	—	L	—
Motor Oils	—	G	G	G
Naphta	G	G	P	G
Natural Gas [4]	—	—	—	—
Nitric Acid	—	P	P	L
Nitrobenzene	—	G	P	G
Nitrogen, Gaseous [4] [5]	—	G	G	G
Nitrous Oxide	—	L	—	—
Oil (SAE)	G	G	G	—
Oxygen, Gaseous [4] [5] [6]	—	G	G	G
Pentane [2]	—	G	L	G
Perchloric Acid	—	P	P	L

See page F-10 for instructions on using this chart

# General Chemical Resistance Table

## Typical Waterblast and General Hydraulics

Chemical	POM	N	U	M
Petroleum Ether	—	—	—	—
Petroleum Oils	—	G	G	—
Phenols	—	P	P	—
Phosphate Esters (above 135°F)	—	G	P	—
Phosphate Esters (to 135°F)	—	G	P	—
Propane (4) (5)	—	—	—	—
Propylen Glycol	—	—	G	G
Salt Water	—	—	—	G
Silicone Greases	—	G	G	—
Silicone Oils	—	G	G	—
Sodium Borate	—	G	G	G
Sodium Carbonate	—	—	—	—
Sodium Chloride Solutions	—	G	G	G
Sodium Hydroxide, 50%	—	P	P	G
Sodium Hypochloride	—	P	P	G
Steam	—	P	P	G
Straight Synthetic Oils (phosphate esters)	—	G	P	—
Sulphur Dioxide	—	L	L	G
Sulphur Hexafluoride Gas (4) (5)	—	G	G	—
Sulphuric Acid	—	P	P	—
Toluol, Toluene	G	G	L	G
Trichlorethylene	—	L	P	G
Ucon (hydraulic fluid/water glycol base)	—	G	L	—
Water (above 60°C) (6)	G	G	P	L
Water (to 60°C) (6)	—	G	G	G
Water Glycols (above 60°C)	—	L	P	—
Water Glycols (to 60°C)	—	G	L	—
Water in oil Emulsions (above 60°C)	—	L	P	—
Water in oil Emulsions (to 60°C)	G	G	L	—
Xylene	G	G	P	G
Zinc Chloride	—	G	G	G

See page F-10 for instructions on using this chart

Hose  
**A**  
 Fittings  
**B**  
 Adapters & Valves  
**C**  
 Quick Couplings  
**D**  
 Accessories  
**E**

**F** General Technical

# PFDE-ES28: Technical Matrix for *polyflex* Offshore Hoses

## PARKER ENGINEERING MANUAL Technical Matrix for Parker *polyflex* Offshore Hoses

Parker Publication No. PFDE-ES28, Revised: March 2013

### Scope

This engineering standard contains the main information which is important for the selection of hose for offshore applications.

Guidelines for handling and storage of hose, see PFDE-ES28 on pg F-19.

### Notes

Detailed information is available in the appropriate hose data sheets. They always have precedence.

Most of the hoses have been fully qualified according to ISO 13628-5 for the working pressures stated, some at even higher pressures and temperatures. Contact Parker for detailed information.

Working pressures stated below are based on safety factor 4:1.

Maximum lengths values are approximate ones. Most of them have been proven during the manufacturing process.

Collapse pressures are typical values. Some of them have been measured on straight hoses, some at the hose minimum bend radius. The values measured at the minimum bend radius as per ISO 13628-5 are highlighted in all tables in *italic underlined*.

All values are only valid for hose assemblies, assembled with appropriate Parker fittings acc. to Parker assembly instructions assembled by Parker trained operators.



# PFDE-ES28: Technical Matrix for *polyflex* Offshore Hoses

## 1 Hoses with methanol washed Nylon 11 core tube, multiple layers of steel wire and a Nylon outer jacket

Working temperature for these hoses is (-40°F to +212°F) (-40°C to +100°C).

For chemical resistances of core tubes, see PFDE-ES28 on pg F-19.

Hose Part No.	Nominal I.D.	Nominal O.D. (mm)	Working Pressure		Burst Pressure		Max. Manufact. Length (m)	Weight in Air (kg/m)	Collapse Pressure (bar)
			psi	bar	psi	bar			
2380N-04V91	6.4 mm 1/4" Size -04	13.4	10,000	690	40,000	2,760	3,200	0.27	220
2440N-04V91		13.1	12,500	875	50,000	3,500	3,200	0.31	260
2448N-04V91		13.7	15,000	1,035	60,000	4,140	3,000	0.38	445
2390N-06V91	9.5 mm 3/8" Size -06	18.1	6,450	445	25,800	1,780	3,200	0.41	150
2440N-06V91		19.5	12,500	875	50,000	3,500	3,200	0.73	320
2390N-08V91	12.7 mm 1/2" Size -08	21.2	6,000	415	24,000	1,660	3,500	0.57	85
2440N-08V91		22.7	11,745	810	46,980	3,240	3,000	0.94	190
2390N-12V91	19.1 mm 3/4" Size -12	29	5,000	345	20,000	1,380	3,200	0.9	75
2440N-12V91*		30.2	10,000	690	36,250	2,500	2,000	1.47	80
2640N-12V91		33.2	12,500	875	50,000	3,500	1,800	2.16	120
2390N-16V91	25.4 mm 1" Size -16	35	4,060	280	16,240	1,120	3,200	1.17	39
2440N-16V91		37.2	8,120	560	32,625	2,250	2,000	1.9	60

\* Working pressures for these hoses are based on safety factors lower than 4:1.

Hose  
A

Fittings  
B

Adapters & Valves  
C

Quick Couplings  
D

Accessories  
E

General Technical  
F

# PFDE-ES28: Technical Matrix for *polyflex* Offshore Hoses

## 1.1 Large bore hoses with additional TPU outer jacket, "ColorGard™"

Hose Part No.	Nominal I.D.	Nominal O.D. (mm)	Working Pressure		Burst Pressure		Max. Manufact. Length (m)	Weight in Air (kg/m)	Collapse Pressure (bar)
			psi	bar	psi	bar			
2640N-24V80*	38.1 mm 1-1/2" Size -24	70.5	10,000	690	33,350	2,300	600	7.2	65
2640N-24V80-KOP*		70.5	15,000	1,035	33,750	2,330	600	7.2	65
2640N-24V80-KOP2*		66	15,000	1,035	33,750	2,330	600	6.5	65
2448N-32V80 PHalcon 2	50.8 mm 2" Size -32	80	5,000	345	20,000	1,380	1,000	8.8	49
2580N-32V80* Black Eagle 2		84	10,000	690	25,000	1,725	1,000	9.4	57
2240N-48V80* Black Eagle	76.2 mm 3" Size -48	114	5,000	345	12,500	862	350	11.5	20
2440N-48V80* Black Eagle		122	10,000	690	25,000	1,725	300	18.7	40
2640N-48V80* Black Eagle		130	15,000	1,035	33,750	2,330	250	27.5	80

\* Working pressures for these hoses are based on safety factors lower than 4:1.

# PFDE-ES28: Technical Matrix for *polyflex* Offshore Hoses

## 2 ChemJec hoses with fluoropolymer core tube, multiple layers of steel wire and a Nylon outer jacket

Working temperature for these hoses is (-40°F to +212°F) (-40°C to +100°C).

These hoses have an excellent chemical resistance against most of the aggressive chemicals.

Hose Part No.	Nominal I.D.	Nominal O.D. (mm)	Working Pressure		Burst Pressure		Max. Manufact. Length (m)	Weight in Air (kg/m)	Collapse Pressure (bar) (see Notes on pg F-19)
			psi	bar	psi	bar			
2240M-04V38	6.4 mm 1/4" Size -04	11.6	6,250	430	25,000	1,725	3,500	0.17	105
2340M-04V38		12.5	10,000	690	40,000	2,760	3,500	0.23	205
2380M-04V38		13.4	10,000	690	40,000	2,760	3,200	0.27	400
2440M-04V38		13.1	12,500	875	50,000	3,500	3,200	0.31	295
2448M-04V38		13.7	15,000	1,035	60,000	4,140	3,000	0.38	378
2380M-05V38	7.9 mm 5/16" Size -05	15.8	8,700	600	34,800	2,400	2,000	0.35	167
2440M-05V38		16.15	10,000	690	40,000	2,760	2,500	0.49	260
2448M-05V38		16.2	15,000	1,035	60,000	4,140	2,500	0.52	385
2370M-06V38	9.5 mm 3/8" Size -06	16.5	6,250	430	25,000	1,725	2,500	0.33	150
2440M-06V38		19.5	10,000	690	50,000	3,500	3,200	0.73	370
2448M-06V38		20.1	15,000	1,035	60,000	4,140	3,000	0.83	390
2440M-08V38		22.7	10,000	690	40,000	2,760	3,000	0.94	252
2640M-08V38	12.7 mm 1/2" Size -08	24.7	15,000	1,035	60,000	4,140	2,800	1.34	300
2390M-12V38	19.1 mm 3/4" Size -12	29.0	5,000	345	20,000	1,380	3,200	0.9	75
2440M-12V38*	30.2	10,000	690	36,250	2,500	2,000	1.47	110	
2390M-16V38	25.4 mm 1" Size -16	35.0	4,000	280	16,000	1,120	3,200	1.19	35
2440M-16V38-5K	37.2	5,000	345	32,625	2,250	2,000	2.05	65	

\* Working pressures for these hoses are based on safety factors lower than 4:1.

## 2.1 Large bore hoses with additional TPU outer jacket, "ColorGard™"

Hose Part No.	Nominal I.D.	Nominal O.D. (mm)	Working Pressure		Burst Pressure		Max. Manufact. Length (m)	Weight in Air (kg/m)	Collapse Pressure (bar) (see Notes on pg F-24)
			psi	bar	psi	bar			
2640M-24V88*	38.1 mm 1-1/2" Size -24	70.5	10,000	690	33,350	2,300	600	7.2	65
2448M-32V88 Phalcon 5000 2	50.8 mm 2" Size -32	80.5	5,000	345	20,000	1,380	600	8.5	49
2580M-32V80* Golden Eagle 2		84.5	10,000	690	25,000	1,725	600	9.4	65

\* Working pressures for these hoses are based on safety factors lower than 4:1.

# PFDE-ES28: Technical Matrix for *polyflex* Offshore Hoses

## 3 SeaWolf® high collapse resistance aramid reinforced hoses with nylon core tube and TPU outer jacket

Working temperature for these hoses is (-40°F to +140°F) (-40°C to +60°C).

For chemical resistances of core tube, see PFDE-ES28 on pg F-19

Hose Part No.	Nominal I.D.	Nominal O.D. (mm)	Working Pressure		Burst Pressure		Max. Manufact. Length (m)	Weight in Air (kg/m)	Collapse Pressure (bar) (see Notes on pg F-24)
			psi	bar	psi	bar			
57CR-8-BLU	12.7 mm 1/2" Size -08	30	5,000	34.5	20,000	1,380	200	0.94	230
57CR-16-BLU	25.4 mm 1" Size -16	51	5,000	34.5	20,000	1,380	200	2.17	210

## 4 Hoses with methanol washed Nylon 11 core tube, multiple aramid yarn braids and a TPU outer jacket

Working temperature for these hoses is (-40°F to +130°F) (-40°C to +55°C).

For chemical resistances of core tubes, see PFDE-ES24.

Hose Part No.	Nominal I.D.	Nominal O.D. (mm)	Working Pressure		Burst Pressure		Max. Manufact. Length (m)	Weight in Air (kg/m)	Collapse Pressure (bar) (see Notes on pg F-24)
			psi	bar	psi	bar			
2022N-04V91-5K	6.4 mm 1/4" Size -04	12.7	5,000	34.5	20,000	1,380	2,000	0.12	50
2022N-04V91-10K-13MM		12.9	10,000	69.0	40,000	2,760	3,000	0.12	75
2022N-04V91-10K		13.8	10,000	69.0	40,000	2,760	2,500	0.14	60
2022N-06V91-5K	9.5 mm 3/8" Size -06	16.1	5,000	34.5	20,000	1,380	2,000	0.15	14
2022N-06V91-10K		19.0	10,000	69.0	40,000	2,760	2,000	0.19	40
2022N-08V91-5K	12.7 mm 1/2" Size -08	20.8	5,000	34.5	20,000	1,380	2,000	0.17	<10
2022N-08V91-10K		23.2	10,000	69.0	40,000	2,760	1,500	0.34	19

\* Working pressures for these hoses are based on safety factors lower than 4:1.

# PFDE-ES28: Handling, Maintenance and Inspection of *polyflex* Offshore Hoses

## PARKER ENGINEERING MANUAL

### Instructions for Handling, Maintenance, Inspection and Repair of *polyflex* "1-3" Large Bore Hoses and Assemblies Used in Oil & Gas Applications

Parker Publication No. PFDE-ES28, Revised: October 2014

#### 1 Scope

This engineering standard is focused mainly on larger bore (1"-3"), long length Parker Polyflex multispiral wire-reinforced hoses used in well service operations. It is also relevant for shorter length hose assembly applications such as chemical injection, stimulation, cementing, flexible and testing lines. It provides information on recommended practices for handling, maintenance, inspection, and repair of hose assemblies.

Deployed as single line hoses or used in bundles, these hoses are available in sizes from 3/16" to 3" inside diameter with working pressures up to 1035 bar / 15,000 psi and continuous lengths greater than 3000 m, depending on size.

Hose can be self-supporting, clamped, supported by a guide wire or strengthened with an additional tensile reinforcement.

Parker Polyflex have certified several specialized testing facilities and their personnel to assemble, inspect, test and repair hose assemblies. Hose management is an essential part of the service they provide.

SAE J1273, ISO 17165-2, API RP 17B and ISO 13628 are excellent documents providing general guidelines for selection, routing, fabrication, installation, replacement, maintenance, and storage of hose and hose assemblies. Together with Parker Polyflex field experience, they provide the basis for the recommendations included in this engineering standard.

#### 2 Hose Features

Parker Polyflex Oil & Gas multispiral wire-reinforced hoses have been used for over 30 years in both onshore and offshore applications. They are proven to be tough, easy to handle, lightweight (compared with alternatives), and offer excellent chemical resistance, integral external collapse, ozone and microbiological resistance.

In extreme, abrasive applications, Polyflex offers an additional extra thick ColorGard™ sheath incorporating a dual color "early warning" safety feature.

##### 2.1 Design Life

Parker Polyflex large bore hoses are designed for prolonged service life. The prerequisite for this design life is that the hoses are used within the operating limits stated in the hose specification sheets. These limits include, but are not limited to, working pressure, number of pressure cycles, temperature range and bending radius.

In order to ensure a long service life, Parker Polyflex incorporates a combination of raw material suppliers testing and data, fatigue testing, and accelerated and specialized testing into the design of the hoses.

Obviously, due to many other factors affecting the service life, it is not possible to predict or guarantee service life of each individual hose assembly.

These factors may include, but are not limited to, mechanical loads (bending, torsion, tensile loads), frequent changes of temperature within the specified range, improper handling and storage, chemical attack, abrasive fluids, hose damage etc.

# PFDE-ES28: Handling, Maintenance and Inspection of *polyflex* Offshore Hoses

## 3 Storage

Hoses and hose assemblies should be stored, wherever possible, empty and protected from the elements in a stress free condition either straight, in a coil, or on a drum. The inside diameter of the coil or drum should not be less than two times the minimum bend radius. If a hose assembly has been used with chemicals, it shall be flushed with water before putting it to storage (see also 5.4).

Example: hose with minimum bend radius 800 mm; minimum size of drum core/belly should be  $2 \times 800 \text{ mm} = 1.6 \text{ m}$ .

The fittings should be capped to prevent ingress of dirt or other contamination and any exposed threads protected from damage.

Storage of hoses and hose assemblies should take into account potential exposure to corrosive liquids, rodents, insects, UV light and high temperatures. Storage temperatures should be in the range of hose operating temperatures.

## 4 Handling

### 4.1 Personnel

Only trained personnel shall handle and connect hose assemblies.

Incorrect handling will seriously reduce the lifetime of the hose and could cause dramatic failure. The use of wire rope or chains directly against the outer cover should be avoided, and the routing of the assembly should ensure the hose is never bent below its minimum bend radius or twisted. Special attention should be paid to the area at the back of the fitting.

### 4.2 Spooling and Reeling

When reeling long length hose onto a drum it is essential to minimize the tension on the hose. Proof testing of a "stretched" hose while on the drum can cause premature failure of the hose or damage to the drum.

When operating from a vessel it is recommended that the hose is pressurized during the subsea deployment and retrieving operation. This recommendation is based on the fact that during these operations the hose is always subjected to tensile force, at least due to its own weight. Tensile forces will result in hose elongation and possible deformation.

This is significantly reduced by pressurizing the hose, especially important if it is planned to proof test the hose assembly while coiled on a drum or winch. Deployment and retrieving pressures up to 200 bar had been found to be sufficient but this depends on the hose type and local safety regulations. For recommendations of pressure / load values see Appendix 2.

When re-spooling a long length assembly, the pay-off and take-up drums should be inline and a minimum of 10m apart. Depending on how the hose was delivered or re-spooled, the hose shall be spooled from either the top of the pay-off drum onto the top of the take-up drum or from bottom to bottom. (See Fig. 1 and Fig. 2 on next page.) These recommendations minimize the possibility of inducing twist into the hose.

When re-spooling a new hose that has a polyurethane cover, it is recommended to lubricate the hose cover with soapy water or other suitable lubricant so the hose will traverse more easily and position itself correctly onto the take-up drum/winch. See Fig. 1 (next page).

It is also recommended, when deploying the hose through a moon pool or over the side of a vessel, to align the hose routing in the same manner. See Fig. 2 (next page).

### Note:

When first supplied, the layline printed on the hose is normally straight and visible. Twisting of the layline is an early indication of poor alignment or high tensile loading.

# PFDE-ES28: Handling, Maintenance and Inspection of *polyflex* Offshore Hoses

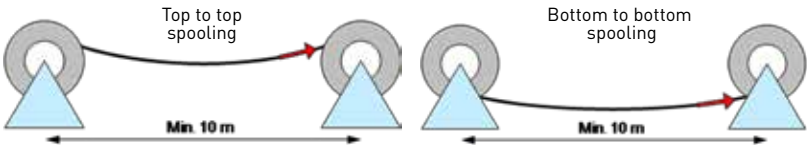

**Fig. 1 Hose re-spooling**

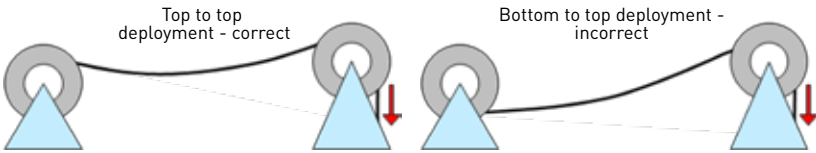

**Fig. 2 Hose deployment**

## 5 Possible causes of premature failure, and suggested preventative measures

### 5.1 Bending the hose below the minimum bend radius

This is most likely to occur if the end fitting is not supported during lifting, a support sling wrongly positioned, or the hose being pulled around a tight corner. It is important that hose should not be bent close to the end fittings. The straight section should be at least two times the outside diameter of the hose before it starts to bend.

Bend restrictors, lifting clamps and containment grips are useful accessories that help to reduce this type of handling problem.

### 5.2 Damage of the hose cover

Polyflex ColorGard™ extra thick, dual color cover significantly reduces the risk of exposing the reinforcing wires. If the outer black cover has been abraded to the point that the “early warning” red inner cover can be seen, but the wire reinforcement has not been exposed, the assembly is still fit for use but shall be scheduled for inspection. Alternatively, a repair according to section 8.1.1 may be considered.

If the hose cover is damaged to the extent that the reinforcing wires are exposed, localized corrosion of the wires could occur causing a progressive reduction in burst pressure, and ultimately failure.

If used subsea, a damaged cover will allow water to ingress into the carcass of the hose and could cause the corrosion of the wire reinforcement and/or collapse of the core tube.

It is strongly recommended to immediately remove from service any hose assembly with exposed wires. See also section 8.1.2 for details. A Parker Polyflex specialized testing facility should be contacted and the procedure described in section 7.1 shall be followed.

### 5.3 Kinked, crushed or twisted hose

If a visible distortion of the hose occurred (kinked, crushed, twisted) it will have an impact on the function and lifetime of the hose. Reduction of burst pressure and external collapse pressure could result in a sudden failure of the hose assembly. This distortion can be caused by a high tensile load or other factors.

Maintaining pressure in the hose will significantly reduce the risk of such distortion occurring.

# PFDE-ES28: Handling, Maintenance and Inspection of *polyflex* Offshore Hoses

## 5.4 Chemical attack or aging of the core tube

The use of chemicals at differing concentrations and/or temperatures can have a major effect on the life of a hose assembly and may cause dramatic hose failure. It is important to reference the chemical compatibility chart in the appendix of this document and keep the temperatures and concentrations within the specified limits.

### Note:

It is critical that the hose is thoroughly flushed with water after each use.

If the hose is not flushed, the concentration of the fluid that is left in the assembly can increase and cause localised failure of the core tube.

## 5.5 Damage or corrosion of the end fitting

Incorrect handling or insufficient flushing after use could result in damage or corrosion of the end fitting. This will make connection difficult, probably cause leakage, and could result in sudden failure of the connection.

## 5.6 Flow rates

Depending on the abrasive properties of the fluid, high flow rates can result in erosion in the core tube or in the bore of the end fitting.

The maximum recommended flow rate is 15 m/sec, although much higher rates have been used short term with non abrasive fluids.

### Note:

The condition of the core tube and end fittings are checked as part of the full inspection.

## 6 Routine in-field pre-job and post-job maintenance, inspection and testing

### 6.1 Routine in-field pre-job maintenance, inspection and testing

The operator shall visually inspect the hose assembly during every deployment. If any of the following conditions are found the hose shall be removed from service and scheduled for inspection.

- Damage to the outer cover which exposes the reinforcing wires.
- Kinked, crushed, or twisted hose.
- Reduction in the outside diameter of the hose.
- Blistered, soft, degraded, or loose outer cover.
- Cracked, damaged, or badly corroded fittings.

If in doubt, contact the original supplier or a Parker Polyflex specialized testing facility for advice.

Regular in-field pressure testing, (normally required after attaching connectors prior to hose deployment), should be restricted to a test pressure of  $1,1 \times$  actual operating pressure, or the maximum stated working pressure of the hose assembly.

Prior to all pressure testing it must be ensured that all air is purged out of the hose. Failure to do so may result in core tube failure. To control that all air is removed it is sufficient to observe that the fluid flow leaving the hose is steady and constant for minimum of 5 minutes without any air bubbles or pulsations.



# PFDE-ES28: Handling, Maintenance and Inspection of *polyflex* Offshore Hoses

## 6.2 Routine in-field post-job maintenance, inspection and testing

On completion of each operation both inside and outside hose surfaces should be flushed/cleaned with sufficient clean water to ensure that all chemicals or residues are fully removed from the hose assembly.

The operator shall visually inspect the hose assembly during every recovery. If any of the following conditions are found the assembly shall be removed from service and scheduled for inspection.

- Damage to the outer cover which exposes the reinforcing wires.
- Kinked, crushed, or twisted hose.
- Reduction in the outside diameter of the hose.
- Blistered, soft, degraded, or loose outer cover.
- Cracked, damaged, or badly corroded fittings.

If in doubt, contact the original supplier or a Parker Polyflex specialized testing facility for advice.

## 6.3 Recertification of hose assemblies

Parker Polyflex recommend that all hose assemblies shall be returned to the original supplier or a Parker Polyflex specialized testing facility at least once a year for full inspection/recertification.

The supplier will issue a report detailing the condition of the assembly, and recommend recertification, repair, or replacement.

## 7 Procedure for full inspection

In addition to the standard marking (WP, month and year of production, hose assembly manufacturer and serial number) all hose assemblies will be marked with the recertification date (RECERT. MM/YYYY).

It is the responsibility of the purchaser to track the location of the hose assembly and the responsibility of the supplier to inform the purchaser a month before the hose assembly is due for full inspection/recertification.

Parker Polyflex have trained and certified specialized facilities and their personnel to assemble, inspect, test, repair and recertify hose assemblies.

Hose management is an essential part of the service they provide.

The history of each assembly must be logged showing the results of previous inspections and any repairs.

### 7.1 Customer pre-dispatch procedure before returning a hose assembly for inspection/repair

- The object is to make sure the hose assembly can be safely handled and the condition of the assembly will justify the transportation and inspection costs.
- The chosen inspection facility should be contacted if doubtful about any of the points below.
- Check and record assembly serial number (send information to test facility).
- Assembly must be free of chemical residues inside and outside (could result in refusal to handle returned assembly).
- Report on any findings out of section 6.1
- Method of transport, size and weight, (long length hose assemblies on drums or reels may require special handling equipment such as drums and re-spooling machinery).
- Customer will receive a budget price for inspection based on the information given by the end user.

# PFDE-ES28: Handling, Maintenance and Inspection of *polyflex* Offshore Hoses

## 7.2 Full inspection of the returned hose assembly includes the following:

- Safety inspection, condition of assembly as received.
  - Check for chemical residue inside and outside (may require flushing or cleaning).
  - Assembly serial number (check assembly history including previous repairs).
- External inspection
- Internal inspection
- Inspection report

### 7.2.1 External inspection

- Damage to the outer cover (abrasion, incorrect routing)
- Exposed reinforcing wires. (damaged outer cover)
- Kinked, crushed, or twisted hose. (high tensile loading, incorrect routing)
- Reduction in the outside diameter of the hose (high tensile loading with no pressure)
- Blistered, soft, degraded, or loose outer cover. (chemical attack, leaking fitting, permeation or high temperature)
- Cracked, damaged, or badly corroded fittings (chemical attack, poor handling, old hose assembly)
- Damage or wear on fitting threads (poor handling, old hose assembly)
- Condition of containment grips / clamps. (abrasion, frayed wires, distortion)

### 7.2.2 Internal inspection

Internal inspection shall be done with an endoscope.

- Check for damage to bore of fittings, cracks, severe abrasion, corrosion.
- Check condition of core tube at the back of fittings (critical area).
- Scope maximum length of the core tube possible. Recommended minimum is 10 m both sides.

- Hose assemblies shorter than 20 m should be scoped on the complete length.
- Look for uneven surface (sign of wire fatigue, abrasion, chemical attack).

### 7.2.3 Inspection report

The testing facility will advise on the overall condition of the hose and end connections.

Customer will receive detailed report of the findings, including recommended actions:

- repair
- recertification
- scrapping

## 8 Procedure for repair and recertification

### 8.1 Repair

It is recommended, that all repairs are done by certified specialized testing facilities. Some repairs (see examples below) could be done in field. Be sure to maintain safety requirements.

#### 8.1.1 Twisted hose, hose with reduced O.D., flattened hose

A hose with signs of twisting or deformation will need to be unreeled, as straight as possible, from the winch/drum in a safe environment and pressurized to working pressure for at least 1 hour and then pressure released. The hose shall be re-inspected to see if the hose has returned to its "untwisted, undistorted" original shape. If so, the hose should be again pressurized before rewinding back onto the winch/drum. Any sections of hose still misshapen should be cut out of the assembly.

# PFDE-ES28: Handling, Maintenance and Inspection of *polyflex* Offshore Hoses

## 8.1.2 Hose with cover damage

- No reinforcement wires exposed.

Temporary solution, the damaged area can be cleaned and protected by wrapping with a strong adhesive “duct / riggers” tape. If abraded to the point where the red ColorGard is visible, the damaged area should be thoroughly cleaned with mild solvent, a thin plastic sheet wrapped around the hose to form a mould. A two pack polyurethane mixture can then be poured into the mould and allowed to set. Remove mould after the polyurethane is set.

- Reinforcement wires exposed.

It is strongly recommended to remove the hose assembly from service immediately. Any ingress of water into hose carcass will initiate corrosion of the reinforcement wire. It is difficult to estimate the rate of corrosion. At best, the hose could function for months, at worst, possibly less than one week. It is also possible that the core tube could have collapsed if the external pressure acting within the carcass is greater than internal pressure within the hose.

In any case, the lifetime of the hose assembly will be significantly reduced, and the hose assembly shall be immediately scheduled for inspection at certified specialized testing facility.

Decision to further use a hose assembly with exposed wire shall be based on a proof pressure test for 1,1× maximum working pressure of the hose assembly. This test shall be conducted prior to every further job.

Repair of such a hose assembly is possible, but it will include cutting out the section of the hose, where the wires have been subjected to water. Obviously, this will require new fittings to be crimped and hose assembly to be proof pressure tested. Procedure for proof pressure testing in this case is specified in the assembly instructions for the appropriate hose type.

After successfully passing pressure test, hose assembly shall be permanently marked with the new recertification date (see section 7).

The testing facility will recommend if the condition of the hose warrants the cost of assembling new fittings, joining the lengths together and proof testing.

## 8.2 Recertification

Recertification shall include full inspection acc. to section 7.2 and a hydrostatic pressure test.

Unless otherwise agreed between customer and test facility, test conditions are:

Test pressure = 1.5× maximum working pressure of hose assembly. Allow for at least 30 minutes stabilization time before starting recording pressure decay.

Pressure hold time = 1 hour

Pressure decrease of maximum 5% is allowed.

After successfully passing pressure test, hose assembly shall be permanently marked with the new recertification date (see section 7).

The maximum number of pressurizations to 1.5× maximum working pressure is limited to 20.

### Note:

The 20 × 1.5 WP pressurizations is likely to be a combination of annual inspections, re-ending damaged fittings, or cutting off damaged hose. Example 1 – undamaged hose and fittings tested once a year give an estimated lifetime of 20 years. Example 2 - after 5 years, – fitting re-ended 4 times, hose damaged 3 times, 5× annual pressurizations at 1.5 x WP (tip, re-ending of both fittings would only require one pressure test) result in the total number of pressurizations at 1.5 × WP of 12.

# PFDE-ES28: Handling, Maintenance and Inspection of *polyflex* Offshore Hoses

## Appendix 1: Chemical Resistance Chart

The below chart contains chemical resistance information for Polyamide 11 (Nylon 11) and Fluoropolymer.

These are the most common core tube materials used for Parker Polyflex oil & gas hoses. Please refer to the hose datasheets for more detailed information.

### Rating Codes

E	Excellent	Good to excellent. Little or no swelling, tensile or surface change. Preferred choice.
A	Good	Good to excellent. Little or no swelling, tensile or surface change. Limitations with temperature and type of fluid.
B	Limited	Marginal or conditional. Noticeable effects but not necessary indicating lack of serviceability. Further testing is suggested for specific application. Very long-term effects.
X	Unsatisfactory	Poor or unsatisfactory. Not recommended without extensive and realistic testing.
-		Indicates that this was not tested.
*	Swelling	Increase of volume of material, due to absorption of a solvent.

### Material Code for Hose Core Tube

N Polyamide

M Coextruded core tube with Fluoropolymer inner liner

For waterblast and general hydraulic hoses, see page F-10

### Notes on Chemical Resistance Table

The chemical resistance table is a simplified rating tabulation based on immersion tests. Higher temperatures tend to reduce ratings. Since final selection depends on pressure, fluid, ambient temperature and many other factors not known to Parker Hannifin, no performance guarantee is expressed or implied.

The indications do not imply any compliance with standards and regulations and do not refer to possible changes of colour, taste or smell.

Some hose applications must take into account legal and insurance regulations. The chemical resistance indicated does not express or imply approval by certain institutions.

Chemical resistance does not imply low permeation rates.

For gas applications, the cover may be pin-pricked. Pin-pricking reduces the potential of cover blistering due to permeation. However, pin-pricked wire reinforced hoses are not suitable for subsea use. Parker Polyflex wire reinforced hoses may be used without pin-pricking. In this case, time of permanent use with gas should be limited to 30 days. Hoses with ColorGard will not be pin-pricked. No special precautions on decompression rate are required, however, explosive decompression rate (>200 bar/sec) is not recommended. Note that hoses with coextruded core tube with Fluoropolymer inner liner are not recommended for gas applications.

For fluids, not listed or for advice on particular applications, please contact Parker Hannifin, Polyflex Division in Lampertheim, Germany.

# PFDE-ES28: Handling, Maintenance and Inspection of *polyflex* Offshore Hoses

Hose  
A

Chemical	Concentration	N					M
		20°C (68°F)	40°C (104°F)	60°C (140°F)	90°C (194°F)	100°C (212°F)	
Acetaldehyde		A	B	X	X	A	
Acetic Acid	5%	A	A	A	B	E	
Acetic Acid	10%	A	A	B	X	E	
Acetic Acid	50%	B	X	X	X	E	
Acetic Anhydride		B	X	X	X	E	
Acetone	Pure	A	A	B	X	A	
Acetylene		A	A	A	—	A	
Air		A	A	A	A	A	
Aluminium Sulfate	Saturated Solution	A	A	A	A	A	
Ammonia	Liquid or Gas	A	A	A	X	A	
Ammonium Chloride		A	A	A	—	A	
Ammonium Hydroxide	Concentrated	A	A	A	A	A	
Ammonium Nitrate		A	A	A	A	A	
Ammonium Sulfate	Saturated Solution	A	A	B	—	E	
Amyl Acetate		A	A	A	B	A	
Aniline		B*	X	X	X	E	
Asphalt		A	A	A	A	A	
Barium Chloride	Saturated Solution	A	A	A	A	A	
Benzaldehyde		A	B	X	X	E	
Benzene		A	A*	B	X	E	
Butane		A	A	A	A	A	
Butyl Alcohol		A*	B	X	X	E	
Calcium Arsenate		A	A	A	—	A	
Calcium Chloride	Saturated Solution	A	A	A	A	A	
Calcium Nitrate		A	A	A	—	A	
Camphor		A	—	—	—	A	
Carbon Dioxide		A	A	A	A	A	
Carbon Monoxide		A	A	A	A	A	
Carbon Disulfide		A*	B*	B	X	A	
Carbon Tetrachloride		X	X	X	X	A	
Cement Slurries		A	A	A	—	A	
Chlorinated Solvents		B	X	X	X	E	
Chloroform		B	X	X	X	E	
Chromic Acid		X	X	X	X	E	
Citric Acid	Saturated Solution	A	A	B	X	E	
Copper Sulfate		A	A	A	A	A	
Cyclohexane		A	A	A	B	A	
Cyclohexanol		A	B	X	X	E	

Fittings  
B

Adapters & Valves  
C

Quick Couplings  
D

Accessories  
E

General Technical  
F

See page F-26 for instructions on using this chart

# PFDE-ES28: Handling, Maintenance and Inspection of *polyflex* Offshore Hoses

Chemical	Concentration	N				M
		20°C (68°F)	40°C (104°F)	60°C (140°F)	90°C (194°F)	100°C (212°F)
Cyclohexanone		A	B	X	X	E
Diammonium Phosphate		A	A	B	—	E
Dichloroethylene		B	X	X	X	E
Diesel		A	A	A	A	A
Diester Oils		A	A	A	B	A
Diethanolamine	20%	A	A*	A*	B	A
Diethyl Ether		A	—	—	—	E
Dioctylphthalate		A	A	A	B	A
Ethanol	Pure	A*	B	B	X	E
Ethyl Acetate		A	A	A	—	A
Ethylene Glycol		A*	A*	B	X	E
Ethylene Oxide		A	A	X	X	E
Fatty Acid Esters		A	A	A	A	A
Formaldehyde	Technical	A	B	X	X	E
Formic Acid	10%	X	X	X	X	E
Furfuryl Alcohol		A	A*	B	X	E
Gas [Coal]		A	A	—	—	A
Gasoline (High Octane)		A	A	A*	—	A
Glucose		A	A	A	A	A
Glycerine	Pure	A	A	B	X	E
Glycol		A	A	B	X	A
Heptane		A	A	A*	—	A
Hexane		A	A	A	A	A
Hydrogen		A	A	A	A	A
Hydraulic Fluid (petroleum base)		A	A	A	A	A
Hydraulic Fluid (phosphate ester base)		A	A	A	B	A
Hydraulic Fluid (water base)		A	A	A	A	A
Hydrogen Peroxide	20%	A	B	—	—	E
Hydrochloric Acid	15%	A	B	X	X	E
Hydrochloric Acid	28%	X	X	X	X	E
Hydrochloric Acid	37%	X	X	X	X	A
Hydrofluoric Acid	3%	A	B	X	X	E
Isocyanates		B	X	X	X	E
Isooctane		A	A	A	A	A
Isopropyl Alcohol		A	B	X	X	E
Kerosene		A	A	A*	B	A
Lactic Acid		A	A	A	B	E

See page F-26 for instructions on using this chart

# PFDE-ES28: Handling, Maintenance and Inspection of *polyflex* Offshore Hoses

Chemical	Concentration	N				M
		20°C (68°F)	40°C (104°F)	60°C (140°F)	90°C (194°F)	100°C (212°F)
LP Gas		A	A	A	A	E
Magnesium Chloride	50%	A	A	A	A	A
Mercury		A	A	A	A	A
Methane		A	A	A	A	E
Methanol	Pure	A	B	B*	X	E
Methyl-Cellosolve		A	A	A	X	A
Methyl Acetate		A	A	A	—	A
Methyl Bromide		A	X	X	X	E
Methyl Chloride		A	X	X	X	E
Methyl Sulfate		A	B	—	—	E
Methyl Ethyl Ketone		A	A	B	X	—
Methyl Isobutyl Ketone		A	A	B	X	E
Methylene Chloride		X	X	X	X	A
Monochlorobenzene		B	X	X	X	A
Naphta		A	A	A	—	A
Naphtalene		A	A	A	B	A
Natural Gas		A	A	A	A	E
Nitric Acid		X	X	X	X	A
Nitrobenzene		B	X	X	X	A
Nitrogen Gas		A	A	A	A	E
Oil Crude		A	A	A	B	A
Oils Refined		A	A	A	B	A
Oleic Acid		A	A	A	B	A
Oxalic Acid		A	A	B	X	E
Oxygen Gas		A	A	B	X	A
Perchloric Acid		B	X	X	X	B
Perchloroethylene		B	X	X	X	E
Petroleum Ether		A	A	A	B	E
Phosphoric Acid	50%	A	B	X	X	E
Picric Acid		B	X	X	X	E
Potassium Carbonate		A	A	B	X	E
Potassium Chloride		A	A	B	X	E
Potassium Hydroxide	50%	A	B	X	X	E
Potassium Nitrate		A*	B*	X	X	E
Potassium Sulfate		A	A	A	A	A
Propane		A	A	A	A	A
Propylen Glycol		A	B	X	X	A

See page F-26 for instructions on using this chart

Hose  
A

Fittings  
B

Adapters & Valves  
C

Quick Couplings  
D

Accessories  
E

**F** General Technical

# PFDE-ES28: Handling, Maintenance and Inspection of *polyflex* Offshore Hoses

Chemical	Concentration	N				M
		20°C (68°F)	40°C (104°F)	60°C (140°F)	90°C (194°F)	100°C (212°F)
Pydraul F9		A	A	A	—	A
Pyridine	Pure	B	X	X	X	E
Sodium Borate		A	A	A	—	A
Sodium Carbonate	Saturated Solution	A	A	B	X	E
Sodium Chloride	Saturated Solution	A	A	A	A	A
Sodium Hydroxide	50%	A	B	X	X	E
Sodium Hypochlorite	Concentrated	B	X	X	X	E
Sodium Hypochlorite	Dilute Commercial	A	B	X	X	E
Sodium Sulfide		A	A	B	—	E
Stearin		A	B	B	—	E
Stearic Acid		A	A	A	B	A
Styrene Monomer		A	A*	—	—	E
Sulphur Dioxide		B	X	X	X	A
Sulphur Hexafluoride Gas		A	A	A	A	A
Sulphuric Acid	10%	A	B	X	X	A
Sulfic Anhydride		B	X	X	X	E
Tartaric Acid		A	A	A	B	A
Tetraethyl Lead		A	—	—	—	E
Tetrahydrofurane		A	A	B	X	E
Toluene		A	A*	B	B	E
Trichloroethane		B	X	X	X	E
Trichloroethylene		B	X	X	X	E
Tricresyl Phosphate		A	A	A	B	A
Tributyl Phosphate		A	A	A	B	A
Trisodium Phosphate		A	A	A	A	A
Triphenyl Phosphate		A	A	B	—	A
Turpentine		A	A	B	—	A
Urea		A	A	B	B	E
Uric Acid		A	A	A	B	A
Vinegar		A	A	A	—	A
Water		A	A	A	A	A
Water Glycols		A	A	A	B	A
Water, Sea		A	A	A	A	A
Water, Soda		A	A	A	A	A
Xylene		A	A*	B	B	E
Zinc Chloride		A	A	B	X	E

See page F-26 for instructions on using this chart



# PFDE-ES28: Handling, Maintenance and Inspection of *polyflex* Offshore Hoses

## Appendix 2: Data for Tensile Loading and Weights of Polyflex Hoses

Note that all below values of tensile forces include the own weight of the hoses. Pressurized hose can take higher tensile load, it will elongate less. All values below have been confirmed by testing. In all cases the hoses will not elongate more than 10%.

2448N-32V80	Pressure [bar]	0	100 and above		
	Max. tensile force [kN]	15	20		
2580N-32V80	Pressure [bar]	0	100	200	300 and above
	Max. tensile force [kN]	25	30	35	40
2240N-48V80	Pressure [bar]	0	100 and above		
	Max. tensile force [kN]	15	20		
2440N-48V80	Pressure [bar]	0	100	200 and above	
	Max. tensile force [kN]	30	40	50	
2640N-48V80	Pressure [bar]	0	100	200	350 and above
	Max. tensile force [kN]	30	40	50	100

In the table below some figures are put together for information.

	Hose I.D. (mm)	Hose O.D. (mm)	Hose weight in air empty (kg/m)	Hose weight in air, full of water (kg/m)	Hose weight in water empty (kg/m)	Hose weight in water full of water (kg/m)
2448N-32V80	50.5	80.5	8.5	10.5	3.3	5.3
2580N-32V80	50.5	84.5	9.4	11.5	3.7	5.7
2240N-48V80	75.0	114.0	11.5	16.0	1.1	5.6
2440N-48V80	75.0	122.0	18.7	23.2	6.7	11.3
2640N-48V80	75.0	130.0	27.5	32.0	14.0	18.4

**1st Example:** No pressure. 300 m length of 2240N-48V80 shall be deployed. Hose weight in water, full of water,  $5,6 \text{ kg/m} \times 300 \text{ m} = 1680 \text{ kg}$ . Max tensile force is 15 kN, therefore a 300m length is too heavy to deploy in these conditions.

**2nd Example:** Pressure 100 bar. 300 m length of 2240N-48V80 shall be deployed. Hose weight in water, full of water,  $5,6 \text{ kg/m} \times 300 \text{ m} = 1680 \text{ kg}$  max. tensile force is 20 kN, so a 300 m length of 2240N-48V80 is OK to deploy when pressurized at 100 bar, and an additional weight of  $2000-1680=320 \text{ kg}$  may be added.

**NOTE:** Appendix 2 chemical charts are located in the on-line brochure "4900-PFDE-ES28", followed by Appendix 3. Choose the link below for immediate access.

TAKE ME TO 4900-PFDE-ES28

# Parker Safety Guide

## Parker Safety Guide for Selecting and Using Hose, Tubing, Fittings, Connectors, Conductors, Valves and Related Accessories



### Parker Safety Guide for Selecting and Using Hose, Tubing, Fittings and Related Accessories Publication No. 4400-B.1, Revised: October 2015, Rev A

**WARNING:** Failure or improper selection or improper use of hose, tubing, fittings, assemblies, valves, connectors, conductors or related accessories ("Products") can cause death, personal injury and property damage. Possible consequences of failure or improper selection or improper use of these Products include but are not limited to:

- Fittings thrown off at high speed.
- High velocity fluid discharge.
- Explosion or burning of the conveyed fluid.
- Electrocutation from high voltage electric powerlines.
- Contact with suddenly moving or falling objects that are controlled by the conveyed fluid.
- Injections by high-pressure fluid discharge.
- Dangerously whipping Hose.
- Tube or pipe burst.
- Weld joint fracture.
- Contact with conveyed fluids that may be hot, cold, toxic or otherwise injurious.
- Sparking or explosion caused by static electricity buildup or other sources of electricity.
- Sparking or explosion while spraying paint or flammable liquids.
- Injuries resulting from inhalation, ingestion or exposure to fluids.

**Before** selecting or using any of these Products, it is important that you read and follow the instructions below. No product from any division in Parker Fluid Connectors Group is approved for in-flight aerospace applications. For hoses and fittings used in in-flight aerospace applications, please contact Parker Aerospace Group.

### 1.0 GENERAL INSTRUCTIONS

1.1 Scope: This safety guide provides instructions for selecting and using (including assembling, installing, and maintaining) these Products. For convenience, all rubber and/or thermoplastic products commonly called "hose" or "tubing" are called "Hose" in this safety guide. Metallic tube or pipe are called "tube". All assemblies made with Hose are called "Hose Assemblies". All assemblies made with Tube are called "Tube Assemblies".

All products commonly called "fittings", "couplings" or "adapters" are called "Fittings". Valves are fluid system components that control the passage of fluid. Related accessories are ancillary devices that enhance or monitor performance including crimping, flaring, flanging, presetting, bending, cutting, deburring, swaging machines, sensors, tags, lockout handles, spring guards and associated tooling. This safety guide is a supplement to and is to be used with the specific Parker publications for the specific Hose, Fittings and Related Accessories that are being considered for use. Parker publications are available at [www.parker.com](http://www.parker.com). SAE J1273 ([www.sae.org](http://www.sae.org)) and ISO 17165-2 ([www.ansi.org](http://www.ansi.org)) also provide recommended practices for hydraulic Hose Assemblies, and should be followed.

1.2 Fail-Safe: Hose, Hose Assemblies, Tube, Tube Assemblies and Fittings can and do fail without warning for many reasons. Design all systems and equipment in a fail-safe mode, so that failure of the Hose, Hose Assembly, Tube, Tube Assembly or Fitting will not endanger persons or property.

1.3 Distribution: Provide a copy of this safety guide to each person responsible for selecting or using Hose, Tube and Fitting products. Do not select or use Parker Hose, Tube or Fittings without thoroughly reading and understanding this safety guide as well as the specific Parker publications for the Products.

1.4 User Responsibility: Due to the wide variety of operating conditions and applications for Hose, Tube and Fittings, Parker does not represent or warrant that any particular Hose, Tube or Fitting is suitable for any specific end use system. This safety guide does not analyze all technical parameters that must be considered in selecting a product. The user, through its own analysis and testing, is solely responsible for:

- Making the final selection of the Products.
- Assuring that the user's requirements are met and that the application presents no health or safety hazards.
- Following the safety guide for Related Accessories and being trained to operate Related Accessories.
- Providing all appropriate health and safety warnings on the equipment on which the Products are used.
- Assuring compliance with all applicable government and industry standards.

1.5 Additional Questions: Call the appropriate Parker technical service department if you have any questions or require any additional information.

See the Parker publication for the Products being considered or used, or call 1-800-CPARKER, or go

# Parker Safety Guide

to [www.parker.com](http://www.parker.com), for telephone numbers of the appropriate technical service department.

## 2.0 HOSE, TUBE & FITTINGS SELECTION INSTRUCTIONS

2.1 Electrical Conductivity: Certain applications require that the Hose be nonconductive to prevent electrical current flow. Other applications require the Hose and the Fittings and the Hose/Fitting interface to be sufficiently conductive to drain off static electricity. Extreme care must be exercised when selecting Hose, Tube and Fittings for these or any other applications in which electrical conductivity or nonconductivity is a factor.

The electrical conductivity or nonconductivity of Hose, Tube and Fittings is dependent upon many factors and may be susceptible to change. These factors include but are not limited to the various materials used to make the Hose and the Fittings, Fitting finish (some Fitting finishes are electrically conductive while others are nonconductive), manufacturing methods (including moisture control), how the Fittings contact the Hose, age and amount of deterioration or damage or other changes, moisture content of the Hose at any particular time, and other factors.

The following are considerations for electrically nonconductive and conductive Hose. For other applications consult the individual catalog s and the appropriate industry or regulatory standards for proper selection.

2.1.1 Electrically Nonconductive Hose: Certain applications require that the Hose be nonconductive to prevent electrical current flow or to maintain electrical isolation. For applications that require Hose to be electrically nonconductive, including but not limited to applications near high voltage electric lines, only special nonconductive Hose can be used. The manufacturer of the equipment in which the nonconductive Hose is to be used must be consulted to be certain that the Hose, Tube and Fittings that are selected are proper for the application. Do not use any Parker Hose or Fittings for any such application requiring nonconductive Hose, including but not limited to applications near high voltage electric lines or dense magnetic fields, unless (i) the application is expressly approved in the Parker technical publication for the product, (ii) the Hose is marked "nonconductive", and (iii) the manufacturer of the equipment on which the Hose is to be used specifically approves the particular Parker Hose, Tube and Fittings for such use.

2.1.2 Electrically Conductive Hose: Parker manufactures special Hose for certain applications that require electrically conductive Hose. Parker manufactures special Hose for conveying paint in airless paint spraying applications. This Hose is labeled "Electrically Conductive Airless Paint Spray Hose" on its layline and packaging. This Hose must

be properly connected to the appropriate Parker Fittings and properly grounded in order to dissipate dangerous static charge buildup, which occurs in all airless paint spraying applications. Do not use any other Hose for airless paint spraying, even if electrically conductive. Use of any other Hose or failure to properly connect the Hose can cause a fire or an explosion resulting in death, personal injury, and property damage. All hoses that convey fuels must be grounded.

Parker manufactures a special Hose for certain compressed natural gas ("CNG") applications where static electricity buildup may occur. Parker CNG Hose assemblies comply with the requirements of ANSI/IAS NGV 4.2; CSA 12.52, "Hoses for Natural Gas Vehicles and Dispensing Systems" ([www.ansi.org](http://www.ansi.org)). This Hose is labeled "Electrically Conductive for CNG Use" on its layline and packaging. This Hose must be properly connected to the appropriate Parker Fittings and properly grounded in order to dissipate dangerous static charge buildup, which occurs in, for example, high velocity CNG dispensing or transfer. Do not use any other Hose for CNG applications where static charge buildup may occur, even if electrically conductive. Use of other Hoses in CNG applications or failure to properly connect or ground this Hose can cause a fire or an explosion resulting in death, personal injury, and property damage. Care must also be taken to protect against CNG permeation through the Hose wall. See section 2.6, Permeation, for more information. Parker CNG Hose is intended for dispenser and vehicle use within the specified temperature range. Parker CNG Hose should not be used in confined spaces or unventilated areas or areas exceeding the specified temperature range. Final assemblies must be tested for leaks. CNG Hose Assemblies should be tested on a monthly basis for conductivity per ANSI/IAS NGV 4.2; CSA 12.52.

Parker manufactures special Hose for aerospace in-flight applications. Aerospace in-flight applications employing Hose to transmit fuel, lubricating fluids and hydraulic fluids require a special Hose with a conductive inner tube. This Hose for in-flight applications is available only from Parker's Stratoflex Products Division. Do not use any other Parker Hose for in-flight applications, even if electrically conductive. Use of other Hoses for in-flight applications or failure to properly connect or ground this Hose can cause a fire or an explosion resulting in death, personal injury and property damage. These Hose assemblies for in-flight applications must meet all applicable aerospace industry, aircraft engine and aircraft requirements.

2.2 Pressure: Hose, Tube and Fitting selection must be made so that the published maximum working pressure of the Hose, Tube and Fittings are equal to or greater than the maximum system pressure. The maximum working pressure of a

Hose  
A  
Fittings  
B  
Adapters & Valves  
C  
Quick Couplings  
D  
Accessories  
E  
General Technical  
F

# Parker Safety Guide

Hose, or Tube Assembly is the lower of the respective published maximum working pressures of the Hose, Tube and the Fittings used. Surge pressures or peak transient pressures in the system must be below the published maximum working pressure for the Hose, Tube and Fitting. Surge pressures and peak pressures can usually only be determined by sensitive electrical instrumentation that measures and indicates pressures at millisecond intervals. Mechanical pressure gauges indicate only average pressures and cannot be used to determine surge pressures or peak transient pressures. Published burst pressure ratings for Hose is for manufacturing test purposes only and is no indication that the Product can be used in applications at the burst pressure or otherwise above the published maximum recommended working pressure.

**2.3 Suction:** Hoses used for suction applications must be selected to insure that the Hose will withstand the vacuum and pressure of the system. Improperly selected Hose may collapse in suction application.

**2.4 Temperature:** Be certain that fluid and ambient temperatures, both steady and transient, do not exceed the limitations of the Hose, Tube, Fitting and Seals. Temperatures below and above the recommended limit can degrade Hose, Tube, Fittings and Seals to a point where a failure may occur and release fluid. Tube and Fittings performances are normally degraded at elevated temperature. Material compatibility can also change at temperatures outside of the rated range. Properly insulate and protect the Hose Assembly when routing near hot objects (e.g. manifolds). Do not use any Hose in any application where failure of the Hose could result in the conveyed fluids (or vapors or mist from the conveyed fluids) contacting any open flame, molten metal, or other potential fire ignition source that could cause burning or explosion of the conveyed fluids or vapors.

**2.5 Fluid Compatibility:** Hose, and Tube Assembly selection must assure compatibility of the Hose tube, cover, reinforcement, Tube, Plating and Seals with the fluid media used. See the fluid compatibility chart in the Parker publication for the product being considered or used. This information is offered only as a guide. Actual service life can only be determined by the end user by testing under all extreme conditions and other analysis.

Hose, and Tube that is chemically compatible with a particular fluid must be assembled using Fittings and adapters containing likewise compatible seals. Flange or flare processes can change Tube material properties that may not be compatible with certain requirements such as NACE

**2.6 Permeation:** Permeation (that is, see through the Hose or Seal) will occur from inside the Hose or Fitting to outside when Hose or Fitting is used

with gases, liquid and gas fuels, and refrigerants (including but not limited to such materials as helium, diesel fuel, gasoline, natural gas, or LPG). This permeation may result in high concentrations of vapors which are potentially flammable, explosive, or toxic, and in loss of fluid. Dangerous explosions, fires, and other hazards can result when using the wrong Hose for such applications. The system designer must take into account the fact that this permeation will take place and must not use Hose or Fitting if this permeation could be hazardous. The system designer must take into account all legal, government, insurance, or any other special regulations which govern the use of fuels and refrigerants. Never use a Hose or Fitting even though the fluid compatibility is acceptable without considering the potential hazardous effects that can result from permeation through the Hose or Tube Assembly. Permeation of moisture from outside the Hose or Fitting to inside the Hose or Fitting will also occur in Hose or Tube assemblies, regardless of internal pressure. If this moisture permeation would have detrimental effects (particularly, but not limited to refrigeration and air conditioning systems), incorporation of sufficient drying capacity in the system or other appropriate system safeguards should be selected and used. The sudden pressure release of highly pressurized gas could also result in Explosive Decompression failure of permeated Seals and Hoses.

**2.7 Size:** Transmission of power by means of pressurized fluid varies with pressure and rate of flow. The size of the components must be adequate to keep pressure losses to a minimum and avoid damage due to heat generation or excessive fluid velocity.

**2.8 Routing:** Attention must be given to optimum routing to minimize inherent problems (kinking or flow restriction due to Hose collapse, twisting of the Hose, proximity to hot objects or heat sources). For additional routing recommendations see SAE J1273 and ISO 17165-2. Hose Assemblies have a finite life and should be installed in a manner that allows for ease of inspection and future replacement. Hose because of its relative short life, should not be used in residential and commercial buildings inside of inaccessible walls or floors, unless specifically allowed in the product literature. Always review all product literature for proper installation and routing instructions.

**2.9 Environment:** Care must be taken to insure that the Hose, Tube and Fittings are either compatible with or protected from the environment (that is, surrounding conditions) to which they are exposed. Environmental conditions including but not limited to ultraviolet radiation, sunlight, heat, ozone, moisture, water, salt water, chemicals and air pollutants can cause degradation and premature failure.

# Parker Safety Guide

**2.10 Mechanical Loads:** External forces can significantly reduce Hose, Tube and Fitting life or cause failure. Mechanical loads which must be considered include excessive flexing, twist, kinking, tensile or side loads, bend radius, and vibration. Use of swivel type Fittings or adapters may be required to insure no twist is put into the Hose. Use of proper Hose or Tube clamps may also be required to reduce external mechanical loads. Unusual applications may require special testing prior to Hose selection.

**2.11 Physical Damage:** Care must be taken to protect Hose from wear, snagging, kinking, bending smaller than minimum bend radius and cutting, any of which can cause premature Hose failure. Any Hose that has been kinked or bent to a radius smaller than the minimum bend radius, and any Hose that has been cut or is cracked or is otherwise damaged should be removed and discarded. Fittings with damages such as scratches on sealing surfaces and deformation should be replaced.

**2.12 Proper End Fitting:** See instructions 3.2 through 3.5. These recommendations may be substantiated by testing to industry standards such as SAE J517 for hydraulic applications, or MIL-A-5070, AS1339, or AS3517 for Hoses from Parker's Stratoflex Products Division for aerospace applications.

**2.13 Length:** When determining the proper Hose or Tube length of an assembly, be aware of Hose length change due to pressure, Tube length change due to thermal expansion or contraction, and Hose or Tube and machine tolerances and movement must be considered. When routing short hose assemblies, it is recommended that the minimum free hose length is always used. Consult the hose manufacturer for their minimum free hose length recommendations. Hose assemblies should be installed in such a way that any motion or flexing occurs within the same plane.

**2.14 Specifications and Standards:** When selecting Hose, Tube and Fittings, government, industry, and Parker specifications and recommendations must be reviewed and followed as applicable.

**2.15 Hose Cleanliness:** Hose and Tube components may vary in cleanliness levels. Care must be taken to insure that the Hose and Tube Assembly selected has an adequate level of cleanliness for the application.

**2.16 Fire Resistant Fluids:** Some fire resistant fluids that are to be conveyed by Hose or Tube require use of the same type of Hose or Tube as used with petroleum base fluids. Some such fluids require a special Hose, Tube, Fitting and Seal, while a few fluids will not work with any Hose at all. See instructions 2.5 and 1.5. The wrong Hose, Tube, Fitting or Seal may fail after a very short service. In addition, all liquids but pure water may burn

fiercely under certain conditions, and even pure water leakage may be hazardous.

**2.17 Radiant Heat:** Hose and Seals can be heated to destruction without contact by such nearby items as hot manifolds or molten metal. The same heat source may then initiate a fire. This can occur despite the presence of cool air around the Hose or Seal. Performance of Tube and Fitting subjected to the heat could be degraded.

**2.18 Welding or Brazing:** When using a torch or arc welder in close proximity to hydraulic lines, the hydraulic lines should be removed or shielded with appropriate fire resistant materials. Flame or weld spatter could burn through the Hose or Seal and possibly ignite escaping fluid resulting in a catastrophic failure. Heating of plated parts, including Hose Fittings and adapters, above 450°F (232°C) such as during welding, brazing or soldering may emit deadly gases. Any elastomer seal on fittings shall be removed prior to welding or brazing, any metallic surfaces shall be protected after brazing or welding when necessary. Welding and brazing filler material shall be compatible with the Tube and Fitting that are joined.

**2.19 Atomic Radiation:** Atomic radiation affects all materials used in Hose and Tube assemblies. Since the long-term effects may be unknown, do not expose Hose or Tube assemblies to atomic radiation. Nuclear applications may require special Tube and Fittings.

**2.20 Aerospace Applications:** The only Hose, Tube and Fittings that may be used for in-flight aerospace applications are those available from Parker's Stratoflex Products Division. Do not use any other Hose or Fittings for in-flight applications. Do not use any Hose or Fittings from Parker's Stratoflex Products Division with any other Hose or Fittings, unless expressly approved in writing by the engineering manager or chief engineer of Stratoflex Products Division and verified by the user's own testing and inspection to aerospace industry standards.

**2.21 Unlocking Couplings:** Ball locking couplings or other Fittings with quick disconnect ability can unintentionally disconnect if they are dragged over obstructions, or if the sleeve or other disconnect member, is bumped or moved enough to cause disconnect. Threaded Fittings should be considered where there is a potential for accidental uncoupling.

## 3.0 HOSE AND FITTINGS ASSEMBLY AND INSTALLATION INSTRUCTIONS

**3.1 Component Inspection:** Prior to assembly, a careful examination of the Hose and Fittings must be performed. All components must be checked for correct style, size, catalog number, and length. The Hose must be examined for cleanliness, obstructions, blisters, cover looseness, kinks, cracks, cuts

# Parker Safety Guide

or any other visible defects. Inspect the Fitting and sealing surfaces for burrs, nicks, corrosion or other imperfections. Do NOT use any component that displays any signs of nonconformance.

**3.2 Hose and Fitting Assembly:** Do not assemble a Parker Fitting on a Parker Hose that is not specifically listed by Parker for that Fitting, unless authorized in writing by the engineering manager or chief engineer of the appropriate Parker division. Do not assemble a Parker Fitting on another manufacturer's Hose or a Parker Hose on another manufacturer's Fitting unless (i) the engineering manager or chief engineer of the appropriate Parker division approves the Assembly in writing or that combination is expressly approved in the appropriate Parker literature for the specific Parker product, and (ii) the user verifies the Assembly and the application through analysis and testing. For Parker Hose that does not specify a Parker Fitting, the user is solely responsible for the selection of the proper Fitting and Hose Assembly procedures. See instruction 1.4.

To prevent the possibility of problems such as leakage at the Fitting or system contamination, it is important to completely remove all debris from the cutting operation before installation of the Fittings. The Parker published instructions must be followed for assembling the Fittings on the Hose. These instructions are provided in the Parker Fitting catalog for the specific Parker Fitting being used, or by calling 1-800-CPARKER, or at [www.parker.com](http://www.parker.com).

**3.3 Related Accessories:** Do not crimp or swage any Parker Hose or Fitting with anything but the listed swage or crimp machine and dies in accordance with Parker published instructions. Do not crimp or swage another manufacturer's Fitting with a Parker crimp or swage die unless authorized in writing by the engineering manager or chief engineer of the appropriate Parker division.

**3.4 Parts:** Do not use any Parker Fitting part (including but not limited to socket, shell, nipple, or insert) except with the correct Parker mating parts, in accordance with Parker published instructions, unless authorized in writing by the engineering manager or chief engineer of the appropriate Parker division.

**3.5 Field Attachable/Permanent:** Do not reuse any field attachable Hose Fitting that has blown or pulled off a Hose. Do not reuse a Parker permanent Hose Fitting (crimped or swaged) or any part thereof. Complete Hose Assemblies may only be reused after proper inspection under section 4.0. Do not assemble Fittings to any previously used hydraulic Hose that was in service, for use in a fluid power application.

**3.6 Pre-Installation Inspection:** Prior to installation, a careful examination of the Hose Assembly

must be performed. Inspect the Hose Assembly for any damage or defects. DO NOT use any Hose Assembly that displays any signs of nonconformance.

**3.7 Minimum Bend Radius:** Installation of a Hose at less than the minimum listed bend radius may significantly reduce the Hose life. Particular attention must be given to preclude sharp bending at the Hose to Fitting juncture. Any bending during installation at less than the minimum bend radius must be avoided. If any Hose is kinked during installation, the Hose must be discarded.

**3.8 Twist Angle and Orientation:** Hose Assembly installation must be such that relative motion of machine components does not produce twisting.

**3.9 Securement:** In many applications, it may be necessary to restrain, protect, or guide the Hose to protect it from damage by unnecessary flexing, pressure surges, and contact with other mechanical components. Care must be taken to insure such restraints do not introduce additional stress or wear points.

**3.10 Proper Connection of Ports:** Proper physical installation of the Hose Assembly requires a correctly installed port connection insuring that no twist or torque is transferred to the Hose when the Fittings are being tightened or otherwise during use.

**3.11 External Damage:** Proper installation is not complete without insuring that tensile loads, side loads, kinking, flattening, potential abrasion, thread damage or damage to sealing surfaces are corrected or eliminated. See instruction 2.10.

**3.12 System Checkout:** All air entrapment must be eliminated and the system pressurized to the maximum system pressure (at or below the Hose maximum working pressure) and checked for proper function and freedom from leaks. Personnel must stay out of potential hazardous areas while testing and using.

**3.13 Routing:** The Hose Assembly should be routed in such a manner so if a failure does occur, the escaping media will not cause personal injury or property damage. In addition, if fluid media comes in contact with hot surfaces, open flame or sparks, a fire or explosion may occur. See section 2.4.

**3.14 Ground Fault Equipment Protection Devices (GFEPDs):** WARNING! Fire and Shock Hazard. To minimize the danger of fire if the heating cable of a Multitube bundle is damaged or improperly installed, use a Ground Fault Equipment Protection Device. Electrical fault currents may be insufficient to trip a conventional circuit breaker.

For ground fault protection, the IEEE 515: ([www.ansi.org](http://www.ansi.org)) standard for heating cables recommends the use of GFEPDs with a nominal 30 milliampere trip level for "piping systems in classified areas, those areas requiring a high degree of mainte-

# Parker Safety Guide

nance, or which may be exposed to physical abuse or corrosive atmospheres”.

## 4.0 TUBE AND FITTINGS ASSEMBLY AND INSTALLATION INSTRUCTIONS

**4.1 Component Inspection:** Prior to assembly, a careful examination of the Tube and Fittings must be performed. All components must be checked for correct style, size, material, seal, and length. Inspect the Fitting and sealing surfaces for burrs, nicks, corrosion, missing seal or other imperfections. Do NOT use any component that displays any signs of nonconformance.

**4.2 Tube and Fitting Assembly:** Do not assemble a Parker Fitting with a Tube that is not specifically listed by Parker for that Fitting, unless authorized in writing by the engineering manager or chief engineer of the appropriate Parker division. The Tube must meet the requirements specified to the Fitting. The Parker published instructions must be followed for assembling the Fittings to a Tube. These instructions are provided in the Parker Fitting catalog for the specific Parker Fitting being used, or by calling 1-800-CPARKER, or at [www.parker.com](http://www.parker.com).

**4.3 Related Accessories:** Do not preset or flange Parker Fitting components using another manufacturer's equipment or procedures unless authorized in writing by the engineering manager or chief engineer of the appropriate Parker division. Tube, Fitting component and tooling must be checked for correct style, size and material. Operation and maintenance of Related Accessories must be in accordance with the operation manual for the designated Accessory.

**4.4 Securement:** In many applications, it may be necessary to restrain, protect, or guide the Tube to protect it from damage by unnecessary flexing, pressure surges, vibration, and contact with other mechanical components. Care must be taken to insure such restraints do not introduce additional stress or wear points.

**4.5 Proper Connection of Ports:** Proper physical installation of the Tube Assembly requires a correctly installed port connection insuring that no torque is transferred to the Tube when the Fittings are being tightened or otherwise during use.

**4.6 External Damage:** Proper installation is not complete without insuring that tensile loads, side loads, flattening, potential abrasion, thread damage or damage to sealing surfaces are corrected or eliminated. See instruction 2.10.

**4.7 System Checkout:** All air entrapment must be eliminated and the system pressurized to the maximum system pressure (at or below the Tube Assembly maximum working pressure) and checked for proper function and freedom from leaks. Personnel must stay out of potential hazard-

ous areas while testing and using.

**4.8 Routing:** The Tube Assembly should be routed in such a manner so if a failure does occur, the escaping media will not cause personal injury or property damage. In addition, if fluid media comes in contact with hot surfaces, open flame or sparks, a fire or explosion may occur. See section 2.4.

## 5.0 HOSE AND FITTING MAINTENANCE AND REPLACEMENT INSTRUCTIONS

**5.1** Even with proper selection and installation, Hose life may be significantly reduced without a continuing maintenance program. The severity of the application, risk potential from a possible Hose failure, and experience with any Hose failures in the application or in similar applications should determine the frequency of the inspection and the replacement for the Products so that Products are replaced before any failure occurs. Certain products require maintenance and inspection per industry requirements. Failure to adhere to these requirements may lead to premature failure. A maintenance program must be established and followed by the user and, at minimum, must include instructions 5.2 through 5.7

**5.2 Visual Inspection Hose/Fitting:** Any of the following conditions require immediate shut down and replacement of the Hose Assembly:

- Fitting slip on Hose;
- Damaged, cracked, cut or abraded cover (any reinforcement exposed);
- Hard, stiff, heat cracked, or charred Hose;
- Cracked, damaged, or badly corroded Fittings;
- Leaks at Fitting or in Hose;
- Kinked, crushed, flattened or twisted Hose; and
- Blistered, soft, degraded, or loose cover.

**5.3 Visual Inspection All Other:** The following items must be tightened, repaired, corrected or replaced as required:

- Leaking port conditions;
- Excess dirt buildup;/
- Worn clamps, guards or shields; and
- System fluid level, fluid type, and any air entrapment.

**5.4 Functional Test:** Operate the system at maximum operating pressure and check for possible malfunctions and leaks. Personnel must avoid potential hazardous areas while testing and using the system. See section 2.2.

**5.5 Replacement Intervals:** Hose assemblies and elastomeric seals used on Hose Fittings and adapters will eventually age, harden, wear and deteriorate under thermal cycling and compression set. Hose Assemblies and elastomeric seals should be inspected and replaced at specific replacement intervals, based on previous service life, government or industry recommendations, or when failures could result in unacceptable downtime, damage, or injury risk. See section 1.2. Hose and Fittings may be subjected to internal

Hose  
A

Fittings  
B

Adapters & Valves  
C

Quick Couplings  
D

Accessories  
E

General Technical  
F

# Parker Safety Guide

mechanical and/or chemical wear from the conveying fluid and may fail without warning. The user must determine the product life under such circumstances by testing. Also see section 2.5.

**5.6 Hose Inspection and Failure:** Hydraulic power is accomplished by utilizing high pressure fluids to transfer energy and do work. Hoses, Fittings and Hose Assemblies all contribute to this by transmitting fluids at high pressures. Fluids under pressure can be dangerous and potentially lethal and, therefore, extreme caution must be exercised when working with fluids under pressure and handling the Hoses transporting the fluids. From time to time, Hose Assemblies will fail if they are not replaced at proper time intervals. Usually these failures are the result of some form of misapplication, abuse, wear or failure to perform proper maintenance. When Hoses fail, generally the high pressure fluids inside escape in a stream which may or may not be visible to the user. Under no circumstances should the user attempt to locate the leak by "feeling" with their hands or any other part of their body. High pressure fluids can and will penetrate the skin and cause severe tissue damage and possibly loss of limb. Even seemingly minor hydraulic fluid injection injuries must be treated immediately by a physician with knowledge of the tissue damaging properties of hydraulic fluid.

If a Hose failure occurs, immediately shut down the equipment and leave the area until pressure has been completely released from the Hose Assembly. Simply shutting down the hydraulic pump may or may not eliminate the pressure in the Hose Assembly. Many times check valves, etc., are employed in a system and can cause pressure to remain in a Hose Assembly even when pumps or equipment are not operating. Tiny holes in the Hose, commonly known as pinholes, can eject small, dangerously powerful but hard to see streams of hydraulic fluid. It may take several minutes or even hours for the pressure to be relieved so that the Hose Assembly may be examined safely.

Once the pressure has been reduced to zero, the Hose Assembly may be taken off the equipment and examined. It must always be replaced if a failure has occurred. Never attempt to patch or repair a Hose Assembly that has failed. Consult the nearest Parker distributor or the appropriate Parker division for Hose Assembly replacement information.

Never touch or examine a failed Hose Assembly unless it is obvious that the Hose no longer contains fluid under pressure. The high pressure fluid is extremely dangerous and can cause serious and potentially fatal injury.

**5.7 Elastomeric seals:** Elastomeric seals will eventually age, harden, wear and deteriorate under thermal cycling and compression set. Elastomeric seals should be inspected and replaced.

**5.8 Refrigerant gases:** Special care should be taken when working with refrigeration systems. Sudden escape of refrigerant gases can cause blindness if the escaping gases contact the eye and can cause freezing or other severe injuries if it contacts any other portion of the body.

**5.9 Compressed natural gas (CNG):** Parker CNG Hose Assemblies should be tested after installation and before use, and at least on a monthly basis per instructions provided on the Hose Assembly tag. The recommended procedure is to pressurize the Hose and check for leaks and to visually inspect the Hose for damage and to perform an electrical resistance test.

Caution: Matches, candles, open flame or other sources of ignition shall not be used for Hose inspection. Leak check solutions should be rinsed off after use.

## 6.0 HOSE STORAGE

**6.1 Age Control:** Hose and Hose Assemblies must be stored in a manner that facilitates age control and first-in and first-out usage based on

manufacturing date of the Hose and Hose Assemblies. Unless otherwise specified by the manufacturer or defined by local laws and regulations:

**6.1.1** The shelf life of rubber hose in bulk form or hose made from two or more materials is 28 quarters (7 years) from the date of manufacture, with an extension of 12 quarters (3 years), if stored in accordance with ISO 2230;

**6.1.2** The shelf life of thermoplastic and polytetrafluoroethylene hose is considered to be unlimited;

**6.1.3** Hose assemblies that pass visual inspection and proof test shall not be stored for longer than 2 years.

**6.1.4 Storage:** Stored Hose and Hose Assemblies must not be subjected to damage that could reduce their expected service life and must be placed in a cool, dark and dry area with the ends capped. Stored Hose and Hose Assemblies must not be exposed to temperature extremes, ozone, oils, corrosive liquids or fumes, solvents, high humidity, rodents, insects, ultraviolet light, electromagnetic fields or radioactive materials.



# Offer of Sale

**1. Definitions.** As used herein, the following terms have the meanings indicated.

**Buyer:** means any customer receiving a Quote for Products from Seller.

**Goods:** means any tangible part, system or component to be supplied by the Seller.

**Products:** means the Goods, Services and/or Software as described in a Quote provided by the Seller.

**Quote:** means the offer or proposal made by Seller to Buyer for the supply of Products.

**Seller:** means Parker-Hannifin Corporation, including all divisions and businesses thereof.

**Services:** means any services to be supplied by the Seller.

**Software:** means any software related to the Products, whether embedded or separately downloaded.

**Terms:** means the terms and conditions of this Offer of Sale or any newer version of the same as published by Seller electronically at [www.parker.com/salesterms](http://www.parker.com/salesterms).

**2. Terms.** All sales of Products by Seller are contingent upon, and will be governed by, these Terms and, these Terms are incorporated into any Quote provided by Seller to any Buyer. Buyer's order for any Products whether communicated to Seller verbally, in writing, by electronic date interface or other electronic commerce, shall constitute acceptance of these Terms. Seller objects to any contrary or additional terms or conditions of Buyer. Reference in Seller's order acknowledgement to Buyer's purchase order or purchase order number shall in no way constitute an acceptance of any of Buyer's terms of purchase. No modification to these Terms will be binding on Seller unless agreed to in writing and signed by an authorized representative of Seller.

**3. Price; Payment.** The Products set forth in Seller's Quote are offered for sale at the prices indicated in Seller's Quote. Unless otherwise specifically stated in Seller's Quote, prices are valid for thirty (30) days and do not include any sales, use, or other taxes or duties. Seller reserves the right to modify prices at any time to adjust for any raw material price fluctuations. Unless otherwise specified by Seller, all prices are F.C.A. Seller's facility (INCOTERMS 2010). All sales are contingent upon credit approval and payment for all purchases is due thirty (30) days from the date of invoice (or such date as may be specified in the Quote). Unpaid invoices beyond the specified payment date incur interest at the rate of 1.5% per month or the maximum allowable rate under applicable law.

**4. Shipment; Delivery; Title and Risk of Loss.** All delivery dates are approximate. Seller is not responsible for damages resulting from any delay. Regardless of the manner of shipment, delivery occurs and title and risk of loss or damage pass to Buyer, upon placement of the Products with the shipment carrier at Seller's facility. Unless otherwise agreed, Seller may exercise its judgment in choosing the carrier and means of delivery. No deferral of shipment at Buyers' request beyond the respective indicated shipping date will be made except on terms that will indemnify, defend and hold Seller harmless against all loss and additional expense. Buyer shall be responsible for any additional shipping charges incurred by Seller due to Buyer's acts or omissions.

**5. Warranty.** The warranty related to the Products is as follows: (i) Goods are warranted against defects in material or workmanship for a period of twelve (12) months from the date of delivery or 2,000 hours of use, whichever occurs first; (ii) Services shall be performed in accordance with generally accepted practices and using the degree of care and skill that is ordinarily exercised and customary in the field to which the Services pertain and are warranted for a period of six (6) months from the completion of the Services by Seller; and (iii) Software is only warranted to perform in accordance with applicable specifications provided by Seller to Buyer for ninety (90) days from the date of delivery or, when downloaded by a Buyer or end-user, from the date of the initial download. All prices are based upon the exclusive limited warranty stated above, and upon the following disclaimer:

**DISCLAIMER OF WARRANTY:** THIS WARRANTY IS THE SOLE AND ENTIRE WARRANTY PERTAINING TO PRODUCTS. SELLER DISCLAIMS ALL OTHER WARRANTIES, EXPRESS AND IMPLIED, INCLUDING DESIGN, NON-INFRINGEMENT, MERCHANTABILITY, AND FITNESS FOR A PARTICULAR PURPOSE. SELLER DOES NOT WARRANT THAT THE SOFTWARE IS ERROR-FREE OR FAULT-TOLERANT, OR THAT BUYER'S USE THEREOF WILL BE SECURE OR UNINTERRUPTED. BUYER AGREES AND ACKNOWLEDGES THAT UNLESS OTHERWISE AUTHORIZED IN WRITING BY SELLER THE SOFTWARE SHALL NOT BE USED IN CONNECTION WITH HAZARDOUS OR HIGH RISK ACTIVITIES OR ENVIRONMENTS. EXCEPT AS EXPRESSLY STATED HEREIN, ALL PRODUCTS ARE PROVIDED "AS IS".

**6. Claims; Commencement of Actions.** Buyer shall promptly inspect all Products upon receipt. No claims for shortages will be allowed unless reported to the Seller within ten (10) days of delivery. Buyer shall notify Seller of any alleged breach of warranty within thirty (30) days after the date the non-conformance is or should have been discovered by Buyer. Any claim or action against Seller based upon breach of contract or any other theory, including tort, negligence, or otherwise must be commenced within twelve (12) months from the date of the alleged breach or other alleged event, without regard to the date of discovery.

**7. LIMITATION OF LIABILITY.** IN THE EVENT OF A BREACH OF WARRANTY, SELLER WILL, AT ITS OPTION, REPAIR OR REPLACE THE NON-CONFORMING PRODUCT, RE-PERFORM THE SERVICES, OR REFUND THE PURCHASE PRICE PAID WITHIN A REASONABLE PERIOD OF TIME. IN NO EVENT IS SELLER LIABLE FOR ANY SPECIAL, INDIRECT, INCIDENTAL OR CONSEQUENTIAL DAMAGES ARISING OUT OF, OR AS THE RESULT OF, THE SALE, DELIVERY, NON-DELIVERY, SERVICING, NON-COMPLETION OF SERVICES, USE, LOSS OF USE OF, OR INABILITY TO USE THE PRODUCTS OR ANY PART THEREOF, LOSS OF DATA, IDENTITY, PRIVACY, OR CONFIDENTIALITY, OR FOR ANY CHARGES OR EXPENSES OF ANY NATURE INCURRED WITHOUT SELLER'S WRITTEN CONSENT, WHETHER BASED IN CONTRACT, TORT OR OTHER LEGAL THEORY. IN NO EVENT SHALL SELLER'S LIABILITY UNDER ANY CLAIM MADE BY BUYER EXCEED THE PURCHASE PRICE PAID FOR THE PRODUCTS.

**8. Loss to Buyer's Property.** Any designs, tools, patterns, materials, drawings, confidential information or equipment furnished by Buyer or any other items which are or become Buyer's property, will be considered obsolete and may be destroyed by Seller after two (2) consecutive years have elapsed without Buyer ordering the Products manufactured using such property. Seller shall not be responsible for any loss or damage to such property while it is in Seller's possession or control.

**9. Special Tooling.** Special Tooling includes but is not limited to tooling, jigs, fixtures and associated manufacturing equipment acquired or necessary to manufacture Products. A tooling charge may be imposed for any Special Tooling. Such Special Tooling shall be and remain Seller's property notwithstanding payment of any charges by Buyer. In no event will Buyer acquire any interest in Special Tooling belonging to Seller that is utilized in the manufacture of the Products, even if such Special Tooling has been specially converted or adapted for such manufacture and notwithstanding any charges paid by Buyer. Unless otherwise agreed, Seller has the right to alter, discard or otherwise dispose of any Special Tooling or other property in its sole discretion at any time.

**10. Security Interest.** To secure payment of all sums due, Seller retains a security interest in all Products delivered to Buyer and, Buyer's acceptance of these Terms is deemed to be a Security Agreement under the Uniform Commercial Code. Buyer authorizes Seller as its attorney to execute and file on Buyer's behalf all documents Seller deems necessary to perfect its security interest.

**11. User Responsibility.** The Buyer through its own analysis and testing, is solely responsible for making the final selection of the Products and assuring that all performance, endurance, maintenance, safety and warning requirements of the application of the Products are met. The

A Hose  
B Fittings  
C Adapters & Valves  
D Quick Couplings  
E Accessories  
F General Technical

# Offer of Sale

Buyer must analyze all aspects of the application and follow applicable industry standards, specifications, and other technical information provided with the Product. If Seller provides Product options based upon data or specifications provided by the Buyer, the Buyer is responsible for determining that such data and specifications are suitable and sufficient for all applications and reasonably foreseeable uses of the Products. In the event the Buyer is not the end-user, Buyer will ensure such end-user complies with this paragraph.

**12. Use of Products, Indemnity by Buyer.** Buyer shall comply with all instructions, guides and specifications provided by Seller with the Products. Unauthorized Uses. If Buyer uses or resells the Products for any uses prohibited in Seller's instructions, guides or specifications, or Buyer otherwise fails to comply with Seller's instructions, guides and specifications, Buyer acknowledges that any such use, resale, or non-compliance is at Buyer's sole risk. Buyer shall indemnify, defend, and hold Seller harmless from any losses, claims, liabilities, damages, lawsuits, judgments and costs (including attorney fees and defense costs), whether for personal injury, property damage, intellectual property infringement or any other claim, brought by or incurred by Buyer, Buyer's employees, or any other person, arising out of: (a) improper selection, application, design, specification or other misuse of Products provided by Seller; (b) any act or omission, negligent or otherwise, of Buyer; (c) Seller's use of patterns, tooling, equipment, plans, drawings, designs or specifications or other information or things furnished by Buyer; (d) damage to the Products from an external cause, repair or attempted repair by anyone other than Seller, failure to follow instructions, guides and specifications provided by Seller, use with goods not provided by Seller, or opening, modifying, deconstructing or tampering with the Products for any reason; or (e) Buyer's failure to comply with these Terms. Seller shall not indemnify Buyer under any circumstance except as otherwise provided in these Terms.

**13. Cancellations and Changes.** Buyer may not cancel or modify any order for any reason, except with Seller's written consent and upon terms that will indemnify, defend and hold Seller harmless against all direct, incidental and consequential loss or damage. Seller, at any time, may change Product features, specifications, designs and availability.

**14. Limitation on Assignment.** Buyer may not assign its rights or obligations without the prior written consent of Seller.

**15. Force Majeure.** Seller does not assume the risk and is not liable for delay or failure to perform any of Seller's obligations by reason of events or circumstances beyond its reasonable control ("Events of Force Majeure"). Events of Force Majeure shall include without limitation: accidents, strikes or labor disputes, acts of any government or government agency, acts of nature, delays or failures in delivery from carriers or suppliers, shortages of materials, or any other cause beyond Seller's reasonable control.

**16. Waiver and Severability.** Failure to enforce any provision of these Terms will not invalidate that provision; nor will any such failure prejudice Seller's right to enforce that provision in the future. Invalidation of any provision of these Terms by legislation or other rule of law shall not invalidate any other provision herein and, the remaining provisions will remain in full force and effect.

**17. Termination.** Seller may terminate any agreement governed by or arising from these Terms for any reason and at any time by giving Buyer thirty (30) days prior written notice. Seller may immediately terminate, in writing, if Buyer: (a) breaches any provision of these Terms (b) appoints a trustee, receiver or custodian for all or any part of Buyer's property (c) files a petition for relief in bankruptcy on its own behalf, or one if filed by a third party (d) makes an assignment for the benefit of creditors; or (e) dissolves its business or liquidates all or a majority of its assets.

**18. Ownership of Software.** Seller retains ownership of all Software supplied to Buyer hereunder. In no event shall Buyer obtain any greater right in and to the Software than a right in the nature of a license limited to the use thereof and subject to compliance with any other terms provided with the Software.

**19. Indemnity for Infringement of Intellectual Property Rights.** Seller is not liable for infringement of any patents, trademarks, copyrights, trade dress, trade secrets or similar rights ("Intellectual Property Rights") except as provided in this Section. Seller will defend at its expense and will pay the cost of any settlement or damages awarded in an action brought against Buyer based on a third party claim that one or more of the Products sold hereunder infringes the Intellectual Property Rights of a third party in the country of delivery of the Products by the Seller to the Buyer. Seller's obligation to defend and indemnify Buyer is contingent on Buyer notifying Seller within ten (10) days after Buyer becomes aware of any such claim, and Seller having sole control over the defense of the claim including all negotiations for settlement or compromise. If one or more Products sold hereunder is subject to such a claim, Seller may, at its sole expense and option, procure for Buyer the right to continue using the Products, replace or modify the Products so as to render them non-infringing, or offer to accept return of the Products and refund the purchase price less a reasonable allowance for depreciation. Seller has no obligation or liability for any claim of infringement: (i) arising from information provided by Buyer; or (ii) directed to any Products provided hereunder for which the designs are specified in whole or part by Buyer; or (iii) resulting from the modification, combination or use in a system of any Products provided hereunder. The foregoing provisions of this Section constitute Seller's sole and exclusive liability and Buyer's sole and exclusive remedy for such claims of infringement of Intellectual Property Rights.

**20. Governing Law.** These Terms and the sale and delivery of all Products are deemed to have taken place in, and shall be governed and construed in accordance with, the laws of the State of Ohio, as applicable to contracts executed and wholly performed therein and without regard to conflicts of laws principles. Buyer irrevocably agrees and consents to the exclusive jurisdiction and venue of the courts of Cuyahoga County, Ohio with respect to any dispute, controversy or claim arising out of or relating to the sale and delivery of the Products.

**21. Entire Agreement.** These Terms, along with the terms set forth in the main body of any Quote, forms the entire agreement between the Buyer and Seller and constitutes the final, complete and exclusive expression of the terms of sale. In the event of a conflict between any term set forth in the main body of a Quote and these Terms, the terms set forth in the main body of the Quote shall prevail. All prior or contemporaneous written or oral agreements or negotiations with respect to the subject matter shall have no effect. These Terms may not be modified unless in writing and signed by an authorized representative of Seller.

**22. Compliance with Laws.** Buyer agrees to comply with all applicable laws, regulations, and industry and professional standards, including those of the United States of America, and the country or countries in which Buyer may operate, including without limitation the U.S. Foreign Corrupt Practices Act ("FCPA"), the U.S. Anti-Kickback Act ("Anti-Kickback Act"), U.S. and E.U. export control and sanctions laws ("Export Laws"), the U.S. Food Drug and Cosmetic Act ("FDCA"), and the rules and regulations promulgated by the U.S. Food and Drug Administration ("FDA"), each as currently amended. Buyer agrees to indemnify, defend, and hold harmless Seller from the consequences of any violation of such laws, regulations and standards by Buyer, its employees or agents. Buyer acknowledges that it is familiar with all applicable provisions of the FCPA, the Anti-Kickback Act, Export Laws, the FDCA and the FDA and certifies that Buyer will adhere to the requirements thereof and not take any action that would make Seller violate such requirements. Buyer represents and agrees that Buyer will not make any payment or give anything of value, directly or indirectly, to any governmental official, foreign political party or official thereof, candidate for foreign political office, or commercial entity or person, for any improper purpose, including the purpose of influencing such person to purchase Products or otherwise benefit the business of Seller. Buyer further represents and agrees that it will not receive, use, service, transfer or ship any Product from Seller in a manner or for a purpose that violates Export Laws or would cause Seller to be in violation of Export Laws.

5/2017

# Part Number Index

115 Coupler.....	D-13	15KP01.....	C-42	1TM2X.....	B-74
115 Nipple.....	D-14	15Y8X.....	B-21	1TMBL.....	B-74
116 Coupler.....	D-15	16Y2X.....	B-10	1TMBS.....	B-74
116 Nipple.....	D-16	1922X.....	B-11	1TMKY.....	B-74
125 Coupler.....	D-17	1923X.....	B-12	1Y25X.....	B-15
125 Nipple.....	D-17	1928X.....	B-20	1Y28X.....	B-23
216.....	E-3	192LX.....	B-48	1Y2LX.....	B-54
220.....	E-3	19G8X.....	B-19	1Y2UX.....	B-64
412.....	E-3	19GE3.....	B-35	1Y42X.....	B-11
508.....	E-3	19GE4.....	B-35	1Y4KY.....	B-44
510.....	E-3	19M8X.....	B-20	1Y4LX.....	B-55
520.....	E-3	19ME3.....	B-34	1YHLX.....	B-56
620.....	E-3	19ME4.....	B-34	1YHTX.....	B-63
01D9.....	C-39	19W8X.....	B-20	201RX.....	B-60
02D9.....	C-40	19WE3.....	B-34	2020N.....	A-18
02Y5.....	C-32	19WE4.....	B-34	2022N.....	A-20
02Y6.....	C-38	1AY2X.....	B-10	206RX.....	B-60
106E3.....	B-36	1AY5X.....	B-14	2240D.....	A-22
137E3.....	B-36	1AY8X.....	B-22	2240N.....	A-62, A-64
139E3.....	B-35	1AYBL.....	B-28		
106E4.....	B-36	1AYBS.....	B-29	2248D.....	A-22
137E4.....	B-36	1AYCX.....	B-33	2248N.....	A-64
139E4.....	B-35	1AYJX.....	B-42	2380N.....	A-26, A-28
1018X.....	B-17	1AYKY.....	B-43	2380N...W.....	A-26
101BL.....	B-27	1AYLX.....	B-49	2388N.....	A-30
101BS.....	B-29	1AYTX.....	B-63	2388N...W.....	A-30
101EX.....	B-37	1AYUX.....	B-64	2390N.....	A-32
101HP.....	B-39	1C38X.....	B-22	2440D.....	A-34
101KY.....	B-43	1C93X.....	B-13	2440M.....	A-68
101LX.....	B-45	1C98X.....	B-22	2440N.....	A-36, A-38, A-62
101NX.....	B-57	1C9BL.....	B-28	2448D.....	A-34
101TX.....	B-61	1C9BS.....	B-30	2448M.....	A-68
1028X.....	B-17	1C9CX.....	B-33	2448N.....	A-38, A-60
102TX.....	B-62	1C9EX.....	B-38	2580M.....	A-66
1063X.....	B-12	1C9JX.....	B-42	2580N.....	A-40, A-60
1068X.....	B-18	1C9LX.....	B-51	2640D.....	A-42
106EX.....	B-37	1D98X.....	B-23	2640M.....	A-66, A-68
106HP.....	B-39	1HE5X.....	B-69	2640N.....	A-44, A-58, A-62
106HV.....	B-40	1HECX.....	B-70	2648N.....	A-44, A-60
106LX.....	B-47	1HELX.....	B-70	2740D.....	A-46
106NX.....	B-58	1HES6.....	B-70	2748D.....	A-46
106TX.....	B-62	1HETX.....	B-71	2749D.....	A-46
10K06-**-CAP.....	C-46	1HN5X.....	B-72	2840D.....	A-48
10KP01.....	C-42	1HNCX.....	B-73	2848D.....	A-48
10KP03.....	C-46	1HNLX.....	B-72	2849D.....	A-50
1378X.....	B-19	1HNS6.....	B-72	2TURX.....	B-60
1398X.....	B-19	1HNTX.....	B-73	57CR.....	A-54
15K02-**-CAP.....	C-42	1MB8X.....	B-23	5Y**-CAP.....	C-20

A Hose  
 B Fittings  
 C Adapters & Valves  
 D Quick Couplings  
 E Accessories  
**F General Technical**

# Part Number Index

5Y01.....	C-31	6YHLX.....	B-55	MHDC.....	E-3
5Y02.....	C-34	6YMWX.....	B-66	MK022.....	E-4
5Y5Y.....	C-17	6YY5.....	C-14	MSG.....	E-3
5Y6Y.....	C-18	6YY6.....	C-21	MTM04T.....	E-5
5YY5.....	C-12	80C.....	E-5	PVC.....	E-3
5YY6.....	C-15	83C.....	E-5	SV5Y.....	C-48
6015X.....	B-67	AV5Y.....	C-48	SV6Y.....	C-50
6018X.....	B-16	AV6Y.....	C-50	T5Y.....	C19
6019X.....	B-24	AY**-CAP.....	C-10	T6Y.....	C-23
601EX.....	B-37	C09.....	D-18	TFTF.....	B-74
601LX.....	B-46	C19.....	D-18	TMCAP.....	B-74
601NX.....	B-57	CV5Y.....	C-49	TV15Y.....	C-49
6068X.....	B-18	CV6Y.....	C-52	TV16Y.....	C-51
6069X.....	B-25	G214.....	E-5	TV25Y.....	C-49
606CR.....	B-31	HAHM4BM4.....	D-18	TV26Y.....	C-51
606LX.....	B-46	HBPHM.....	C-24	X5Y.....	C19
606NX.....	B-58	HBPLM.....	C20	X6Y.....	C-24
65Y LX.....	B-48	HCR.....	A-52	X6Y6.....	C-22
65Y8X.....	B-21	HP.....	A-56	Y204.....	C-20
66A5X.....	B-67	HP006 Coupler.....	D-6	Y206.....	C-20
66ACR.....	B-31, B-32	HP006 Nipple w/o Check Valve.....	D-7	Y209.....	C-20
66Y LX.....	B-48	HP006 Nipple w/Check Valve.....	D-8	Y212.....	C-20
68K5X.....	B-68	HP010 Coupler.....	D-9	Y216.....	C-20
692LX.....	B-47	HP010 Nipple w/o Check Valve.....	D-10	Y2C.....	C20
6AY5X.....	B-14	HP010 Nipple w/Check Valve.....	D-11	Y2N.....	C19
6AY8X.....	B-21	HP8.....	A-56	Y404, Y406, Y409.....	C-25
6AY9X.....	B-25	HPK.....	B-74	Y4C.....	C-24
6AY LX.....	B-50	K0101.....	C-27	Y4N.....	C-24
6AYNX.....	B-59	K0201.....	C-28	Y501.....	C-33
6AYWX.....	B-66	K0202.....	C-29	Y503.....	C-45
6C95X.....	B-14	K0203.....	C-39	Y5D9.....	C-16
6C9 LX.....	B-51	K0303.....	C-44	Y5Y5.....	C-13
6EZAX.....	B-26	K0306.....	C-44	Y5Y6.....	C-16
6HB5X.....	B-68	K0606.....	C-44	Y601.....	C-37
6HE5X.....	B-69	KCGL.....	C-25	Y603.....	C-46
6HELX.....	B-52	KL02.....	C-40	Y6D9.....	C-23
6HN5X.....	B-71	KT02.....	C-41	Y6TF.....	B-74
6HNLX.....	B-52	KX02.....	C-41	Y6Y6.....	C-22
6HY LX.....	B-53	L5Y.....	C-18	YA**-PLUG.....	C-10
6Y**-CAP.....	C-25	L6Y.....	C-23	YA01.....	C-30
6Y01.....	C-36	MBR.....	E-3	YA02.....	C-29
6Y02.....	C-35	MCG.....	E-4	YA03.....	C-45
6Y25X.....	B-15	MCGHS.....	E-4	YAD9.....	C-9
6Y2HX.....	B-41	MHBS.....	E-4	YAY1.....	C-10
6Y2 LX.....	B-53			YAY2.....	C-10
6Y4 LX.....	B-54			YAY5.....	C-9
6Y4WX.....	B-65			YAY6.....	C-8
6Y6Y.....	C-22			YAYA.....	C-8

















# Parker Fluid Connectors Group

## North American Divisions & Distribution Service Centers

**Your complete source** for quality tube fittings, hose & hose fittings, brass & composite fittings, quick-disconnect couplings, valves and assembly tools, locally available from a worldwide network of authorized distributors.

### **Fittings:**

Available in inch and metric sizes covering SAE, BSP, DIN, GAZ, JIS and ISO thread configurations, manufactured from steel, stainless steel, brass, aluminum, nylon and thermoplastic.

### **Hose, Tubing & Bundles:**

Available in a wide variety of sizes and materials including rubber, wire-reinforced, thermoplastic, hybrid and custom compounds.

### **Worldwide Availability:**

Parker operates Fluid Connectors manufacturing locations and sales offices throughout North America, South America, Europe and Asia-Pacific.

**For information**, call toll free...

**1-800-C-PARKER  
(1-800-272-7537)**

### **North American Divisions**

#### **Fluid System Connectors Division**

Otsego, MI  
phone 269 694 9411  
fax 269 694 4614

#### **Hose Products Division**

Wickliffe, OH  
phone 440 943 5700  
fax 440 943 3129

#### **Industrial Hose Division**

Wickliffe, OH  
phone 440 883 2120  
fax 440 833 2230

#### **Parflex Division**

Ravenna, OH  
phone 330 296 2871  
fax 330 296 8433

#### **Quick Coupling Division**

Minneapolis, MN  
phone 763 544 7781  
fax 763 544 3418

#### **Tube Fittings Division**

Columbus, OH  
phone 614 279 7070  
fax 614 279 7685

### **Distribution Service Centers**

#### **Buena Park, CA**

phone 714 522 8840  
fax 714 994 1183

#### **Conyers, GA**

phone 770 929 0330  
fax 770 929 0230

#### **Louisville, KY**

phone 502 937 1322  
fax 502 937 4180

#### **Portland, OR**

phone 503 283 1020  
fax 503 283 2201

#### **Toledo, OH**

phone 419 878 7000  
fax 419 878 7001  
fax 419 878 7420  
(FCG Kit Operations)

#### **Canada**

##### **Grimsby, ONT**

phone 905 945 2274  
fax 905 945 3945  
(Contact Grimsby for other Service Center locations.)

#### **Mexico**

##### **Toluca, MEX**

phone (52) 722 2754 200  
fax (52) 722 2722 168

Parker Hannifin Corporation

**Parflex Division**

11151 Cash Rd

Stafford, TX 77477

Phone 281.566.4500

Fax 281.582.5271

[www.parker.com/pfd](http://www.parker.com/pfd)

