

Mark 76 Series

On/Off Control Valves

For many control valve applications, a modulating, linear style valve is adequate. However, on/off control is more effective, or necessary, in some control valve processes. While many pneumatic, modulating control valves can be used for on/off service by supplying air pressure to the actuator in excess of the spring range they are sometimes an inappropriate solution to control a process. True on/off control valves, like the Mark 76, offer many advantages over this approach.

FUNCTION

The Mark 76 (1/2" - 2") typically functions using a 0 psi (0 bar), or 20 psi (1,4 bar) control signal. Through the use of a solenoid, either 0 psi or 20 psi is supplied to the actuator. Depending on the configuration of the sliding gate seats, 20 psi will either open or close the valve. When the solenoid is closed, and there is no pressure in the actuator, the spring in the actuator drives the valve to the pre-selected position.

FEATURES

- Extremely fast opening and closing times — The Mark 76 valve is able to achieve rapid control for two reasons. Like all sliding gate valve products, the MK76 has a very short stroke. In addition, the flow is straight through the valve and does not force the seats towards the open or closed position. This reduces the force required to move the valve, and in conjunction with the short stroke, minimizes the reaction time.
- Lower pressure requirements — Due to the sliding gate design, a low amount of force is needed to open and close the valve. This results in lower air supply pressure requirements, and smaller actuators than most valves require. The Mark 76 can achieve full opening or closing. Many other types of on/off valves require much greater actuator supply pressures, due to the fact that the valves must open or close against the pressure of the medium.
- Longevity — The Mark 76 provides the user with very long valve life, especially the actuator. Lab testing has shown that even after exceeding 10 million cycles, the MK76 displayed no visible wear on the diaphragm. Other design must use dynamic seals, which, due to greater stem displacement and higher actuator pressures, tend to wear out much faster.
- Steam application capability — In most valves, virtually all types of actuated valves have internal soft seats in the body/bonnet and seat areas. The temperature limits of these o-rings and gaskets often eliminate these valves from being used on steam applications, particularly at higher pressures, or with superheated steam. Since our sliding gate valves do not require soft seals, we can offer our Mark 76 for virtually all steam related on/off service. With the low friction Jorcote seat material, we are able to offer tight, and lasting, shutoff.

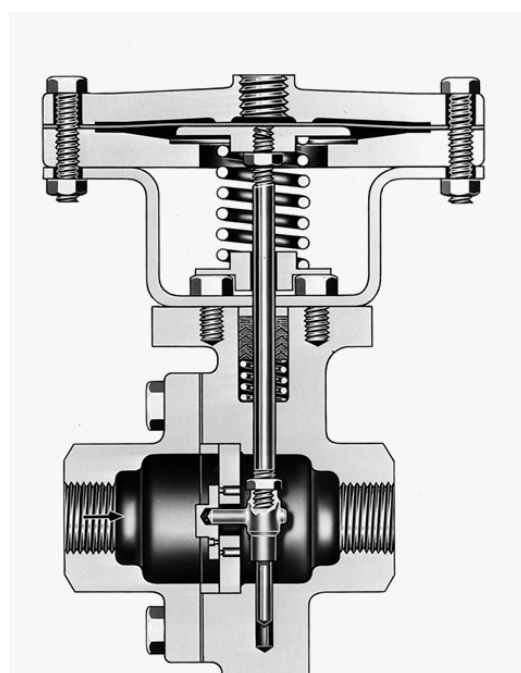

SPECIFICATIONS

Sizes: 1/4" through 6" (DN8 through DN150)
Note: 1/4" & 3/8" sizes use 1/2" body with reducers.

End Connections

- Threaded (NPT, BSPT, BSPP – through 2" (DN50) sizes)
- ANSI Flanges (150#, 300#)
- DIN Flanges (PN 10/16, PN25/40)

Body Materials

- Ductile Iron
- Bronze (1/2" - 2", DN15 - DN50)
- Carbon Steel (WCB)
- Stainless Steel (CF8M)

Trim Materials

- 303SS for CI and DI body valves
- 316SS for SS body valves

Seat Materials

- Jorcote on SST – Standard
- Chrome Plated SST – Option for light duty service (1/2" - 2", DN15 - DN50 only)

Yoke Material: Cast Iron

Actuator: Steel

Diaphragm: Buna-N (standard, to 200°F; 93,3°C)

Stem Packing: spring-loaded Teflon (to 450°F; 232°C)

Service: Steam, water, oil, gas, air and chemicals

Shutoff: ANSI Class IV

Ranges: operated with 20 psi (1,38 bar) for 1/2" through 2" sizes (DN15 through DN50); 50 psi (3,45 bar) for 2-1/2" through 6" sizes (DN65 through DN15)

Action:

- Direct (air signal closes valve)
- Reverse (air signal opens valve)

Cv Values and Maximum Allowable Differential

Pressure Rating

(Standard actuator: 1/2" - 2": 506; 2-1/2" - 6": 35M)

Flow Coef.		Valve Size (DN)	Seat Material	Max ΔP	
Cv	Kv			PSI	BAR
2.5 or 4.4	2,2 or 3,8	1/2" & 3/4" (DN15 & 20)	SST	125	8,6
			Jorcote	400	27,6
6.4 or 9.5	5,5 or 8,2	1" & 1-1/4" (DN25 & 32)	SST	100	6,9
			Jorcote	250	17,2
15	12,9	1-1/2" (DN40)	SST	75	5,2
			Jorcote	175	12,1
25 or 30	21,5 or 25,8	2" (DN50)	SST	75	5,2
			Jorcote	175	12,1
85	73,1	2-1/2" (DN65)	Jorcote	100	6,9
130	112	3" (DN80)	Jorcote	100	6,9
200	172	4" (DN100)	Jorcote	75	5,2
395	340	6" (DN150)	Jorcote	75	5,2

MAXIMUM WORKING PRESSURES & TEMPERATURES

Maximum Pressure @ 100°F, PSI/°F													
Size	Packing	DI Body			BRZ Body			CS Body			SST Body		
		150#	300#	TE	150#	300#	TE	150#	300#	TE	150#	300#	TE
1/2" to 2"	Any	250	640	988	225	500	500	285	740	1480	275	720	1440
2-1/2" to 6"	Any	250	640	—	—	—	—	285	740	—	275	720	—
Pressure @ Maximum Temperature, PSI/°F													
Any	TEF	170/450	495/450	808/450	150/450	325/450	325/450	170/450	600/450	1200/450	170/450	480/450	955/450
Maximum Pressure @ 38°C, BAR/°C													
Size	Packing	DI Body			BRZ Body			CS Body			SST Body		
		150#	300#	TE	150#	300#	TE	150#	300#	TE	150#	300#	TE
DN15 to 50	Any	17	44	68	225	16	34	20	51	102	19	50	99
DN65 to 150	Any	17	44	—	—	—	—	20	51	—	19	50	—
Pressure @ Maximum Temperature, BAR/°C													
Any	TEF	12/232	34/232	56/232	10/232	22/232	22/232	12/232	41/232	83/232	12/232	33/232	66/232

MARK 76 ON/OFF CONTROL VALVE

DIMENSIONS (1/2" - 2")

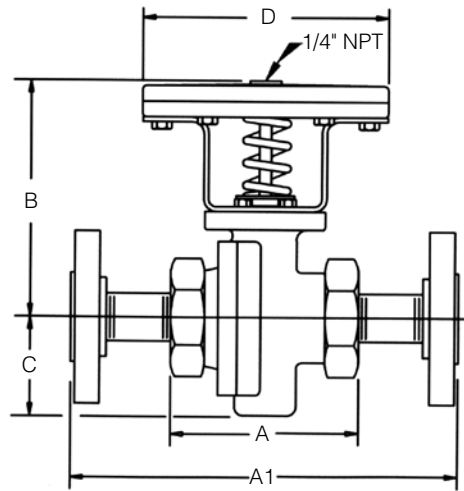

• Threaded Ends

Size	Material	Dimensions (inches)				Weight (lbs.)
		A	B	C	D	
1/2" & 3/4"	DI/BRZ	3.62	5.25	2.18	5.00	10
	CS/SS	3.65	5.25	2.18	5.00	10
1"	DI/BRZ	4.12	5.50	2.62	5.00	12
	CS/SS	4.12	5.50	2.62	5.00	13
1-1/4"	DI/BRZ	4.12	5.50	2.62	5.00	12
1-1/2"	DI/BRZ	4.50	5.75	2.62	5.00	13
	CS/SS	4.65	6.00	2.75	5.00	14
2"	DI/BRZ	4.50	5.87	2.62	5.00	15
	CS/SS	5.50	6.12	3.00	5.00	18

• Flanged Ends

Size	ANSI Flange	Dimensions (inches)				Weight (lbs.)
		A1	B	C	D	
1/2"	150#	7.25	5.25	2.18	5.00	12
	300#	7.50	5.25	2.18	5.00	14
3/4"	150#	7.25	5.25	2.18	5.00	14
	300#	7.62	5.25	2.18	5.00	16
1"	150#	7.25	5.50	2.62	5.00	16
	300#	7.75	5.50	2.62	5.00	19
1-1/4"	150#	7.87	5.50	2.62	5.00	16
	300#	8.37	5.50	2.62	5.00	20
1-1/2"	150#	8.75	6.00	2.75	5.00	25
	300#	9.25	6.00	2.75	5.00	26
2"	150#	10.00	6.12	3.00	5.00	29
	300#	10.50	6.12	3.00	5.00	32

• Threaded Ends, Metric

Size (DN)	Material	Dimensions (mm)				Weight (kgs.)
		A	B	C	D	
15 & 20	DI/BRZ	92	133	55	127	5,4
	CS/SS	93	133	55	127	5,4
25	DI/BRZ	105	140	67	127	6,4
	CS/SS	105	140	67	127	6,8
32	DI/BRZ	105	140	67	127	6,4
40	DI/BRZ	114	146	67	127	6,8
	CS/SS	118	152	70	127	7,3
50	DI/BRZ	114	149	67	127	7,7
	CS/SS	140	155	76	127	9,1

• Flanged Ends, Metric

Size (DN)	Flange (PN)	Dimensions (mm)				Weight (kgs.)
		A1	B	C	D	
15	10/16	184	133	55	127	5,4
	25/40	191	133	55	127	6,5
20	10/16	184	133	55	127	6,5
	25/40	194	133	55	127	7,3
25	10/16	184	140	67	127	7,3
	25/40	197	140	67	127	8,6
32	10/16	200	140	67	127	7,3
	25/40	213	140	67	127	9,1
40	10/16	222	152	70	127	11,3
	25/40	234	152	70	127	11,8
50	10/16	254	155	76	127	13,2
	25/40	267	155	76	127	14,5

MARK 76 ON/OFF CONTROL VALVE

DIMENSIONS (2-1/2" - 6")

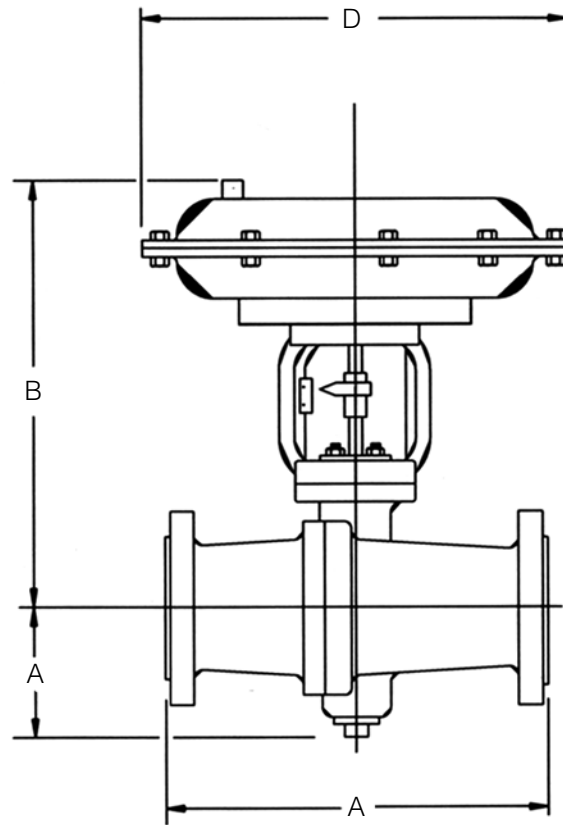

• **Flanged Ends**

Size	ANSI Flange	Dimensions (inches)				Weight (lbs.)
		A	B	C	D	
2-1/2"	125-150#	10.87	16.50	5.12	9.50	180
	250-300#	11.50	16.50	5.12	9.50	180
3"	125-150#	11.75	16.50	5.37	9.50	195
	250-300#	12.50	16.50	5.37	9.50	195
4"	125-150#	13.87	17.75	6.00	9.50	305
	250-300#	14.50	17.75	6.00	9.50	305
6"	125-150#	17.75	18.50	7.00	9.50	380
	250-300#	18.62	18.50	7.00	9.50	380

• **Flanged Ends, Metric**

Size (DN)	Flange (PN)	Dimensions (mm)				Weight (kgs.)
		A	B	C	D	
65	10/16	290	419	130	241	82
	25/40	290	419	130	241	82
80	10/16	310	419	136	241	88
	25/40	310	419	136	241	88
100	10/16	350	451	152	241	138
	25/40	350	451	152	241	138
150	10/16	480	470	178	241	172
	25/40	480	470	178	241	172

PRESSURE-TEMPERATURE CHARTS

• Ductile Iron

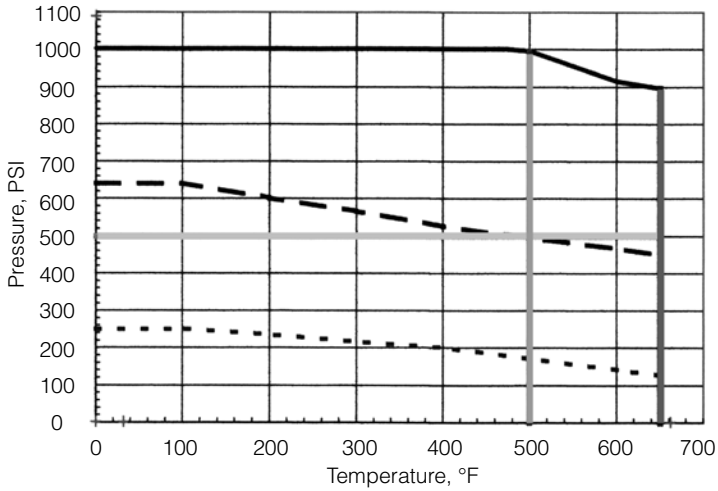

Ductile Iron Key

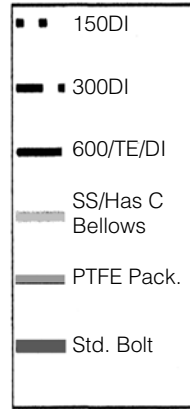

Stainless Steel Key



Carbon Steel Key

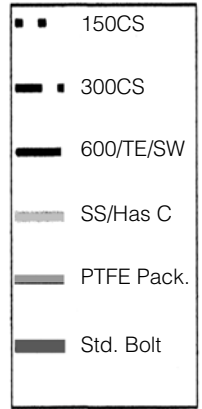

• Stainless Steel

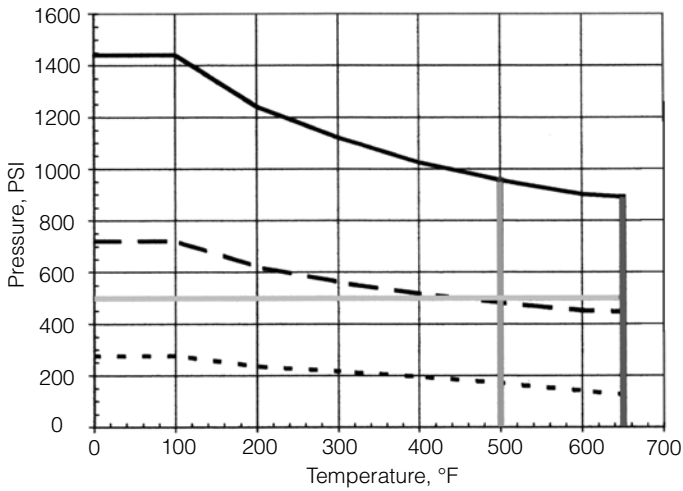

• Carbon Steel

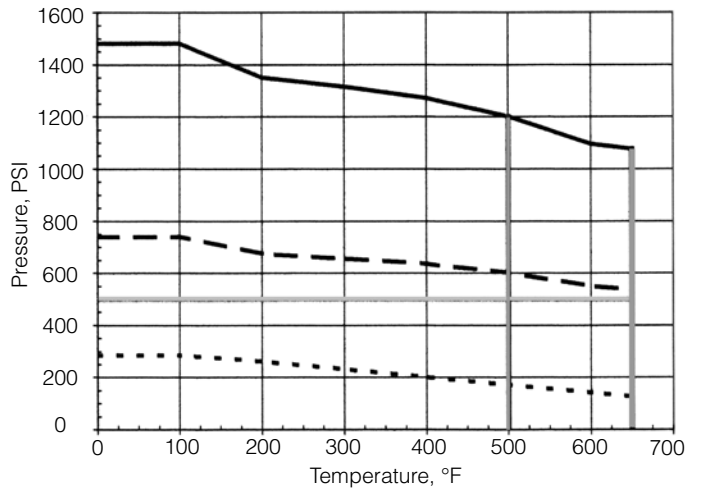

• Bronze

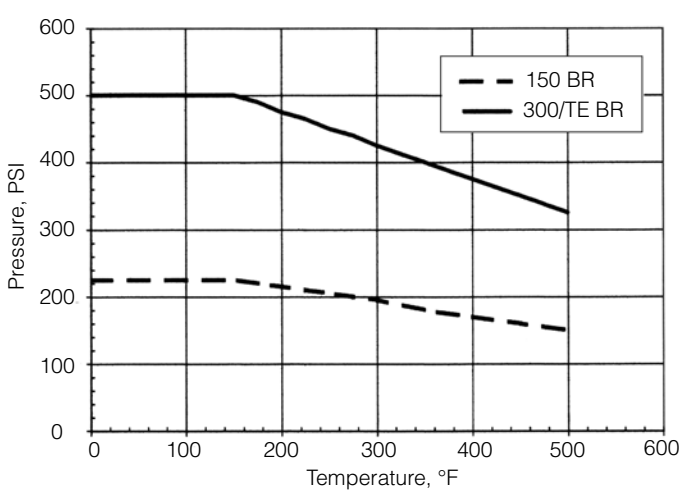

• Cast Iron

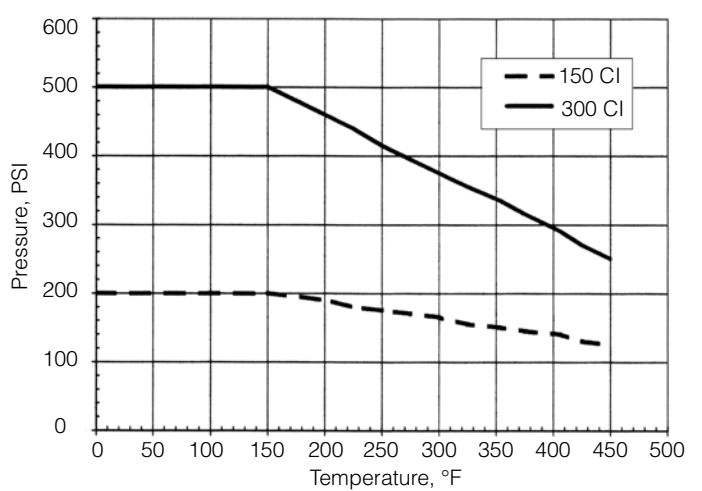

PRESSURE-TEMPERATURE CHARTS

• **Ductile Iron**

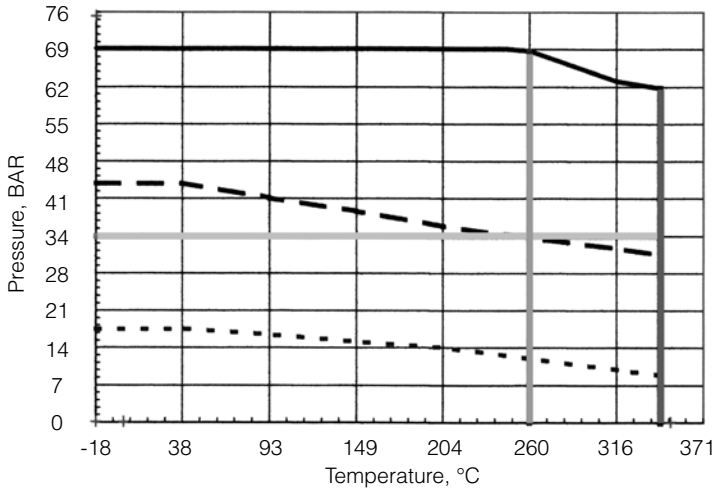

Ductile Iron Key

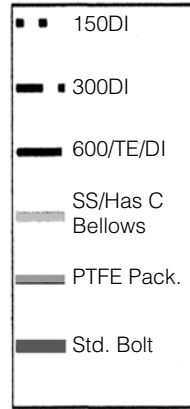

Stainless Steel Key

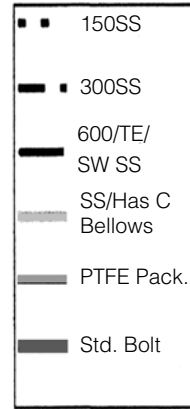

Carbon Steel Key

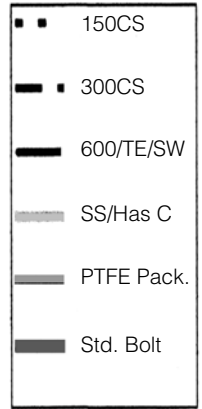

• **Stainless Steel**

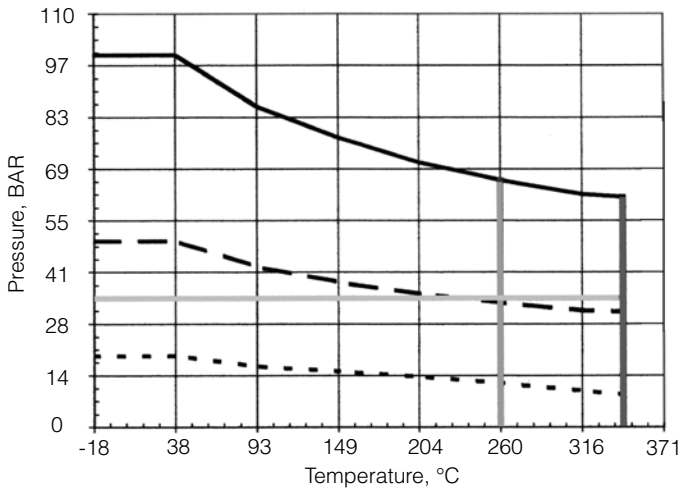

• **Carbon Steel**

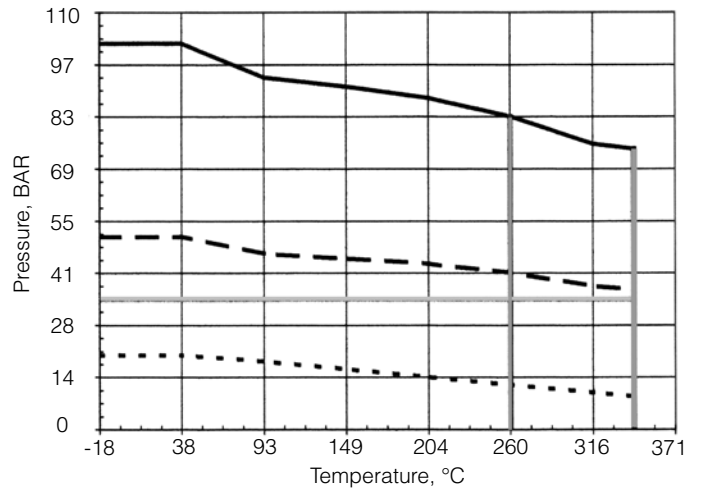

• **Bronze**

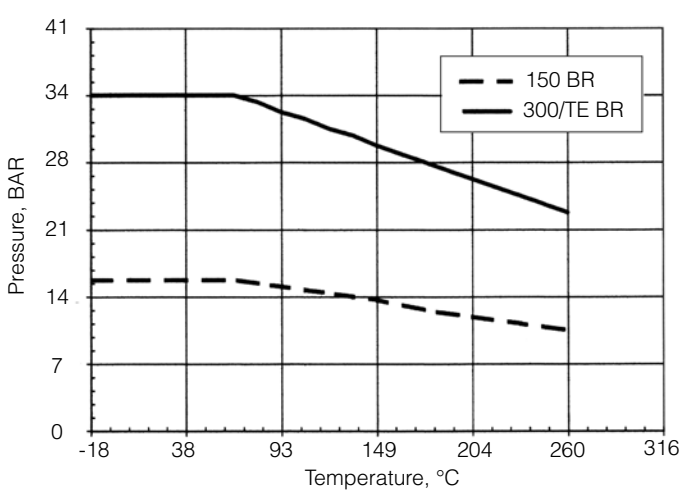

• **Cast Iron**

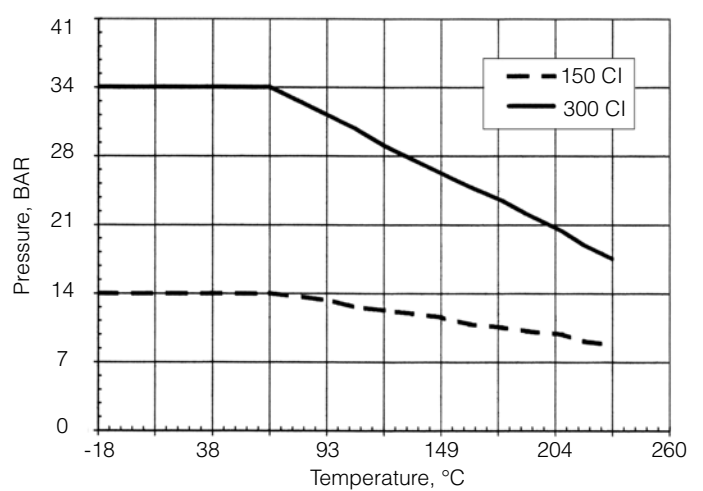

MARK 76 ON/OFF CONTROL VALVE

ORDERING SCHEMATIC

1		2		3	/	4	5	6	7	8	9	10	11	12	13	14	15

1	Model	
	76	On/Off Control Valve

2	Size	
	Inches	DN
	050	1/2"
	075	3/4"
	100	1"
	125	1-1/4"
	150	1-1/2"
	200	2"
	250	2-1/2"
	300	3"
	400	4"
	600	6"

3	Body Material	
	DI	Ductile Iron
	BR	Bronze
	CS	Carbon Steel (WCB)
	S6	Stainless Steel (CF8M)

4	End Connections	
	PT	NPT
	BT	BSPT
	I5	150# FE
	F5	150# FE (except IFE)
	I7	PN10 DIN IFE
	F7	PN 10 FE (except IFE)
	I6	PN16 DIN IFE
	F6	PN16 FE (except IFE)
	BP	BSPP
	SW	FSW
	I3	300# IFE
	F3	300# FE (except IFE)
	I8	PN25 DIN IFE
	F8	PN25 FE (except IFE)
	I4	PN40 DIN IFE
	F4	PN40 FE (except IFE)
	I1	125# IFE
	F1	125# FE (except IFE)
	I2	250# IFE
	F2	250# FE (except IFE)

5	Trim	
	T3	303SS/TFE Pkg
	T6	316SS/TFE Pkg
	TM	Monel/TFE Pkg
	TA	Alloy 20/TFE Pkg
	TH	Hastelloy C/TFE Pkg

6	Seat Material	
	A	303 SST
	B	316 SST
	Q	303/Teflon
	R	316/Teflon
	S	Monel/Teflon
	T	AL20/Teflon
	U	Hastelloy C/Teflon
	V	303SS/Jorcote
	W	316SS/Jorcote
	1	303 SST with Std W.H.
	2	316 SST with Std W.H.

7	Seat Cv	
	1	0.21
	2	0.42
	3	0.84
	4	1.6
	5	2.5
	6	4.4
	7	6.4
	8	9.5
	9	15.0
	A	25
	B	30
	C	50
	F	85
	G	115
	H	130
	I	200
	J	395

ORDERING SCHEMATIC (CONT'D)

8	Range	
	00	None

9	Diaphragm			
	Material		Size	
	B	Buna-N	3	35MM
	V	Viton	6	506
	B	Buna-N	6	506

10	Actuator			
	Material		Size	
	A	Standard	6	506 (1/4" - 2")
			3	35MM (2-1/2" - 6")

11	Accessories	
	00	None
	AR	Air Regulator
	S2	3-Way Solenoid Energize to Open
	S3	3-Way Solenoid Energize to Close
	X2	3-Way Solenoid X-Proof Energize to Open
	X3	3-Way Solenoid X-Proof Energize to Close

12	Action	
	D	Air-to-Close
	R	Air-to-Open

13	PED Compliance	
	0	Not Required
	F	CE Category 1

